

# Reproduction, Maturation, and Seed Production of Cultured Species

*Proceedings of the Twelfth  
U.S.-Japan Meeting on Aquaculture,  
Baton Rouge, Louisiana,  
October 25-29, 1983*

Carl J. Sindermann (Editor)

---



U.S. DEPARTMENT OF COMMERCE  
National Oceanic and Atmospheric Administration  
National Marine Fisheries Service

## NOAA TECHNICAL REPORT NMFS

The major responsibilities of the National Marine Fisheries Service (NMFS) are to monitor and assess the abundance and geographic distribution of fishery resources, to understand and predict fluctuations in the quantity and distribution of these resources, and to establish levels for their optimum use. NMFS is also charged with the development and implementation of policies for managing national fishing grounds, development and enforcement of domestic fisheries regulations, surveillance of foreign fishing off United States coastal waters, and the development and enforcement of international fishery agreements and policies. NMFS also assists the fishing industry through marketing service and economic analysis programs, and mortgage insurance and vessel construction subsidies. It collects, analyzes, and publishes statistics on various phases of the industry.

The NOAA Technical Report NMFS series was established in 1983 to replace two subcategories of the Technical Reports series: "Special Scientific Report—Fisheries" and "Circular." The series contains the following types of reports: Scientific investigations that document long-term continuing programs of NMFS; intensive scientific reports on studies of restricted scope; papers on applied fishery problems; technical reports of general interest intended to aid conservation and management; reports that review in considerable detail and at a high technical level certain broad areas of research; and technical papers originating in economics studies and from management investigations. Since this is a formal series, all submitted papers receive peer review and those accepted receive professional editing before publication.

Copies of NOAA Technical Reports NMFS are available free in limited numbers to governmental agencies, both Federal and State. They are also available in exchange for other scientific and technical publications in the marine sciences. Individual copies may be obtained from: U.S. Department of Commerce, National Technical Information Service, 5285 Port Royal Road, Springfield, VA 22161. Although the contents have not been copyrighted and may be reprinted entirely, reference to source is appreciated.

13. Guidelines for reducing porpoise mortality in tuna purse seining, by James M. Coe, David B. Holts, and Richard W. Butler. September 1984, 16 p.
14. Synopsis of biological data on shortnose sturgeon, *Acipenser brevirostrum* LeSueur 1818, by Michael J. Dadswell, Bruce D. Taubert, Thomas S. Squiers, Donald Marchette, and Jack Buckley. October 1984, 45 p.
15. Chaetognatha of the Caribbean sea and adjacent areas, by Harding B. Michel. October 1984, 33 p.
16. Proceedings of the Ninth and Tenth U.S.-Japan Meetings on Aquaculture, by Carl J. Sindermann (editor). November 1984, 92 p.
17. Identification and estimation of size from the beaks of 18 species of cephalopods from the Pacific Ocean, by Gary A. Wolff. November 1984, 50 p.
18. A temporal and spatial study of invertebrate communities associated with hard-bottom habitats in the South Atlantic Bight, by E. L. Wenner, P. Hinde, D. M. Knott, and R. F. Van Dolah. November 1984, 104 p.
19. Synopsis of biological data on spottail pinfish, *Diplodus holbrooki* (Pisces: Sparidae), by George H. Darcy. January 1985, 11 p.
20. Ichthyoplankton of the Continental Shelf near Kodiak Island, Alaska, by Arthur W. Kendall, Jr., and Jean R. Dunn. January 1985, 89 p.
21. Annotated bibliography on hypoxia and its effects on marine life, with emphasis on the Gulf of Mexico, by Maurice L. Renaud. February 1985, 9 p.
22. Congrid eels of the eastern Pacific and key to their Leptocephali, by Solomon N. Raju. February 1985, 19 p.
23. Synopsis of biological data on the pinfish, *Lagodon rhomboides* (Pisces:Sparidae), by George H. Darcy. February 1985, 32 p.
24. Temperature conditions in the cold pool 1977-81: A comparison between southern New England and New York transects, by Steven K. Cook. February 1985, 22 p.
25. Parasitology and pathology of marine organisms of the world ocean, by William J. Hargis, Jr. (editor). March 1985, 135 p.
26. Synopsis of biological data on the sand perch, *Diplectrum formosum* (Pisces: Serranidae), by George H. Darcy. March 1985, 21 p.
27. Proceedings of the Eleventh U.S.-Japan Meeting on Aquaculture, Salmon Enhancement, Tokyo, Japan, October 19-20, 1982, by Carl J. Sindermann (editor). March 1985, 102 p.
28. Review of geographical stocks of tropical dolphins (*Stenella* spp. and *Delphinus delphis*) in the eastern Pacific, by William F. Perrin, Michael D. Scott, G. Jay Walker, and Virginia L. Cass. March 1985, 28 p.
29. Prevalence, intensity, longevity, and persistence of *Anisakis* sp. larvae and *Lacis-torhynchus tenuis* metacestodes in San Francisco striped bass, by Mike Moser, Judy A. Sakanari, Carol A. Reilly, and Jeannette Whipple. April 1985, 4 p.
30. Synopsis of biological data on the pink shrimp, *Pandalus borealis* Krøyer, 1838, by Sandra E. Shumway, Herbert C. Perkins, Daniel F. Schick, and Alden P. Stickney. May 1985, 57 p.
31. Shark catches from selected fisheries off the U.S. east coast, by Emory D. Anderson, John G. Casey, John J. Hoey, and W. N. Witzell. July 1985, 22 p.
32. Nutrient Distributions for Georges Bank and adjacent waters in 1979, by A. F. J. Draxler, A. Matte, R. Waldhauer, and J. E. O'Reilly. July 1985, 34 p.
33. Marine flora and fauna of the Northeastern United States. Echinodermata: Echinoidea, by D. Keith Serafy and F. Julian Fell. September 1985, 27 p.
34. Additions to a revision of the shark genus *Carcharhinus*: Synonymy of *Aprionodon* and *Hypoprion*, and description of a new species of *Carcharhinus* (Carcharhinidae), by J. A. F. Garrick. November 1985, 26 p.
35. Synoptic review of the literature on the Southern oyster drill *Thais haemastoma floridana*, by Philip A. Butler. November 1985, 9 p.
36. An egg production method for estimating spawning biomass of pelagic fish: Application to the northern anchovy, *Engraulis mordax*, by Reuben Lasker (editor). December 1985, 99 p.
37. A histopathologic evaluation of gross lesions excised from commercially important North Atlantic marine fishes, by Robert A. Murchelano, Linda Despres-Patanjo, and John Ziskowski. March 1986, 14 p.
38. Fishery atlas of the northwestern Hawaiian Islands, by Richard N. Uchida and James H. Uchiyama (editors). September 1986, 142 p.
39. Survey of fish protective facilities at water withdrawal sites on the Snake and Columbia Rivers, by George A. Swan, Tommy G. Withrow, and Donn L. Park. April 1986, 34 p.
40. Potential impact of ocean thermal energy conversion (OTEC) on fisheries, by Edward P. Myers, Donald E. Hess, Walter M. Matsumoto, David S. Peters, Michael P. Seki, Richard N. Uchida, John D. Ditmars, and Robert A. Paddock. June 1986, 33 p.
41. A stationary visual census technique for quantitatively assessing community structure of coral reef fishes, by James A. Bohnsack and Scott P. Bannerot. July 1986, 15 p.
42. Effects of temperature on the biology of the northern shrimp, *Pandalus borealis*, in the Gulf of Maine, by Spencer Apollonio, David K. Stevenson, and Earl E. Dunton, Jr. September 1986, 22 p.
43. Environment and resources of seamounts in the North Pacific, by Richard N. Uchida, Sigeiti Hayasi, and George W. Boehlert (editors). September 1986, 105 p.
44. Synopsis of biological data on the porgies, *Calamus arcifrons* and *C. proridens* (Pisces: Sparidae), by George H. Darcy. September 1986, 19 p.
45. Meristic variation in *Sebastes* (Scorpaenidae), with an analysis of character association and bilateral pattern and their significance in species separation, by Lo-chai Chen. September 1986, 17 p.
46. Distribution and relative abundance of pelagic nonsalmonid nekton off Oregon and Washington 1979-84, by Richard D. Brodeur and William G. Pearcy. December 1986, 85 p.

NOAA Technical Report NMFS 47

## Reproduction, Maturation, and Seed Production of Cultured Species

Proceedings of the Twelfth  
U.S.-Japan Meeting on Aquaculture,  
Baton Rouge, Louisiana,  
October 25-29, 1983

Carl J. Sindermann (Editor)

Panel Chairmen:  
Conrad Mahnken, United States  
Takeshi Nose, Japan

*Under the U.S.-Japan Cooperative Program  
in Natural Resources (UJNR)*

February 1987



U.S. DEPARTMENT OF COMMERCE  
Malcolm Baldrige, Secretary  
National Oceanic and Atmospheric Administration  
Anthony J. Calio, Administrator  
National Marine Fisheries Service  
William E. Evans, Assistant Administrator for Fisheries

## PREFACE

The United States and Japanese counterpart panels on aquaculture were formed in 1969 under the United States-Japan Cooperative Program in Natural Resources (UJNR). The panels currently include specialists drawn from the federal departments most concerned with aquaculture. Charged with exploring and developing bilateral cooperation, the panels have focused their efforts on exchanging information related to aquaculture which could be of benefit to both countries.

The UJNR was begun during the Third Cabinet-Level Meeting of the Joint United States-Japan Committee on Trade and Economic Affairs in January 1964. In addition to aquaculture, current subjects in the program include desalination of seawater, toxic microorganisms, air pollution, energy, forage crops, national park management, mycoplasmosis, wind and seismic effects, protein resources, forestry, and several joint panels and committees in marine resources research, development, and utilization.

Accomplishments include: Increased communication and cooperation among technical specialists; exchanges of information, data, and research findings; annual meetings of the panels, a policy-coordinative body; administrative staff meetings; exchanges of equipment, materials, and samples; several major technical conferences; and beneficial effects on international relations.

Conrad Mahnken - United States  
Takeshi Nose - Japan

The National Marine Fisheries Service (NMFS) does not approve, recommend or endorse any proprietary product or proprietary material mentioned in this publication. No reference shall be made to NMFS, or to this publication furnished by NMFS, in any advertising or sales promotion which would indicate or imply that NMFS approves, recommends or endorses any proprietary product or proprietary material mentioned herein, or which has as its purpose an intent to cause directly or indirectly the advertised product to be used or purchased because of this NMFS publication.

# CONTENTS

---

**Fukuhara, Osamu**

Recent trends in mariculture and seed production of fish in southern Japan 1

**Yano, Isao**

Maturation of Kuruma prawns *Penaeus japonicus* cultured in earthen ponds 3

**Sanbonsuga, Yoshiaki**

Cultivation and seedling production of brown algae in Japan 9

**Fukuhara, Osamu**

Seed production of red sea bream *Pagrus major* (Sparidae) in Japan 13

**Melancon, Earl, Jr., Roanne Trapani, Greg Scott, and Len Bahr**

Culture of the oyster *Crassostrea virginica* (Gmelin) from seed to market on bedding reefs in Barataria Bay, Louisiana, U.S.A. 21

**Chatry, Mark**

Seed oyster production in Louisiana and prospects for enhancement 27

**Lawrence, Addison L., and Jay V. Huner**

Penaeid shrimp culture in the United States: A brief overview stressing species, seed production, and growout 31

**Cange, Stephen W., David L. Pavel, Mark S. Lamon, and James W. Avault, Jr.**

Development of larval rearing systems for the Malaysian prawn *Macrobrachium rosenbergii* in southern Louisiana 43

**Rhodes, Robert J., and James W. Avault, Jr.**

Changing sexual-state relationships of a population of red swamp crawfish *Procambarus clarkii* 51

**Rhodes, Robert J., and James W. Avault, Jr.**

A note on recruitment cycles for the red swamp crawfish *Procambarus clarkii* 53

**Wolters, William R.**

Production of triploid channel catfish fry 55

**Culley, Dudley D., Kirk A. Easley, Lynn Denson, Barbara A. Carr, and M. Arif Othman**

An investigation of potential ovulatory stimuli for the bullfrog *Rana catesbeiana* 59

**Lawson, Thomas B.**

Treatment of fish hatchery water for solids and turbidity removal 67



# Recent Trends in Mariculture and Seed Production of Fish in Southern Japan

OSAMU FUKUHARA

Nansei Regional Fisheries Research Laboratory  
Ohno-cho, Saeki-gun, Hiroshima 739-04, Japan

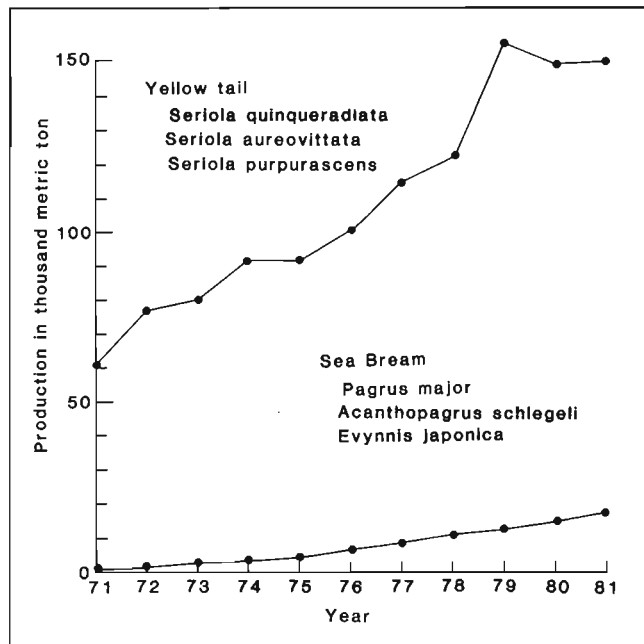

Figure 1—Annual production of three species each of yellowtail and red sea bream in mariculture, 1971-81. (Source: Statistics and Information Department, [Japan] Ministry of Agriculture, Forestry and Fisheries)

Marine aquaculture recently yielded more than 8% of the total fisheries production in Japan, ranging from 8.3 to 8.9% between 1977 and 1981. Yellowtail and sea bream are the major species in marine cage culture of fin-fish. Annual yield of yellowtail varied from 1.1 to 1.5% of the total fisheries production during the period 1977-81. However, yellowtail production from culture declined gradually for the past two years. This trend is a result of a shift in market preference for culture species, changing from yellowtail to other species, especially sparid fish. This trend is mainly due to the excessive production of yellowtail (Fig. 1), beyond the market demand.

More than 80% of yellowtail and sea bream are cultured in the southern areas of Japan. This paper describes briefly the recent trends in mariculture in southern Japan. Southern Japan is a prosperous area for the development of coastal aquaculture, with 18 prefectures facing the southwest waters of the Pacific Ocean (west from Wakayama), Seto Inland Sea, and East China Sea, where warm water masses of the Kuroshio and the Tsushima currents influence the coastal water temperatures (except for the central part of the Seto Inland Sea). The total production figures for the two species are compared in Table 1 with those for the southern areas of Japan. The total production of yellowtail increased continuously until 1979, and tended to decrease slightly thereafter. Production in southern Japan, however, increased steadily as did sea bream production, in total and in southern Japan.

Mass production of red sea bream (*Pagrus major*) started about a decade ago, which was the time of the beginning of farming fisheries. After establishing the rearing techniques for red sea bream, attempts were made to adapt the methodology to culture of other commercially important marine species such as black sea bream and Japanese parrot fish. Thereafter, marine fish rearing from eggs for stocking purposes prevailed among fisheries farmers, mainly those involved in net cage farming.

Presently about 20 species are reared in farming centers and in private hatcheries, mainly for net cage culture and/or planting of fish in coastal waters within the boundaries of the 18 prefectures of southern Japan. The farming centers concentrated their research efforts on improving the releasing techniques. Recently, planting of widely migrating fishes such as red sea bream has been carried on by the farming center of the central government, Japan Farming Fisheries Association. On the other hand, the farming centers of the prefectural governments, including the Fisheries Cooperative Associations, direct their efforts primarily towards the stocking of species that stay close to inshore areas of the prefectural coastal zone, so that they may be harvested by local fisherman in domestic waters.

The diversity of species produced through artificial propagation results from two causes: One is marketability of the product and the farmer's interest; the other is determined by the effective running of the rearing facilities. Basically the food habits of the Japanese people call for a variety of products, and preferences are not focused on one particular fish. This phenomenon favors diversification as soon as production techniques become available. Seed production is concentrated during spring and summer, and is rarely carried out during the winter season (Table 2). During winter, seed production of ayu, Japanese flounder, and mud dab is continued mainly at the farming centers and private hatcheries.

All fry of ayu are planted in rivers every year, and Japanese flounder are preferred for net cage culture among farmers due to fast growth and marketability.

**Table 1—Total annual production for 1977-81, and its percentage in southern Japan, of yellowtail and sea bream culture.**

Year	Yellowtail		Sea bream	
	Total (mt)	Southern Japan (%)	Total (mt)	Southern Japan (%)
1977	115,098	77.7	8,245	76.9
1978	121,956	80.7	11,315	80.0
1979	155,053	83.1	12,492	80.2
1980	149,449	84.9	14,973	81.7
1981	150,907	88.0	18,243	82.6

**Table 2—Species, period, and number of prefectures in which fish are reared for seed production of commercially important species.**

Species	No. of pref.	Month														
		Jan	Feb	Mar	Apr	May	Jun	Jul	Aug	Sep	Oct	Nov	Dec			
Red sea bream, <i>Pagrus major</i>	15			*	—	—	—	—	—	—	—	—	*			
Black sea bream, <i>Acanthopagrus schlegeli</i>	10							*	—	—	—	—	*			
Japanese parrot fish, <i>Oplegnathus fasciatus</i>	7							*	—	—	—	—	*			
Ayu fish, <i>Plecoglossus altivelis</i>	7		*										*	—	—	—
Japanese flounder, <i>Paralichthys olivaceus</i>	13	*	—	—	—	—	—	—	—	—	—	—	*			
Mud dab, <i>Limanda yokohamae</i>	5	*	—	—	*											
Puffer, <i>Takifugu rubripes</i>	10					*	—	—	—	—	—	—	*			
Red grouper, <i>Epinephelus akaara</i>	4												*	—	—	—
Rockfish, <i>Sebastes schlegeli</i>	2				*	—	—	—	—	—	—	—	*			
Marbled rockfish, <i>Sebastes marmoratus</i>	5					*	—	—	*							
Japanese sea bass, <i>Lateolabrax japonicus</i>	2		*	—	*											
Rabbit fish, <i>Siganus fuscescens</i>	2					*	—	—	—	—	—	—	*			
Yellowfin bream, <i>Acanthopagrus latus</i>	1	—	*												*	—
Yellowtail, <i>Seriola aureovittata</i>	1							*	—	*						
Yellowtail, <i>Seriola quinqueradiata</i>	1							*	—	*						
Lumpfish, <i>Inimicus japonicus</i>	2									*	—	*				
Japanese whiting, <i>Sillago japonicus</i>	1											*	—	*		
Chicken grunt, <i>Parapristipoma trilineatum</i>	1											*	—	*		
Green snapper, <i>Lethrinus nebulosus</i>	1				*	—	—	—	—	—	—	—	*			

**Table 3—Number of young fish ( $\times 10^4$ ) by size produced in 18 prefectures of southern Japan, 1982.**

Species	Size ranges (cm)					Total
	1-2	2-4	4-6	6-8	8-10	
Red sea bream	330	849	413	329	9	1,930
Black sea bream	490	39	47		6	582
Japanese parrot fish	10	64	4	10	10	98
Ayu fish			452			452
Japanese flounder	10	427	164	5		606
Mud dab	105	5				110
Puffer		168	25	510	225	1,631
Red grouper						
Rockfish	2	4	8			14
Marbled rockfish		10	2			12
Japanese sea bass		12				12
Rabbit fish			10			10
Yellowfin bream	1					1
Yellowtail					1	1
Yellowtail		5				5
Lumpfish						
Japanese whiting						
Chicken grunt						
Green snapper						

Blanks indicate <10,000 fish. Refer to Table 2 for latin names of fishes.

In southern Japan, almost 20 million young red sea bream are reared for releasing and for cage culture (Table 3). Red sea bream culture seems to be gradually replacing yellowtail culture in cages, at least during the past several years. This trend is closely related to the successful artificial rearing of the red sea bream to stocking size. Yellowtail culture still depends on catching wild young fish for stocking.

Seed production is already progressing towards commercialization for black sea bream, Japanese parrot fish, and Japanese flounder among fisheries farmers. Other species are still cultivated on an experimental scale. It is hoped that rearing techniques will develop which will result in improved survival of the juvenile stages. Successful rearing of yellowtail fry from eggs, which were spawned spontaneously, provides some hope that the supply of seed fish for net cage culture might be possible in the future, and would decrease the fishing pressure on wild stocks from which young fish are presently caught.

## REFERENCES

STATISTICS AND INFORMATION DEPARTMENT, [JAPAN] MINISTRY OF AGRICULTURE, FORESTRY AND FISHERIES.  
 1983. Fisheries statistics of Japan, 1981.  
 1983. Annual report of statistics in fisheries and aquaculture, 1981.  
 [JAPAN] MINISTRY OF AGRICULTURE, FORESTRY AND FISHERIES.  
 1983. Annual report on Japan's fisheries, fiscal year 1982, a summary.



# Maturation of Kuruma Prawns *Penaeus japonicus* Cultured in Earthen Ponds

ISAO YANO

National Research Institute of Aquaculture, Fisheries Agency,  
Nakatsuhama, Nansei-cho, Mie, Japan

## INTRODUCTION

In decapod crustaceans, control of the reproduction of animals of commercial interest is a major problem for programming their culture. Reproductive maturation in captivity could provide a reliable year-round supply of juveniles, serve in developing selective breeding programs, and be of general usefulness for obtaining disease-free spawners. Several species of penaeid shrimp have been matured and spawned in captivity using unilateral eyestalk ablation or temperature, photoperiod and diet controls (Johnson and Fielding 1956; Idyll 1971; Caillouet 1973; Arnstein and Beard 1975; Duronslet et al. 1975; Laubier-Bonichon and Laubier 1976; Santiago 1977; Halder 1978; Laubier-Bonichon 1978; Primavera 1978; Brown et al. 1979; Lawrence et al. 1979; Lumare 1979; Kelemec and Smith 1980; Chamberlain and Lawrence 1981). Successful maturation of *Penaeus setiferus* and *P. merguinesis* in ponds has been reported by Conte et al. (1977) and Lichatowich et al. (1978), respectively. In Japan, *P. japonicus* is cultured mainly in earthen ponds using postlarvae which have been reared in indoor tanks. Since all prawns are harvested within a 1-year period, the maturation of *P. japonicus* in ponds has not yet been established. The purpose of this research was to determine whether *P. japonicus* could mature under pond culture conditions.

## MATERIALS AND METHODS

A sample of 1,774 (795 females, 979 males) 5-month-old hatchery-reared Kuruma prawns (*Penaeus japonicus*) was obtained from the Hakatajima Prawn Farm. The wet weight of the specimens was 13-22 g in September 1980. No ovarian development was observed in female prawns at this time.

In September 1980 all prawns were released into a 0.7 ha pond located on the grounds of the Momoshima Center of the Japanese Sea Farming Association (Hiroshima Prefecture) (Fig. 1). Mean

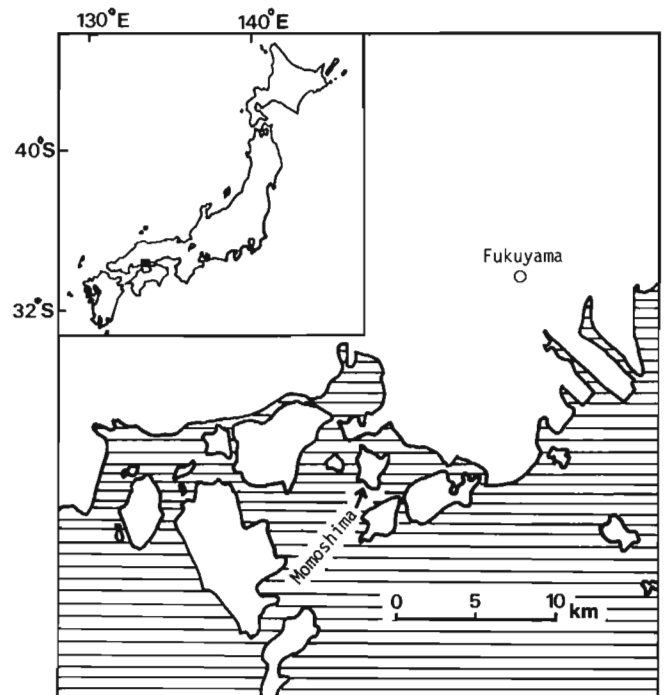

Figure 1—Location of the experimental pond, Momoshima, Hiroshima Prefecture, Japan.

water depth in the pond was 1.5 m (0.5-2.0 m). A water gate installed in the pond was used to enhance tidal water exchange. Predatory fish were kept out by means of a screened fence. Pelleted diets were fed once daily at sunset.

Ovarian development was examined monthly from September 1980 to 1981 on females sampled randomly from the pond. Data were collected on total body weight, body length, gonad weight, and signs of mating (stopper in the yolk). Gonadosomatic indices (GSI) were determined from these data. For histological observation, small pieces from the middle area of the ovary were removed and fixed in Bouin's solution. The fixed ovary pieces were dehydrated in ethanol, embedded in a paraffin-celloidin mixture, sectioned (6  $\mu$ m), and stained in Delafield hematoxylin plus eosin. Fifty to sixty oocytes per ovary were measured for diameter. The development of oocytes was classified into eleven stages according to morphological characters, namely 1) synapsis stage; 2) chromatin nucleolus stage; 3) early perinucleolus stage; 4) late perinucleolus stage; 5) oil globule stage I; 6) oil globule stage II; 7) yolkless stage; 8) primary yolk granule stage; 9) secondary yolk granule stage; 10) pre-maturation stage; and 11) maturation stage. Degree of ovarian maturation was recorded for each sample.

Spawning and hatching were carried out in 0.5 ton fiber reinforced plastic tanks filled with filtered sea water (50  $\mu$ m). Water temperature was maintained at 3-6°C above that of the pond in order to induce spawning. Eighteen ripe females were selected and each placed in individual spawning tanks. Spawning and hatching rates were determined by means of egg and nauplii density counts.

## RESULTS

### Growth of prawns

Rapid growth was observed between May and September while water temperatures remained above 18°C. Mean weight of female prawns was 36.6 g during October 1980, with a final mean weight of 79.0 g recorded in September 1981. Body length increased from 113.9 to 191.0 mm between September 1980 and 1981 (Fig. 2).

Mating rate was 2.8% in September, increasing to 100% in December 1980 (Fig. 3). A high percentage (88-100%) of mated females continued to be observed through September 1981 with the exception of May (20%).

### Changes in gonadosomatic index

Gonadosomatic index (GSI) peaks occurred in late spring-early autumn 1981. The GSI of females increased from 0.4% to 1.5% between September 1980 and April 1981. Some females reached a 10% GSI between May and September 1981 (Fig. 4).

### Development of oocytes

In September 1980 the ovaries contained immature or immature-developing oocytes such as synapsis stage, chromatin nucleolus stage, early perinucleolus stage, and late perinucleolus stage. Oogonia were found throughout the experiment. Oil globule stage I or oil globule stage II oocytes, which are the early developing stages, were observed in early April 1981. In mid to late April and early May 1981, yolkless stage, primary yolk granule stage, and

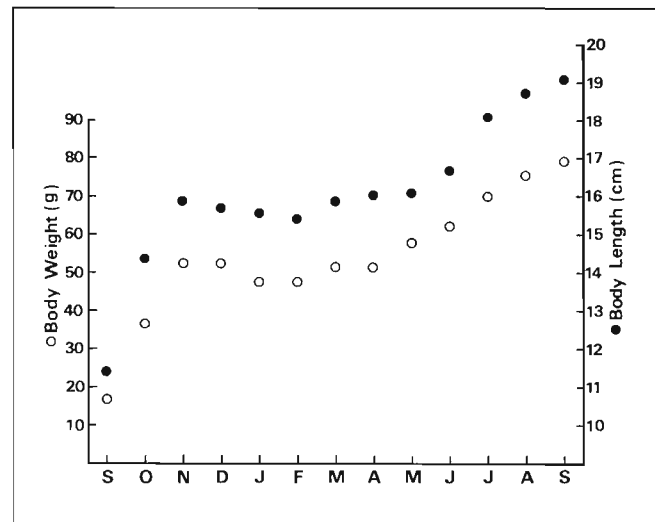

Figure 2—Body weight and body length of *P. japonicus* cultured in an earthen pond, September 1980-1981.

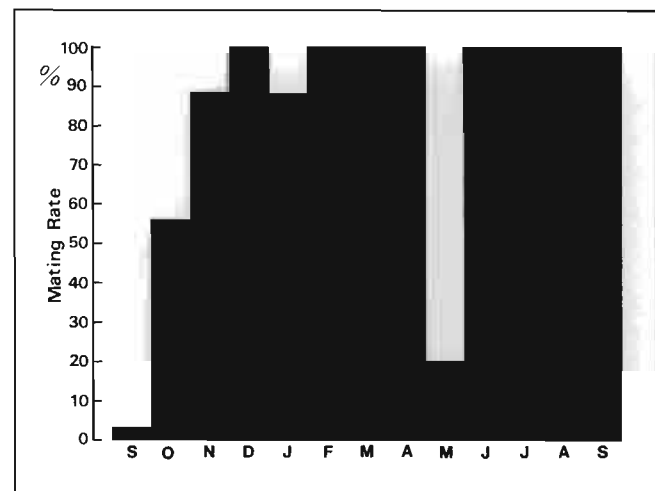

Figure 3—Mating rate of *P. japonicus* cultured in an earthen pond, September 1980-1981.

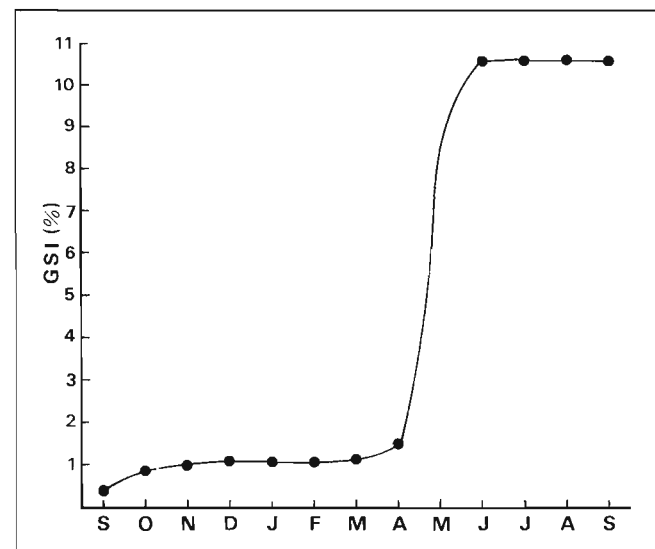

Figure 4—Gonadosomatic index (GSI) of *P. japonicus* cultured in an earthen pond, September 1980-1981.

secondary yolk granule stage oocytes were observed in the developing ovaries. From May to September some oocytes reached the prematuration and maturation stages. The ripe eggs at the maturation stage have many club-shaped cortical rods in the peripheral cytoplasm and contain extensive accumulations of yolk granules dispersed throughout the cytoplasm (Fig. 5). The cytoplasmic membrane and the cortical rods of the oocytes were found to be separated from the external media by a thin egg membrane (0.1  $\mu\text{m}$  thick) that surrounds the egg. Meiotic reduction division of the oocytes was observed to reach only the metaphase of the primary maturation division. Therefore, polar bodies were not observed in the ovarian oocytes.

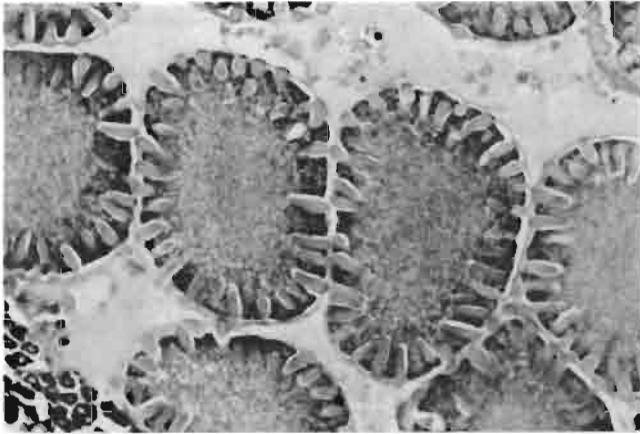

Figure 5—Ripe eggs (maturation stage oocytes) of *P. japonicus* showing the appearance of many club-shaped cortical rods in the peripheral cytoplasm. H & E stain.  $\times 200$ .

### Variation of oocyte size

There was a rapid increase in the sizes of the oocytes from the oil globule stage I to maturation stage, but immature oocytes (synapsis stage, chromatin nucleolus stage, early perinucleolus stage, and late perinucleolus stage) exhibited only a gradual size increase (Table 1). Ripe eggs at the maturation stage measured 250  $\mu\text{m}$  in diameter on the average.

Developmental stage	Oocyte diameter ( $\mu\text{m}$ )
Synapsis stage	10
Chromatin nucleolus stage	16-34
Early perinucleolus stage	30-80
Late perinucleolus stage	68-88
Oil globule stage I	80-160
Oil globule stage II	88-144
Yolkless stage	110-146
Primary yolk granule stage	128-160
Secondary yolk granule stage	136-237
Prematuration stage	200-264
Maturation stage	224-288

### Seasonality of reproductive maturation

Four stages of reproductive maturation were determined as follows:

**Stage I: immature**—The ovaries are extremely thin, translucent, and white. Synapsis, chromatin nucleolus and early perinucleolus stage oocytes are found. Multiplication of oocytes is characteristic of this stage.

**Stage II: immature-developing**—Ovaries are slightly thicker than the previous stage. Fresh ovaries are translucent, light orange colored and smoothly textured. Late perinucleolus stage oocytes appear. This stage is characterized by the appearance of follicular cells on the surface of the oocytes.

**Stage III: developing**—The ovaries are turgid opaque and light green. Oil globule stage I and II, yolkless, primary and secondary yolk granule stages are observed. This stage is characterized by the synthesis of vitellogenin and accumulation of yolk (Yano, unpubl.).

**Stage IV: ripe**—The ovaries are very turgid, broad, opaque and dark green. The outline of the ovary is distinct and the appearance is granular. This stage is characterized by the migration of the nucleus, ovulation and maturation division of the oocytes.

Stages I and II were observed in all samples in autumn and winter 1980. A small percentage of stage III females was first observed in early April 1981. Stage IV females first appeared in mid May and continued through September 1981 (Fig. 6). Spawning was suspected in the pond since stage II females were sampled in August 1981. However, no larvae were found in the pond after plankton tows.

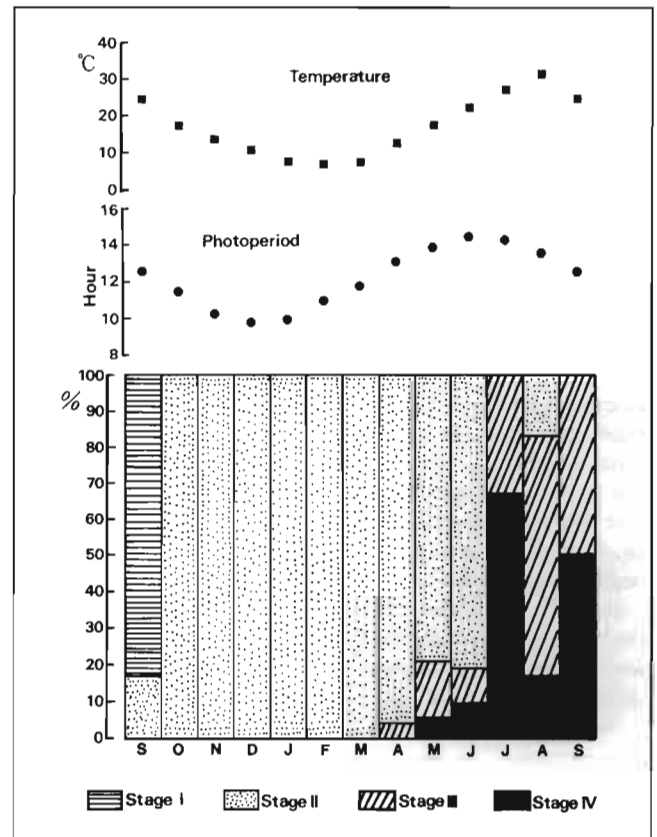

Figure 6—Interaction of temperature, photoperiod, and reproductive maturation in *P. japonicus* cultured in an earthen pond, September 1980-1981.

## Spawning and hatching rates

Seven females of the group of eighteen spawned, resulting in a spawning rate of 39%. Hatching rates of two females were 78.9% (380,000 eggs) and 81.6% (500,000 eggs). The hatching rates for the other five females ranged between 0 and 80.9% (Table 2).

## DISCUSSION

It is clear from the results that Kuruma prawns can be successfully matured under pond culture conditions. Increased ovarian development (spring 1981) and rapid maturation (summer and autumn 1981) were observed as water temperatures increased above 18°C. The change from 12 to 13 hours of daylight in April was also observed to accelerate the ovarian maturation rate. These facts indicate that reproductive maturation is triggered by rising water temperature and increased photoperiod in the spring. Undeveloped ovaries in autumn 1980 (compared to the rapid somatic growth of this period) suggest that sexual maturation may not come about by falling water temperature and reduced photoperiod. It is thought, therefore, that winter temperature inhibits somatic growth and ovarian development, either directly or indirectly by limiting food intake and availability. Optimal maturation temperature for Kuruma prawns is about 25°C. This is indicated by the fact that at 32°C (August) and 18°C (May) rapid ovarian maturation was not observed.

The role of the male prawns in the pond is essential since female prawns are stimulated to molt during periods of high water temperature. Male spermatophores are shed during molting, thus new mating for fertilization is required.

Yatsuyanagi and Maekawa (1955) observed the ovarian maturation of wild Kuruma prawns sampled from the Inland Sea near the area of this experiment. Results indicated that Kuruma prawns cultured in ponds matured earlier (April) than those growing at sea. Minimum size at maturity in the pond was also slightly larger (159 mm in body length) than that of wild females (135-140 mm in body length) (Yatsuyanagi and Maekawa 1955; Kajiyama 1933).

Nothing has been known of the correlation between mating and ovarian maturation in *P. japonicus*. Results suggest that mating does not directly accelerate ovarian maturation of Kuruma prawns, since ovarian maturation was observed in spring after mating had occurred in autumn of the previous year.

The period of time required for maturation following the appearance of the oil globule stage I oocytes may be as short as 2 months. Oocytes at this stage may be used as a maturation indicator, since vitellogenin (egg yolk precursor) can be first observed in the blood serum at this time (Yano, unpubl.). Oocyte diameter (>100 µm) can also be used as an indicator of the first stages of vitellogenesis. The potential of Kuruma prawns for multiple spawnings during a single spawning season can be demonstrated by the presence of oögonia in the ovary at all times.

Kuruma prawns were not observed to spawn in the pond. However, when ripe females were thermally stimulated under laboratory conditions, spawning was achieved. This indicates that thermal stimulation is necessary to induce spawning.

The spawning (39%) and hatching (80%) rates observed during the experiment compare favorably with those of wild females (Yamaguchi Prefecture 1961). Hatchery techniques may be improved upon in order to achieve better results. With successful reproductive maturation and spawning of Kuruma prawns under pond culture conditions, new perspectives for the aquaculture industry will surely arise.

Table 2—Spawning record of Kuruma prawn (*Penaeus japonicus*) cultured in an earthen pond in 1981.

Spawner no.	Date	Body length (cm)	Total no. eggs	Total no. nauplii	Hatching rate (%)
1	30 May	18.2	130,000	11,000	8.5
2	11 June	18.6	68,000	55,000	80.9
3	25 June	16.6	380,000	300,000	78.9
4	26 June	17.3	410,000	60,000	14.6
5	15 July	16.7	405,000	0	0.0
6	25 July	18.7	480,000	72,000	15.0
7	25 July	18.5	500,000	408,000	81.6

## ACKNOWLEDGMENT

This work was supported in part by a research grant from the Japanese Sea Farming Association.

## CITATIONS

- ARNSTEIN, D. R., and T. W. BEARD.  
1975. Induced maturation of the prawn *Penaeus orientalis* Kishinouye in the laboratory by means of eyestalk removal. *Aquaculture* 5:411-412.
- BROWN, A., J. MCVEY, B. S. MIDDLEDITCH, and A. L. LAWRENCE.  
1979. Maturation of white shrimp (*Penaeus setiferus*) in captivity. *Proc. World Maricult. Soc.* 10:435-444.
- CAILLOUET, C. W.  
1973. Ovarian maturation by eyestalk ablation in pink shrimp *Penaeus duorarum* Burkenroad. *Proc. World Maricult. Soc.* 3:205-225.
- CHAMBERLAIN, G. W., and A. L. LAWRENCE.  
1981. Maturation, reproduction, and growth of *Penaeus vannamei* and *P. stylirostris* fed natural diets. *Proc. World Maricult. Soc.* 12:209-224.
- CONTE, F. S., M. S. DURONSLET, W. H. CLARK, and J. C. PARKER.  
1977. Maturation of *Penaeus stylirostris* (Stimpson) and *P. setiferus* (Linn.) in hypersaline water near Corpus Christi, Texas. *Proc. World Maricult. Soc.* 8:327-334.
- DURONSLET, M. J., A. I. YUDIN, R. S. WHEELER, and W. H. CLARK.  
1975. Light and fine structural studies of natural and artificially induced egg growth of penaeid shrimp. *Proc. World Maricult. Soc.* 6:105-122.
- HALDER, D. D.  
1978. Induced maturation and breeding of *Penaeus monodon* Fabricius under brackish water pond conditions by eyestalk ablation. *Aquaculture* 15:171-174.
- IDYLL, C. P.  
1971. Induced maturation of ovaries and ova in pink shrimp. *Commer. Fish. Rev.* 33:20.
- JOHNSON, M. C., and J. R. FIELDING.  
1956. Propagation of the white shrimp, *Penaeus setiferus* (Linn.), in captivity. *Tulane Stud. Zool.* 4:175-190.
- KAJIYAMA, E.  
1933. Spawning and growth of *P. japonicus*. *Annu. Rep. Hiroshima Prefect. Fish. Exp. Stn.* 12:134-159.
- KEI.EMEC, J. A., and I. R. SMITH.  
1980. Induced ovarian development and spawning of *Penaeus plebejus* in a recirculating laboratory tank after unilateral eyestalk enucleation. *Aquaculture* 21:55-62.
- LAUBIER-BONICHON, A., and L. LAUBIER.  
1976. Reproduction contrôlée chez la crevette *Penaeus japonicus*. *FAO Tech. Conf. Aquacult., Kyoto, Japan, 26 May-2 June 1976.*
- LAUBIER-BONICHON, A.  
1978. Ecophysiologie de la reproduction chez la crevette *Penaeus japonicus*. *Trois années d'expérience en milieu contrôlé. Oceanol. Acta.* 1:135-157.
- LAWRENCE, A. L., D. WARD, S. MISSLER, A. BROWN, J. MCVEY, and B. S. MIDDLEDITCH.  
1979. Organ indices and biochemical levels of ova from penaeid shrimp maintained in captivity versus those captured in the wild. *Proc. World Maricult. Soc.* 10:453-463.
- LICHATOWICH, T., T. SMALLEY, and F. D. MATE.  
1978. The natural reproduction of *Penaeus merguensis* (DE MAN, 1888) in an earthen pond in Fiji. *Aquaculture* 15:377-378.

- LUMARE, F.  
1979. Reproduction of *Penaeus kerathurus* using eyestalk ablation. *Aquaculture* 18:203-214.
- PRIMAVERA, J. H.  
1978. Induced maturation and spawning in five-month-old *Penaeus monodon* Fabricius by eyestalk ablation. *Aquaculture* 13:355-359.
- SANTIAGO, A. C.  
1977. Successful spawning of cultured *Penaeus monodon* Fabricius after eyestalk ablation. *Aquaculture* 11:185-196.
- YAMAGUCHI PREFECTURE.  
1961. Seed production of *Penaeus japonicus*. Annu. Rep. Yamaguchi Prefect. Inland Sea Fish. Exp. Stn. 11:354-385.
- YATSUYANAGI, K., and K. MAEKAWA.  
1955. The ecology of *Penaeus japonicus* in Inland Sea. Annu. Rep. Yamaguchi Prefect. Inland Sea Fish. Exp. Stn. 7:1-15.



# Cultivation and Seedling Production of Brown Algae in Japan

YOSHIAKI SANBONSUGA

Hokkaido Regional Fisheries Research Laboratory  
Fisheries Agency, Kushiro,  
Hokkaido 085, Japan

## ABSTRACT

This report briefly outlines the current brown algal cultivation and seedling production method used in Japan. Since the 19th Century, many cultivation efforts such as placing stones in the sea and weeding out competing seaweeds have been made to maintain and increase the brown algal resources, with the support of the National Government. Another method used for the cultivation of brown algae is called "suspended cultivation" or "raft cultivation". Raft cultivation of *Undaria* started in the early 1960's, and is the main method practiced at present. The amount of *Laminaria* production through raft cultivation has also increased markedly during the past ten years. The value of this crop is about 30% of that of the wild harvest at present. In 1980, the total amount of seedling strings produced was 2,192 and 883 km for *Undaria* and *Laminaria*, respectively.

## INTRODUCTION

---

The Japanese archipelago extends over a long distance from north to south, and is influenced by both the warm Kuroshio Current and the cold Oyashio Current. For these geographic and oceanographic reasons, as many as 860 species of seaweeds grow in Japanese waters (Okamura 1932), many having been harvested and used as human food and fertilizer since ancient times (Miyashita 1974) and as industrial materials, providing agar, alginic acid, potassium and iodine (Okazaki 1971).

Japanese fisheries statistics for 1980 report that about 183,000 tons (fresh weight) of wild seaweed were harvested, mainly for human food. Total value of the crop was estimated at 41 billion yen (\$170 million). Brown algae, mainly *Laminaria* and *Undaria*, account for approximately 78% of the total harvest. Cultivated algae were not taken into account in these figures. Many fishermen have long obtained their livelihood from the harvest of wild seaweeds in Japan.

Large brown algae are also economically important because they serve as food for useful shellfish such as the abalone and sea urchin, and they also provide spawning grounds and shelter for many juvenile fish. Therefore, brown algae are both directly and indirectly important for fishermen. For this reason, fishermen have attempted to maintain and increase the brown algae resources, with the support of the Japanese government.

## CULTIVATION OF BROWN ALGAE

---

### *Laminaria*

Among the brown algae, *Laminaria* is the favorite edible seaweed in Japan. Much like the red alga *Porphyra*, it is used both as food and for seasoning. *Laminaria* is called "Kombu" in Japanese, the word meaning "delight". It is served for happy events such as betrothals, and used as a New Year's decoration. *Laminaria* is indispensable to the Japanese people. Its annual yield amounts to about 125,000 tons in fresh weight and, as indicated above, has a value in excess of 30 billion yen (\$100 million). The commercially important species of *Laminaria* are *L. japonica* Areschoug, *L. japonica* var. *ochotensis* Okamura, *L. diabolica* Miyabe, *L. angustata* Kjellman, and *L. angustata* var. *longissima* Okamura.

All of the species and varieties are harvested from Hokkaido and northern Honshu, where many fishermen depend on the harvest for their livelihood. Thus efforts are made, such as placing stones in the sea, to provide new substrates for the settlement of *Laminaria* spores. Efforts are also made to remove competing seaweeds. This work is supported with financial aid from the National Government.

Another method used for the artificial cultivation of *Laminaria* in Japan is called "suspended cultivation" or "long-line cultivation." Since *Laminaria* plants are harvested when they reach an age of about two years, they have to be grown through two winters. Thus the culture raft and other culturing equipment has to be solid and firmly anchored. This means that in Japan, the cultivation of *Laminaria* is economically unrewarding. However, through development of the "forced cultivation" technique, one-year-old *Laminaria* plants can be produced that have the characteristics and quality of two-year-old plants (Hasegawa 1971). Because of this advance, the amount of commercial *Laminaria* production through raft cultivation has increased markedly for the past ten years in the southern part of Hokkaido and northern Honshu (Table 1). At present, raft cultivation is also practiced in the middle and southern

Table 1—Quality and value of *Laminaria* production by long-line cultivation, 1970-80.

Year	1970	1971	1972	1973	1974	1975	1976	1977	1978	1979	1980
quality (metric tons)	284	665	3,340	7,681	10,201	15,759	22,096	27,260	21,890	25,291	38,561
value (million yen)	53	95	481	1,589	1,868	2,365	3,877	3,736	3,336	5,111	8,984

regions of Japan, where *Laminaria* have never grown naturally. In 1980, the amount of cultivated *Laminaria* was about 39,000 tons in fresh weight, and is valued at about 30% of that of the wild harvest from natural reefs.

Brown algae are major constituents of the natural sublittoral flora in Japan. The predominating genera are *Alaria*, *Laminaria*, and *Costaria* in the northern part of Japan, and *Eisenia* and *Ecklonia* in the middle and southern parts of Japan. As mentioned earlier, these brown algae are important sources of food for useful sea animals such as the abalone and sea urchins. For this reason, the Japanese government program of "coastal fishing ground improvement and development" involves the artificial propagation of large brown algae. In order to increase food supply and favorable conditions for sea animals, the economic efficiency of suspended raft cultivation of *Laminaria* has been studied recently in Japan.

### *Undaria*

*Undaria*, which like *Laminaria* is one of the most important edible seaweeds in Japan, is harvested all along the Japanese coast except in the cold regions around Hokkaido and in warm regions such as Okinawa. Raft cultivation of *Undaria* started in the early 1960's in northern Honshu and spread to other suitable growing regions in Japan over the past 20 years. At present, *Undaria* is produced mainly by raft culture. In 1980 the production of cultivated *Undaria* was estimated to be approximately 114,000 tons fresh weight. The value of this crop is more than seven times that of the harvest of wild plants from natural reefs.

The commercial cultivation of another edible brown alga, *Cladostiphon*, has recently started. This plant is grown in warm water regions such as Okinawa. The 1980 production was about 3,000 tons fresh weight.

### SEEDLING PRODUCTION OF BROWN ALGAE

Since all of the above mentioned large brown algae belong to the order of Laminariales, their life history pattern is identical. The life history of all laminarialian plants consists of a macroscopic sporophytic stage and a microscopic gametophytic stage. The sporophyte produces spores which germinate and grow to form microscopic dioecious gametophytes. The female gametophyte produces eggs, and the male produces antherizoids. After fertilization, the eggs form zygotes that develop into juvenile sporophytes, which in turn grow into large plants (Fig. 1). In the cultivation of laminarialian plants, "seedling production" refers to the collection of spores and rearing them through the gametophytic phase to the point where juvenile sporophytes are produced. Mass seedling production is initiated by collecting fruiting sporophytic plants. Special "Kuremona" string is soaked in a dense suspension of spores obtained from the

fruiting plants. *Laminaria* spores that settle on the strings are grown indoors for one or two months. Settled *Undaria* spores are directly transferred to the sea. It is possible for an individual fisherman to collect spores and grow *Undaria* seedlings in his own culture tanks. However, for *Laminaria* seedlings it is less costly in most cases to purchase them from a seedling producer, usually a fisheries cooperative which produces large quantities of seedlings. *Undaria* seedlings are produced all along the Japanese coast, but seedlings of *Laminaria* are produced only in Hokkaido and on the north Pacific coast of Honshu, and are supplied from these regions to the southern part of Japan. Japanese fisheries statistics for 1980 report that the total amount of seedling strings produced was 2.192 and 883 km for *Undaria* and *Laminaria*, respectively. Most of the seedlings were used for human food production.

### PROSPECTS FOR THE FUTURE CULTIVATION OF BROWN ALGAE IN JAPAN

I have presented here only a brief outline of the current brown algal cultivation and seedling production methods used in Japan. Suspended cultivation of seaweeds on longline rafts is very efficient when compared with the propagation on, and harvest of, plants from reefs. Therefore, it is likely that the future cultivation of seaweeds will be mainly through suspended cultivation, even though *Laminaria* is propagated and harvested on reefs at present. The consumption of brown algae such as *Laminaria* and *Undaria* as human foods is limited and will probably not increase markedly in Japan. Thus the mass cultivation of these seaweeds will provide crops that can be used for other purposes. The artificial propagation of abalone and sea urchins in Japan is now being studied, and the production of seaweeds as food for these animals is being seriously considered. This is important because the natural stands of seaweeds along the coast are insufficient to support large numbers of grazing animals. Thus it is likely that there will be a major effort made to produce brown algae such as *Laminaria*, *Costaria*, *Undaria*, *Eisenia*, and *Ecklonia* for sea animal food. If this is successful, it will make it possible to increase the production of abalone and sea urchins in the near future.

As noted earlier, the Japanese government has begun to encourage technical innovation in the mass cultivation and utilization of seaweeds. Similar programs are now in progress in the United States, where the cultivation of large brown algae also holds the prospect for producing resources from the sea. However, there are still many unsolved problems. Consequently, I think that it is very desirable for us to have opportunities to exchange opinions and knowledge with research workers in other countries, especially the United States.



# CITATIONS

- HASEGAWA, Y.  
1971. Forced cultivation of *Laminaria*. Proc. 7th Seaweed Symp., p. 391-393.
- MIYASHITA, A.  
1974. Seaweeds. Hosei Univ. Press, Tokyo (In Jpn), 315 p.
- OKAMURA, K.  
1932. The distribution of marine algae in Pacific waters. Rec. Oceanogr. Works  
Jpn 4(1):31-150.
- OKAZAKI, A.  
1971. Seaweeds and their uses in Japan. Tokai Univ. Press, Tokyo, 165 p.

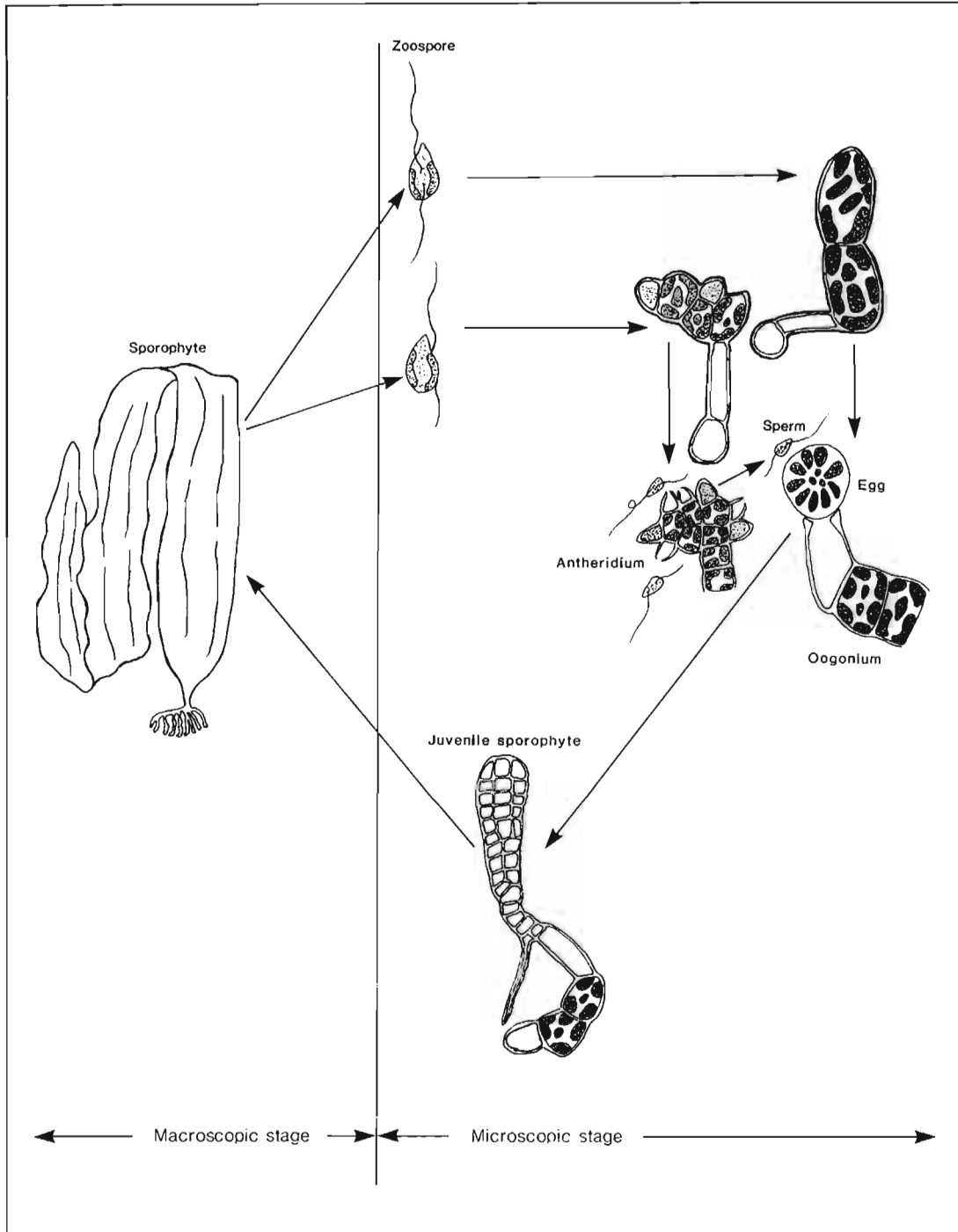

Figure 1—Life history of *Laminaria*.



# Seed Production of Red Sea Bream *Pagrus major* (Sparidae) in Japan

OSAMU FUKUHARA

Nansei Regional Fisheries Research Laboratory  
Ohno-cho, Saeki-gun, Hiroshima 739-04, Japan

## INTRODUCTION

During the past decade extended research efforts have been directed towards an improvement in rearing techniques for early life history stages of marine fishes. The development of mass rearing methods has already played an active role in the history of marine aquaculture in Japan. The drastically increasing demand for aquaculture products has recently been accelerated by the establishment of the 200-mile economic zone. As a consequence, governmental programs are concentrating on the improvement and development of coastal fishing grounds, including mass releasing programs for important local species. Under these circumstances, it was decided to continue the construction of Fish Farming Centers at strategically important points along the coast line of Japan (Fig. 1).

Each of the Farming Centers produces large quantities of small fish, prawns, and molluscs in order to release them into the natural environment, thereby supporting the recruitment of exploited stocks. Furthermore, experiments are under way to explore the most effective methods to utilize the adult fish. Among the major species produced at the Farming Centers, red sea bream (*Pagrus major*) is one of the most important and popular species, both in the northern and southern areas.

This paper describes the present status of artificial propagation of *Pagrus major* in Japan and outlines specifically the rearing techniques employed in governmental Farming Centers and in private hatcheries.

Egg collection in the past depended largely on weather conditions and availability of parental fish from wild stocks, proper sex ratio in captivity, maturity stage, and egg numbers spawned per female. Therefore, treatment procedures using hormone injection have been employed to obtain viable eggs. However, egg production could not be stabilized in the initial phase of the work. After natural spawning succeeded in captivity (Noguchi 1968), viable eggs were collected mainly and more regularly from brood stocks maintained in the tanks. Artificial breeding has advanced since then by

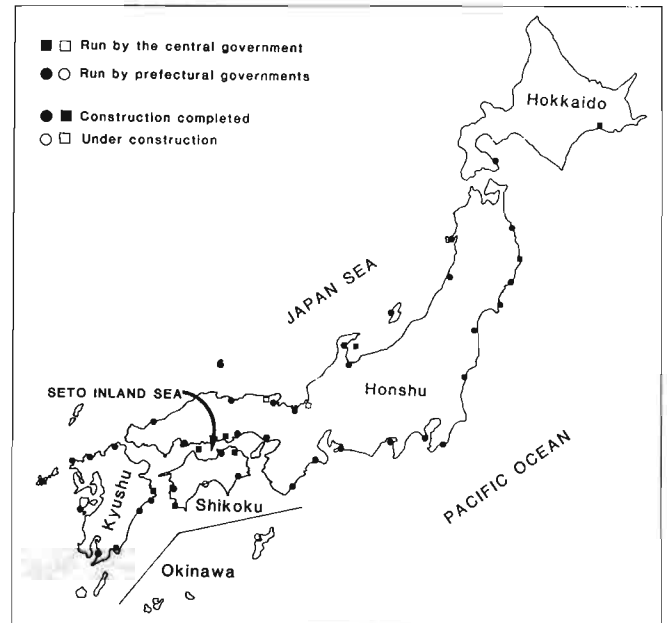

Figure 1—Location of governmental and prefectural Fish Farming Centers (modified from Annual Report on Japanese Fisheries, Ministry of Agriculture, Forestry and Fisheries).

establishing techniques that allow natural spawning and mass production of suitable organisms at the same time (Fukuhara 1975).

Seasonal activities for artificial propagation are outlined in Figure 2. All procedures indicated vary slightly in technical detail, depending on the facilities and strategies employed at each location.

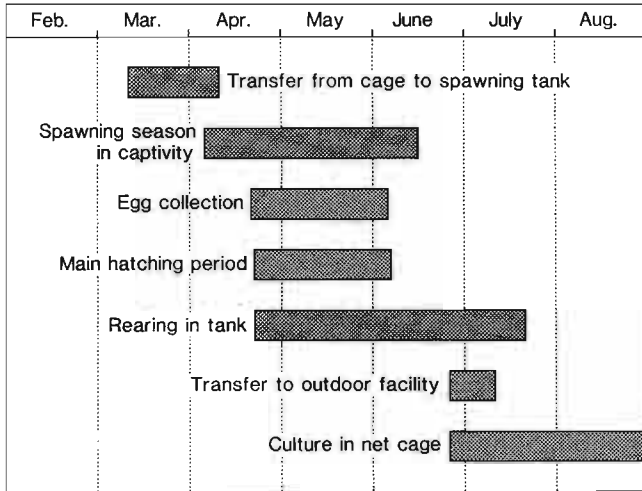

Figure 2—Distribution of seasonal activities related to the artificial propagation of red sea bream, *Pagrus major*, in Japanese hatcheries. Time periods for each activity vary according to the spawning.

## CULTURE OF BROOD STOCK

Brood stocks are usually maintained outside during the spawning season in facilities installed in the sea (mainly floating net cages) (Fig. 3). This is done because the maintenance of adult fish is easier and cheaper in the sea than on land. The transport of spawners is generally done about 4 to 6 weeks before the spawning season, from floating net cages to specially prepared spawning tanks of an appropriate size.

Tank volumes of approximately 50 to 100 m<sup>3</sup> water are quite commonly used for spawning tanks, and a 1:1 sex ratio of males and females is used. The age of the spawners varies between 4 and 7 years. They are maintained at a density between 0.7 and 1.5 individuals/m<sup>3</sup>. High stocking densities and uneven sex-ratio of spawners in the spawning tanks cause negative effects on successful spawning (Fushimi 1972). Fresh small fishes (anchovy, sand lance, and mackerel) are the preferred diet prior to and during the spawning season.

The spawning period extends for 50 to 70 days from March to June. The onset of the spawning season occurs earlier in the Pacific region than in the Seto Inland Sea and the Japan Sea (Fig. 4). In some districts the energy from power stations is utilized to induce an early spawning through elevated temperature. Eggs spawned during the initial phase of the spawning season are unsuitable for rearing because of their low quality, resulting in low hatching rates. Eggs spawned during the peak spawning season (late April to late May) are suitable for rearing. Ambient temperatures during the spawning season range from 14° to 23°C. During one spawning season about 100 to 400 × 10<sup>4</sup> eggs are collected from one 3-to-6 year-old female within 50-70 days in captivity.



Figure 3—Floating net cages for cultivation of brood stocks of red sea bream. Cages are usually installed in front of the farming facilities. Parental fish are transferred to spawning tanks on land prior to the spawning season. Cages are covered with fishing net to prevent predation by birds.

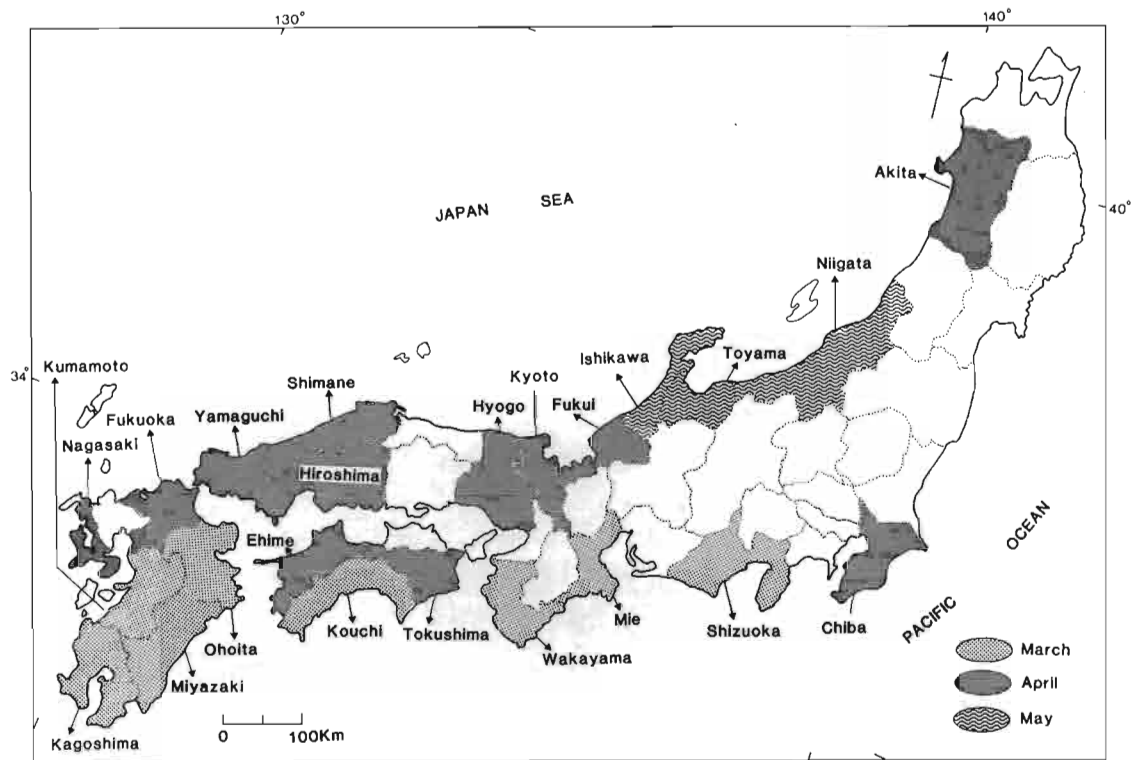

Figure 4—Major spawning season for *Pagrus major* in various prefectures of Japan.

## INCUBATION

Pelagic eggs of *Pagrus major* are collected by filtering the overflow water from the spawning tank with a fine-meshed net. Eggs are transferred daily to an incubation net. There they are kept in a flow-through system until hatching (Fig. 5). Sometimes eggs are introduced directly to rearing tanks at a density of 3000 to 9000 eggs/m<sup>3</sup>, where they hatch without extensive control of their mortality.

## LARVAL REARING

Tank capacity used for larval rearing ranges between 10 and 200 m<sup>3</sup>; the usual average size is 20 to 100 m<sup>3</sup> (Figs. 6, 7). Hatched larvae are maintained at densities of 5,000 to 50,000 individuals/m<sup>3</sup>. Optimum stocking density has been determined experimentally to be 400-5000 individuals/500-L tank volume (Hirata et al. 1975).

The feeding regime for larval rearing is shown in Fig. 8. Unlike the present practice, oyster larvae (*Crassostrea gigas*) were formerly employed as food organisms. The main reason why oyster larvae have been omitted from the list of feeding items is the difficulty in preparing large quantities. Cultured rotifers (*Brachionus plicatilis*) are now fed initially at a density ranging between 5 and 10 individuals/mL in the rearing tank. *Chlorella* species are also introduced to the rearing tanks at concentrations between 30 and 100 cells/mL. This is done during the period of rotifer feeding. The inoculation of *Chlorella* is intended to avoid starvation of rotifers offered as food, thereby maintaining their nutritional quality. Furthermore, they help to reduce the disintegration of faeces. Rotifers are the principal plankton food for the larval stages; subsequently

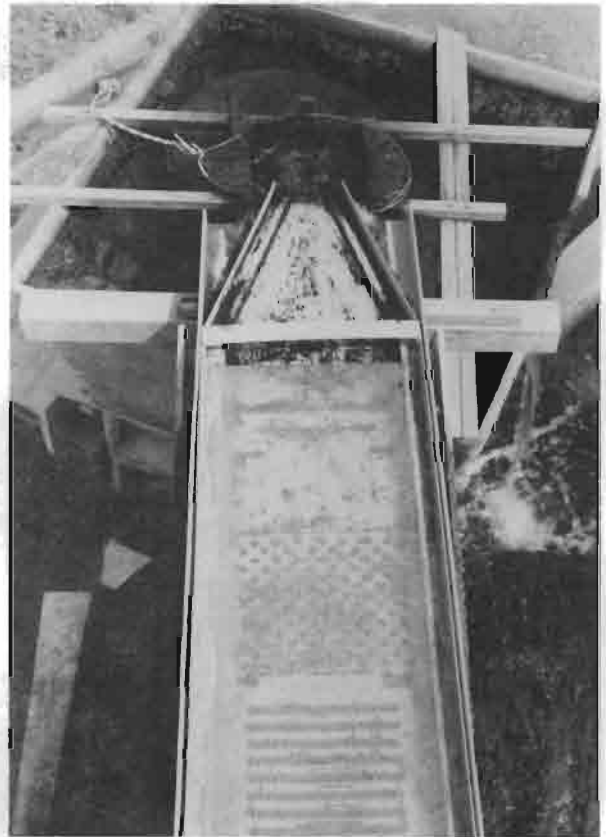

Figure 5—Pelagic eggs of *Pagrus major* are collected from the spawning tank through fine-meshed nets, which are filtering the overflow water. Nets are exchanged every day and eggs transferred to incubation facilities.

*Artemia* nauplii, frozen rotifers, copepods (*Tigriopus japonicus*), and other organisms are fed in addition to rotifers. The larvae are reared in a standing water tank up to an initial period of 2 to 3 weeks.

Thereafter water exchange and regular removal of settled solids from the bottom is undertaken periodically by a siphon. Subsequently, water exchange frequencies are increased with larval growth,

gradually integrating a "flow-through" system. With regard to aeration, a close relationship was found between the volume of air and the aeration intensity and abnormalities in air-bladder and vertebral development (Utsunomiya and Suizu 1980; Kitajima et al. 1981; Iseda 1982). Gentle aeration ranging between 10 and 100 mL/(min·m<sup>3</sup>) is used in the initial rearing.

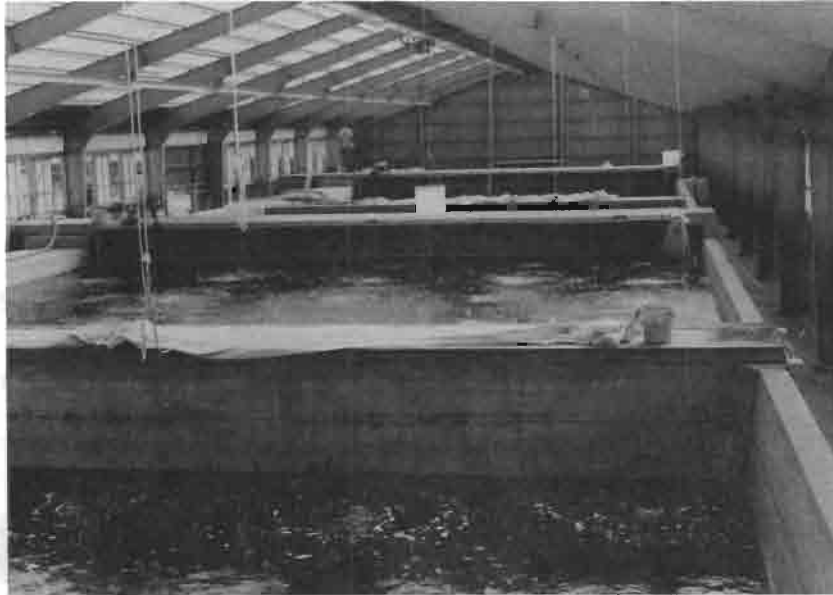

Figure 6—View of indoor tanks employed to rear larval marine fish as well as kuruma prawn; tank volume 200 m<sup>3</sup>.

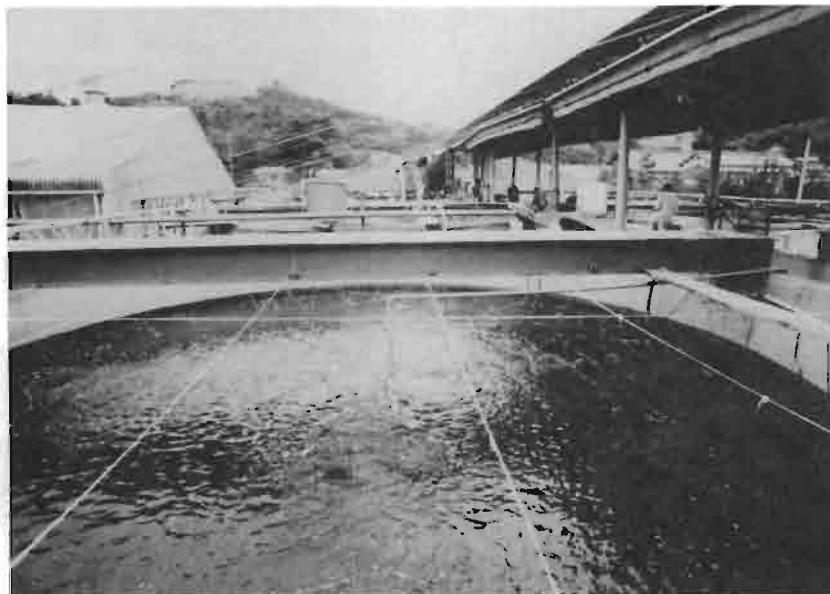

Figure 7—View of outdoor tanks used for initial rearing of larval *Pagrus major*. The facility is suitable for mass production.

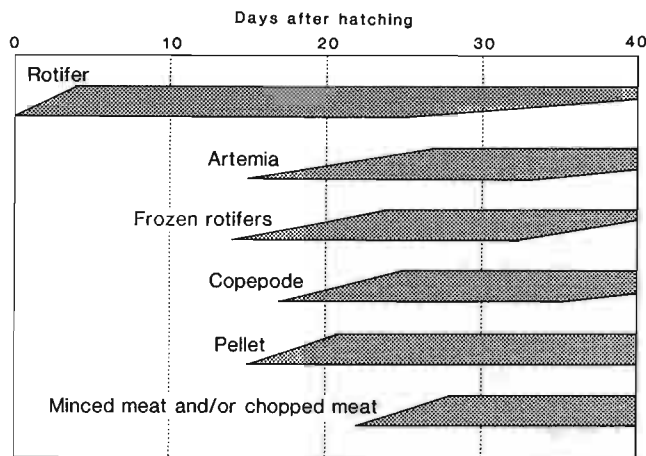

Figure 8—Various food organisms and feeding periods in rearing larval *Pagrus major* in tank or cages. Bars represent earliest (lower line) and latest (upper line) point in time at which food is employed.

## CULTURE IN NET CAGES

The transport of the metamorphosed young fish is carried out after acclimatizing them step-by-step from the rearing facility on land to the conditions in the sea. Usually the rearing period on land is called "initial breeding." The raising of fry in the sea, where they are then used for augmenting natural stocks is called "intermediate culture." The sizes of net cages used during the intermediate culture range from  $3 \times 3 \times 3$  to  $6 \times 6 \times 6$  m. Stocking densities of fry range from 100 to 600 fish/ $m^3$ , depending on mesh-size of the net and the tidal conditions on the farming grounds (Fig. 9). Nets of the cage are changed depending on fish growth and accumulation of fouling organisms such as ascidians, barnacles, mussels, and seaweed and debris on the net surface (Fig. 10).

## CHLORELLA CULTURE

The tank volume used for culturing *Chlorella* varies between 10 and 800  $m^3$ . Tank sizes required for culturing *Chlorella* are 1.5 to 3 times greater than those needed for rotifer cultivation. Initially, agricultural fertilizers are added to the tanks which are filled with sea water of ambient salinity. Fertilization amounts to 70-100 g ammonium sulfate/ $m^3$ , 10-50 g calcium superphosphate/ $m^3$ , and 5-50 g urea/ $m^3$ . Some other ingredients are also added for plankton culture if necessary. Then the *Chlorella* inoculation is introduced into the tank at a concentration of about  $300$  to  $600 \times 10^4$  cells/mL. Tank water is aerated heavily through perforated air pipes and/or air stones. At peak culture bloom of the phytoplankton, cell numbers reach a density of up to  $2500$ - $4000 \times 10^4$  individuals/mL. The maximum temperature for adequate growth of *Chlorella* is  $18^\circ C$ . During the summer season, reproduction of *Chlorella* is often decreased due to high temperatures. In such cases the salinity of the culture medium is reduced by dilution down to values of 10-20%. This is achieved by addition of fresh water. Growth of *Chlorella* can be reactivated by this method at high temperatures. Sodium hypochloride is often used to treat bacteria and Protozoa in the tank during culture. Both batch and continuous cultures are tried in hatcheries. In the case of batch culture, the period is mostly more than 3 weeks.

## ROTIFER CULTURE

During the past decade, culture techniques for rotifers have been improved remarkably; much of the progress can be attributed to the development of adequate feeds, resulting in improved nutrition. Recently, the quality of yeast has been improved by the addition of polyunsaturated fatty acids, especially of the  $\omega$ -3 type (Kitajima et al. 1980; Watanabe et al. 1979). These feeds are useful when cultured *Chlorella* is unavailable, and to save tank capacity. Standard amount of yeast is about 1 g per one million rotifers in culture. *Chlorella* as well as concentrated *Chlorella* are used successfully among culturists and farmers in large-scale culture units. Alcohol fermentation by products have been tried experimentally to culture rotifers (Fukuhara et al. 1982; Higashihara et al. 1983).

When using processed materials as feeds to culture rotifers, natural food in form of *Chlorella* is still provided to the rotifers just before feeding them to the fish larvae (Fig. 11). This short-time exposure of rotifers to algae will enrich and improve the nutritional value of the rotifers (Kitajima et al. 1979). A tank capacity of  $<100 m^3$  is mainly used to culture rotifers (Fig. 12). The density of rotifers at the start of culture varies between 30 and 60 animals/mL. They are harvested for feeding when they exceed a density of 70 to 100 animals/mL.

## PROBLEMS AND PERSPECTIVES FOR FARMING FISHERIES

At the present time, the number of fingerlings of *Pagrus major* produced for releasing or for cage culture may exceed one million annually in one Farming Center or hatchery (Fig. 13). Every procedure, however, in artificial propagation still depends largely on weather conditions and/or biological aspects (availability of eggs and food organisms). Therefore, yield in rearing seedlings fluctuates widely with each trial. To obtain stable production, more multifaceted research is required to provide useful scientific and technical data to optimize rearing practices. Furthermore, the biological quality of produced seeds and its effect on subsequent post-release survival is nearly unknown.

In the past decade most efforts concentrated on increasing the number of fish raised per production unit. It is a prerequisite for a more effective use of the young fish produced, especially for releasing programs, that more information on the differences in the biological characteristics of natural and reared animals should be collected (Fujiya 1974). Some acclimation and familiarization in natural surroundings, or training of the animals produced should be tried to obtain best results in the farming fisheries.

## CITATIONS

- FUJIYA, M.  
1974. Fish farming and the constraints in Japan. In Proceedings of the First U.S.-Japan meeting on aquaculture, Tokyo, Japan, October 18-19, 1971. NOAA Tech. Rep. NMFS CIRC-388, p. 27-32.
- FUKUHARA, O.  
1975. The present status and some unsolved problems on artificial propagations of marine fishes. Spec. publ., of Aquaculture Division, Nansei Reg. Fish. Res. Lab., Hiroshima, Japan. (in Jpn.)
- FUKUHARA, O., H. YUKAWA, and T. NISHIMURA.  
1982. Culture of rotifer, *Brachionus plicatilis* (Müller), in an air lift aquarium using alcohol fermentation slops. Bull. Nansei Reg. Fish. Res. Lab. (14):1-11.
- FUSHIMI, T.  
1972. Studies on egg-taking from cultured red sea bream, *Pagrus major* (Temminck et Schlegel)-III. Tech. Rep. Farm. Fish. 1(1):15-20 (in Jpn.).



HIGASHIHARA, T., S. FUKUOKA, T. ABE, I. MIZUHARA, O. IMADA, and R. HIRANO.

1983. Culture of the rotifer *Brachionus plicatilis* using a microbial flock produced from alcohol fermentation slop. Bull. Jpn. Soc. Sci. Fish. 49(7):1001-1013.

HIRATA, M., T. FUJITA, S. HAMADA, and F. NAGATA.

1975. Studies on mass production of red sea bream. Tech. Rep. Farm. Fish. 4(2):61-68 (in Jpn.).

ISEDA, H.

1982. Prevention of demonstration in the juveniles of red sea bream, *Pagrus major* reared in ponds - III. Bull. Kumamoto Prefect. Fish. Exp. Stn. (2):25-45.

KITAJIMA, C., S. FUJITA, F. OHWA, Y. YONE, and T. WATANABE.

1979. Improvement of dietary value for red sea bream larvae of rotifers *Brachionus plicatilis* cultured with baker's yeast *Saccharomyces cerevisiae*. Bull. Jpn. Soc. Sci. Fish. 45(4):469-471.

KITAGIMA, C., T. ARAKAWA, F. OOWA, S. FUJITA, O. IMADA, T. WATANABE, and Y. YONE.

1980. Dietary value for red sea bream larvae of rotifer *Brachionus plicatilis* cultured with a new type of yeast. Bull. Jpn. Soc. Sci. Fish. 46(1):43-46.

KITAJIMA, C., Y. TSUKASHIMA, S. FUJITA, T. WATANABE, and Y. YONE.

1981. Relationship between uninflated swimbladders and lordotic deformity in hatchery-reared red sea bream *Pagrus major*. Bull. Jpn. Soc. Sci. Fish. 47(10):1289-1294.

NOGUCHI, T.

1968. Natural spawning of red sea bream in an aquarium. Fish Culture 5(3): 81-85 (in Jpn.).

UTSUNOMIYA, T., and H. SUIZU.

1980. Relationship between aeration volume and inflating of the air bladder of larval red sea bream in initial rearing. Rep. Yamaguchi Outsea Farm. Fish. Center (4):9-17 (in Jpn.).

WATANABE, T., F. OOWA, C. KITAJIMA, S. FUJITA, and Y. YONE.

1979. Relationship between the dietary value of rotifers *Brachionus plicatilis* and their content of  $\omega$ 2 highly unsaturated fatty acids. Bull. Jpn. Soc. Sci. Fish. 45(7):883-890.

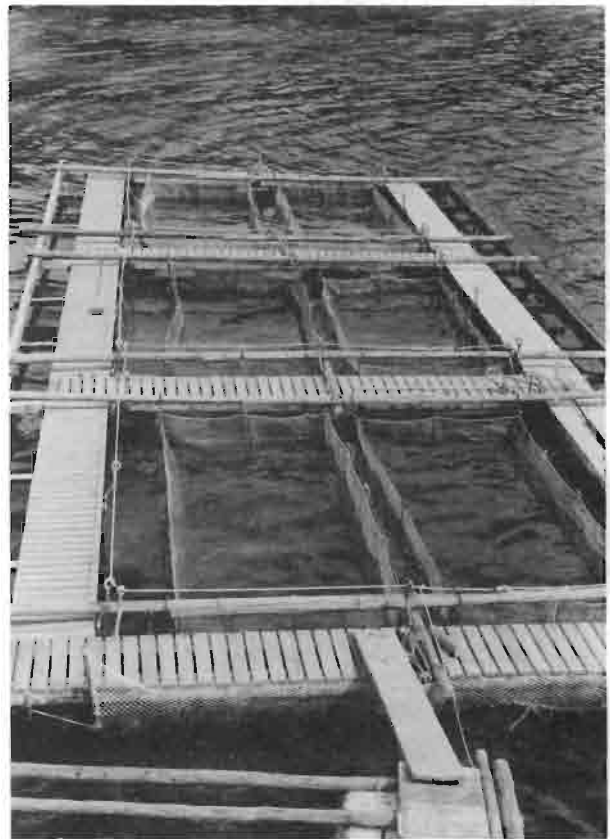

Figure 9—Raft facilities holding separate floating net cages are used for intermediate culture. The facilities anchor from each corner to bottom of about 8-15 m depth.





Figure 10—Bamboos are usually used to make culture rafts. Arrangement of the raft facilities is dependent on various conditions, such as current, ship way, and depth, in farming ground.

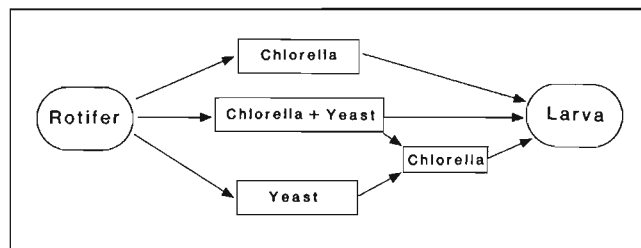

Figure 11—Conceptual diagram of rotifer culture for larval feeding of fish. *Chlorella*-cultured rotifers are fed directly to larva; rotifers fed a combination of *Chlorella* and yeast, or yeast alone, are activated by *Chlorella* prior to larval feeding.

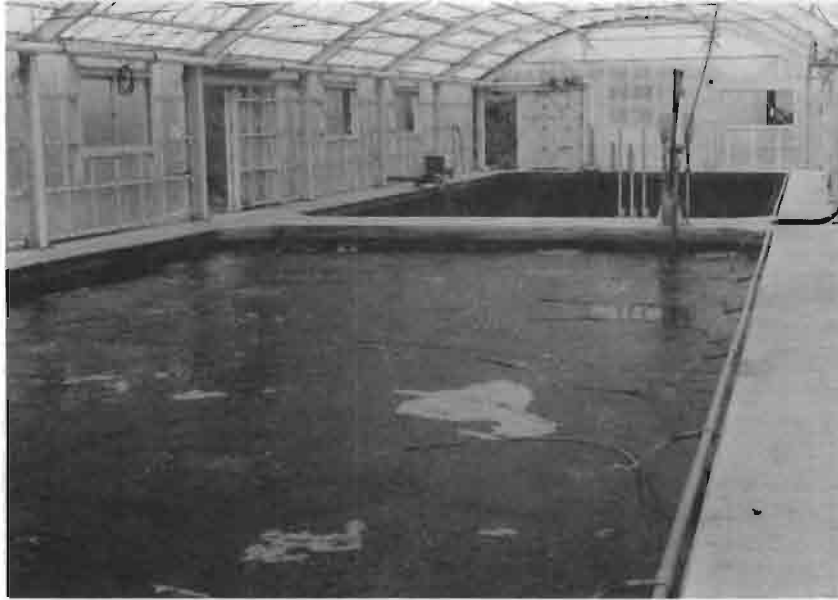

Figure 12—Indoor tank is convenient in culturing rotifers.



Figure 13—Raised seeds of *Pagrus major*. More than 5 million fish are released annually along the coastal areas.

# Culture of the Oyster *Crassostrea virginica* (Gmelin) from Seed to Market on Bedding Reefs in Barataria Bay, Louisiana, USA

EARL MELANCON, JR.  
ROANNE TRAPANI<sup>1</sup>  
GREG SCOTT<sup>2</sup>

Department of Biological Sciences  
Nicholls State University  
Thibodaux, LA 70310

LEN BAHR<sup>3</sup>  
Coastal Ecology Section  
Center for Wetland Resources  
Louisiana State University  
Baton Rouge, LA 70803

## ABSTRACT

Louisiana leads the Gulf states in oyster production. A significant part of the industry is the extensive bottom culture using oyster seed. This paper discusses commercial bedding procedures and culture techniques and gives specific examples of the problems inherent in this type of culture.

Oysters (optimum size range 25-75 mm in length) are harvested by commercial fishermen in the fall from state-managed reefs and transported and planted on private reefs located in the more saline waters near the coast where they exhibit rapid growth and good meat yield. Once bedded in the fall, the oysters are usually not harvested again until the next spring and summer when they are greater than 75 mm in length and ready for market.

In the fall of 1982, large seed oysters were bedded (44% >75 mm) on the Independence Island reef. Through the spring and summer, predation by the gastropod *Thais haemostoma* and the protozoan parasite *Perkinsus marinus* was light, probably due in part to the low salinities in Barataria Bay during the spring and summer of 1983. It is probable that had the bay's salinity remained high, oyster mortalities would have increased and reduced the harvest and financial gains of the commercial fishermen.

<sup>1</sup>Present address: Virginia Institute of Marine Science, College of William and Mary, Gloucester Point, Virginia 23062.

<sup>2</sup>Present address: Fisheries Department, Louisiana State University, Baton Rouge, LA 70803.

<sup>3</sup>Present address: 141 Washington Street, Baton Rouge, LA 70803.

## INTRODUCTION

Louisiana consistently ranks among the top states nationally in oyster production and has led the Gulf states during the past thirty years, averaging 4 million kg (9 million pounds) of oyster meat annually. During recent years the Louisiana oyster fisheries have supported an annual \$11 million industry, with the bedding of oyster seed and their subsequent harvest contributing significantly to this monetary figure.

Commercial oyster production in Louisiana has undergone a transition from harvesting only on natural reefs to the culture of oysters on planted reefs leased from the state. In the mid-19th century, Louisiana oyster fishermen realized that private ownership (today actually leased from the state for \$2 per acre) of a percentage of the state's natural oyster reefs and bedding grounds would help insure the longevity and productivity of the industry; subsequently, legislation was passed allowing public and private ownership. Louisiana's oyster grounds have, from that time to the present, been divided into two regions: state controlled "red-line" areas, and water bottoms set aside and leased to private individuals (Perret et al. 1971). As of May 1980, approximately 92,737 hectares (229,060 acres) were privately leased, while approximately 323,887 hectares (800,000 acres) were within the red-line areas. Of the state's red-line areas, 6,661 hectares (16,453 acres) are specifically reserved within five oyster seed reservations located across the Louisiana coast. Oyster populations on the seed reservations are fished when open to the public, and approximately 80,972 hectares (200,000 acres) of the remaining red-line areas are fished annually between September and March either for seed or direct-market oysters (Dugas 1977). Also, privately leased water bottoms are fished by the owners, especially if there is a limited availability of oysters on the state's reefs. This does not mean that all 92,737 hectares of privately leased water bottoms are fished annually, but it is an integral part of the industry, especially on bedding leases where oyster seed are planted for later harvest. Privately held leases can be legally fished year-round.

Perhaps there is no better area in Louisiana for discussion of oyster culture on bedding reefs than in Barataria Bay, part of one of the most productive estuarine systems in North America—Barataria Basin (Day et al. 1972). This is an area where the relatively high salinity of the Gulf of Mexico influences the development and survival of seed oysters (Fig. 1). Van Sickle et al. (1976) estimated that 3,329 hectares (8,223 acres) of water bottom were leased in Barataria Bay and adjacent marshes by the private sector in 1975. Although dock-side production figures are generally incomplete, this basin is one of the major oyster producing areas in the state. However, only a percentage of bedding leases in the lower bay are planted and fished annually, leaving the remaining fallow beds alone for one or two years to recover from dredging and hopefully to reduce the incidence and concentration of predators, especially the oyster drill *Thais haemostoma*.

## CULTURE TECHNIQUES

In contrast to the intensive off-bottom culture practiced in Japan and other countries, Louisiana's oyster industry is an extensive bottom-type semiculture. Oyster fishermen, i.e., culturists, must rely on nature to supply them with oyster seed. Once the seed is transplanted to the private bedding reefs, it becomes the fisherman's responsibility to oversee the survival, growth, and eventual harvest of the oysters for market.

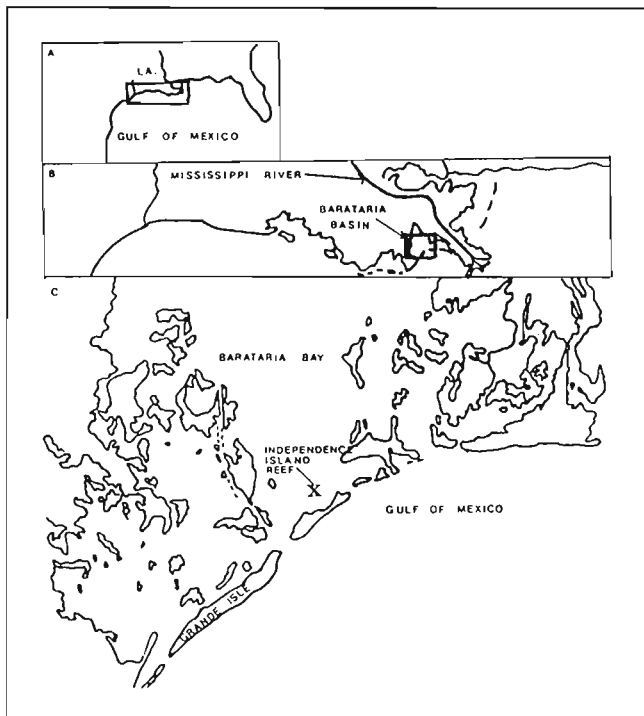

Figure 1—Barataria Bay, Louisiana.

In the early years of this century, the Louisiana oyster industry experienced a transition from sail-powered to motorized vessels and from hand tongs to mechanical dredges to harvest oysters. These two advances allowed fishermen the opportunity to expand their range and to increase their productivity. The term “lugger” is used to denote the traditional oyster vessel. Oyster vessels used in Barataria Bay typify the traditional large lugger and range from 15.5 to 18.2 m (50-60 ft) in length and 5.4 to 6.7 m (18-22 ft) in width. The hull is constructed of either cypress or steel and is powered by a diesel engine. The two dredges, each 1.4 m (56 in.) wide, fish simultaneously on both sides of the vessel and are alternately winched aboard to dump the oysters on the deck; by this method one dredge is always fishing. A crew consists of a captain and two or three mates.

Seed oysters for the bedding reefs are obtained from state-managed oyster reefs on which hydraulically dredged clam shells (*Rangia* sp.) or naturally occurring oyster shells are used as cultch for the oyster spat to set. The seed oysters are harvested one year after setting and transplanted to private bedding reefs from September through November when they are 25 to 75 mm (1-3 in.) in length. Figure 2, taken from St. Amant (1957), shows the preferred size range of bedded seed oysters. In lower Barataria Bay, the commercial fishermen prefer 50 to 60 mm length seed oysters because they believe the larger size will insure a higher survival rate during transporting and bedding, and from predators.

With the relatively high salinities and temperatures that usually prevail in the lower bay, predation and disease are quite prevalent and the naturally occurring subtidal oyster populations will succumb quickly. For these reasons the bay’s bedding reefs are often devoid of any natural oyster populations and are used only for short periods of time in the cultivation of transplanted seed stock. Through the fall and winter months, after the fishermen have bedded their seed, they return either to the state’s public reefs or to other privately leased natural reefs to fish for market-size oysters for direct sale to shucking houses or canning factories. Not until the following

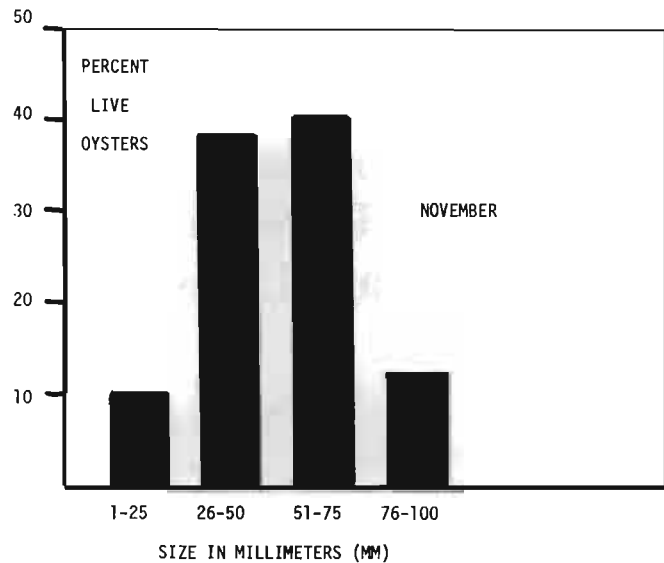

Figure 2—Size frequency of normally bedded oysters in Barataria Bay, planted in November (from St. Amant 1957).

spring and summer do most fishermen return to the bedding reefs to harvest the now 75 to 125 mm length oysters for market. If the bedded oysters are large, some fishermen may begin harvesting by November or December instead of waiting until spring. Seed oysters remain on the bedding reefs no longer than six to ten months because of predation and disease.

### INDEPENDENCE ISLAND REEF

One example of a bedding reef is Independence Island, located at the southern end of the bay behind the barrier island Grande Terre. The name implies the presence of a land mass, but the island long ago eroded away leaving only a cluster of wood pilings visible above the water. These pilings are all that remain of an old oyster camp that once housed as many as 30 to 40 oyster fishermen, i.e., laborers, during the first quarter of this century and before the advent of refrigeration, motorized vessels, and mechanical dredges. The massive, subtidal, hard oystershell reef is still present, however, and is used extensively by commercial fishermen to plant their seed oysters. In the fall of 1982, six oyster vessels bedded oysters on the massive reef. Each lease, except numbers 4 and 5, was approximately 0.4 hectares (1 acre) in area; numbers 4 and 5 were approximately half that size.

### SIZE, DENSITY, AND GROWTH OF BEDDED OYSTERS

As stated earlier, seed stock in Louisiana is dependent primarily on the natural spat set that occurs on the state-managed oyster grounds. In September of 1982 when the state reefs were opened to commercial fishermen, they quickly discovered that the majority of oysters available as seed stock were large. Such oysters could hardly be called true seed, but the fishermen had no choice but to

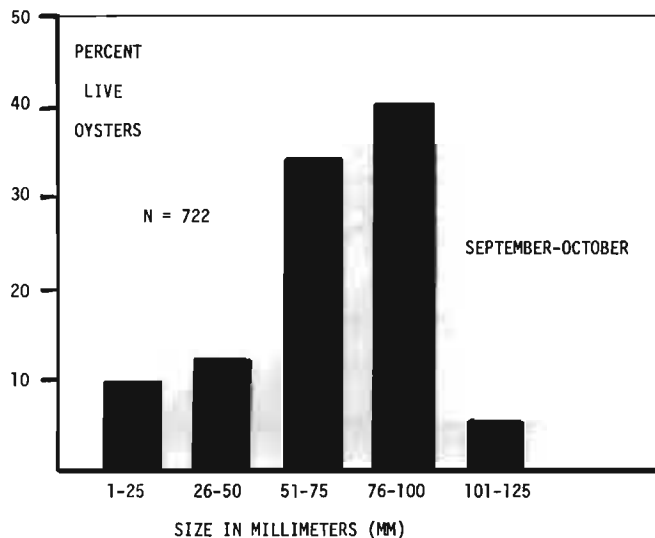

Figure 3—Size frequency of bedded oysters on Independence Island reef, planted fall 1982.

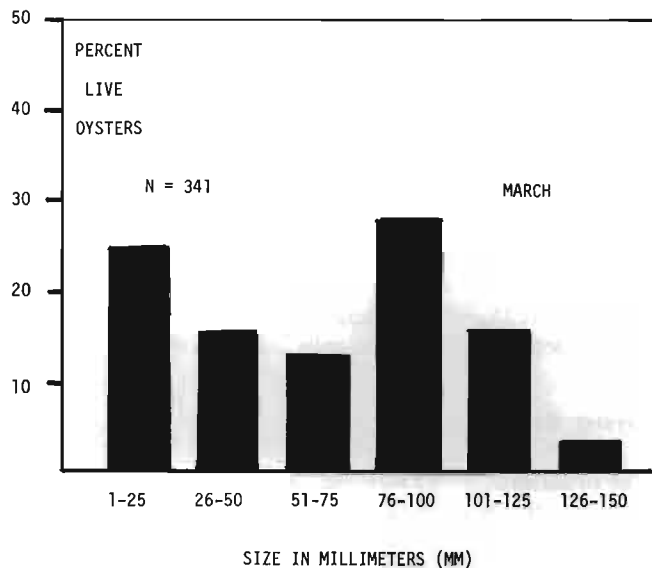

Figure 4—Size frequency of bedded oysters on Independence Island reef, spring 1983, after fall-winter growth.

bed the large oysters or not bed at all. A survey revealed that approximately 44% were greater than 75 mm in length, the minimum legally harvestable size for direct sale (Fig. 3). It is not unusual, however, to have market-size oysters mixed with the seed since the majority of the stock comes from the natural reefs located on the public grounds. The sizes of oysters available for seed from these natural reefs are dependent on many environmental and market factors over which the Louisiana Department of Wildlife and Fisheries (LDWF) has little or no control. Often, only when the LDWF plants cultch material, i.e., clam shell, and regulates when the area can be harvested, can a crop of true seed (25-75 mm) be produced for the industry.

Day et al. (1972) estimated the density of an average planting of 37 to 50 mm seed oysters in Barataria Bay at 110 oysters per square meter. The mean density of oysters on lease 1 was  $42 \pm 25.4/m^2$ , while on lease 2 it was  $103 \pm 46.0/m^2$ . There is often a large variation in density from one location to the next within a lease due largely to the method of bedding the seed; water pressure from a deck hose is used to distribute the seed across the lease while the vessel is circling, often resulting in patchiness and uneven distribution.

The distance oyster vessels must travel from the public grounds to their bedding reefs often compounds a fisherman's problem of finding adequate seed. It is not uncommon for fishermen bedding in Barataria Bay to travel over 129 km (80 miles) one-way, requiring as much as 11 hours travel time. Due to the distance, Barataria Bay is considered the maximum range of bedding from the public reefs located east of the Mississippi River. Once bedded, the vessels return to the public reefs for another load. A fisherman may bed 8 to 20 loads, depending on the availability of oysters and market conditions, with each load averaging 200 to 250 barrels of seed. On the public reefs, every fisherman has the legal right and opportunity to harvest oysters. Competition, therefore, is keen and a fisherman cannot afford the luxury of wasted time, especially with such a finite resource. Except to get fuel or supplies, the vessels seldom stop until all the desired seed has been bedded.

Fishermen determine the quantity of seed oysters being transported by observing the area occupied by the compactly piled unsacked load on the foredeck. Most fishermen, through experience, know the carrying capacity of their vessel, thus enabling them to determine the number of barrels planted by keeping a record of the number of barrels hauled per trip. By volume, one barrel of oysters is equivalent to three Louisiana bushels, 0.1 cubic meters, which also equals two oyster sacks. The larger the oyster seed, the fewer the number of oysters in a barrel and therefore the fewer the number of oysters planted per trip. However, dredged material is not totally comprised of oysters; on the contrary, old dead reef shell and clam shell are also hauled on deck. The fishermen, again through the experience gained by operating their dredges, try to keep the quantity of reefshell to a minimum by scraping off only the top layers of reef where the live oysters rest. At the present time, Louisiana does not require the return of discarded oyster shells from the shucking houses to the state's reefs.

A resurvey in March 1983 revealed a shift in the oyster population's size-distribution indicating that significant growth had occurred (Fig. 4). The size-distribution figures were somewhat clouded, however, by the presence of a relatively large number of 1-25 mm oysters which indicated that a natural spat set had occurred on the reef since planting. It is not unusual to have a fall-winter spat set occur, but these oysters were too small to be harvested for spring and summer sale and either died from dredging and predators or were later harvested and transported to less saline waters for future sale.

## PREDATION AND DISEASE

Many marine organisms prey upon the immobile oyster, but the three principal organisms causing extensive oyster mortalities on the bedding reefs are the predaceous conch *Thais haemastoma*; the disease producing protozoan *Perkinsus marinus*, colloquially known as dermo; and the black drum fish *Pogonias cromis*. The black drum fish is dominant during the fall and winter months, while the conch and protozoan become increasingly active during the spring and summer with a rise in water temperature above 20°C (68°F) and salinity above 15 ppt. It is because of *T. haemastoma* and *P. marinus* that bedded bay oysters are usually harvested by early summer.

### Oyster drill

The oyster drill, *T. haemastoma*, is very common in the saline waters of Barataria Bay and can cause extensive mortalities to bedded oyster populations. The combination of drilling with its radula and the secretion of a paralytic substance is currently recognized as the gastropod's method of attack (Breithaupt and Dugas 1979). Interviews with the Independence Island fishermen and monthly reef surveys taken through the spring and summer revealed that few drills were evident on the leases. The drill infestation was considered very light by the fishermen, and few of the gastropod's eggs were evident on the harvested oysters and reefshells. Conversations with commercial fishermen and biologists at the LDWF Lyle S. St. Amant Marine Laboratory on Grande Terre Island indicated that the salinity in the bay fluctuated dramatically and suddenly throughout most of the spring and early summer. The bay's salinity is greatly influenced by precipitation in the northern areas of the basin and by the Mississippi River's discharge in the south; both set high records in the spring and summer of 1983. This perhaps created an environmental barrier that prevented the oyster drill from being abundantly distributed across the reef. A survey of soft mud areas adjacent to the reef revealed the presence of drills, indicating that they did inhabit the area but were relatively inactive. St. Amant (1957) discusses how the drill burrows into the soft mud and becomes relatively inactive to protect itself from adverse environmental conditions such as fluctuating temperatures and salinities; this may have been the case here. Figure 5 shows weekly temperature and salinity measurements.<sup>4</sup>

### Dermo

Dermo is a parasite that has plagued the Louisiana oyster fishermen for decades and it is the primary cause for what they refer to as the "summer mortalities". Infection by dermo has significant economic implications. Fishermen know that leaving bedded oysters on the reefs through late summer may mean financial disaster. Although the parasite is found in other organisms, dermo is usually considered specific for the American oyster because of the large-scale mortalities associated with its presence in their tissues. Most oyster tissue will harbor the parasite, but the gills, rectum, mantle, and adductor muscle appear to be the most infected areas (Overstreet 1978). It is not until the oyster has a moderate-to-heavy infection that it begins showing any signs of weight loss or other visible characteristics (Ray et al. 1953). Young oysters

<sup>4</sup>Temperature and salinity data for Independence Island, 1982-83, courtesy of personnel from the LDWF's Lyle S. St. Amant Marine Laboratory, Grande Terre Island, Louisiana.

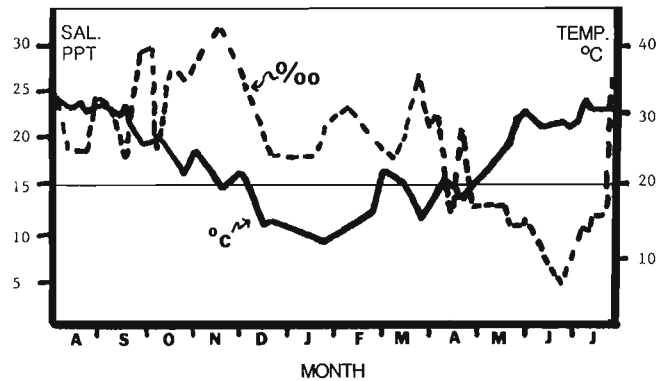

Figure 5—Temperature and salinity on Independence Island reef, 1982-83 season.

do not develop dermo as readily or as severely as older oysters, and it is not until the second or third summer of growth that many succumb to the parasite (Mackin 1961). For these reasons, the oyster population bedded on Independence Island in the fall of 1982 could experience heavy mortalities the following summer since the majority would be in their second and third summer of growth.

A monthly survey of dermo was conducted from early spring through summer. The spring (1 March-29 April) and summer (8 June-25 July) exhibited much similarity in the occurrence of dermo. Contrary to expectation, neither the frequency nor the degree of infection increased from spring to summer. Dermo was abundant within the Independence Island population with 57% harboring the parasite during the spring and summer. The weighted incidence (WI) remained light, however, averaging 1.06 and 1.18 during the spring and summer, respectively (using the WI scale of Quick and Mackin 1971). Similarities between spring and summer probably were partially due to the relatively low salinities that prevailed during 1983. Dermo is known to become increasingly active with the synergistic effects of rising temperatures and salinities (Soniati 1985). In this instance, the two environmental parameters did not coincide. During the spring the water temperatures were still relatively low while salinities remained high. In contrast, during the summer the opposite prevailed with temperatures high and salinities low. If a hot dry spring and summer had occurred, higher salinities would have prevailed and higher oyster mortalities probably would have occurred resulting in considerable financial loss to the fishermen.

### Black drum

A third predator that can cause extensive damage to a bedded oyster population is the fish *P. cromis*. During the fall and winter months, this fish can often be found in large schools of 100 or more and can literally devour a bedded oyster population within a few days. One has only to look at the jaws and teeth of these large fish to see how they can easily crush an oyster's shell. Usually after bedding in the fall, the fishermen will not disturb their lease again until they are ready to harvest for sale. Fishermen believe that disturbing the oysters after bedding will increase the chance of attracting the drum. Whether fact or superstition, the fishermen of Barataria Bay are governed by this belief. This had an effect on our sampling schedule.

When the fishermen began harvesting their leases in the spring, there were no apparent signs of widespread mortalities due to drum predation.

## HARVEST STATISTICS

At no time during this study was an unusually high degree of oyster mortality observed; mortality was estimated by counting the number of empty hinged boxes. The observed monthly mortality was never in excess of 5-10% of the population during any given spring and summer month. Other scientists have found mortality ranges of 30-100% (Mackin and Hopkins 1961), 15-77% (Owen 1953), and 16-44% (St. Amant 1957) during a bedding season.

It has been estimated that a boatload of seed oysters planted in the fall of one year will yield one to three boatloads of marketable oysters by the following summer (Dugas 1982). Many seed oysters may die either from the transplanting trip or from predators and disease while on the bedding reefs. To insure a profit, the fishermen must compensate by bedding many seed oysters, although this is often difficult for the bay fishermen because of the distance they must travel and the limited availability of public seed. Fishermen who bed in the basin to the east of the bay are closer to the public reefs and can often make two trips to every one made by the bay fishermen. Owen (1953) suggests that a fisherman can make a profit if, for every sack of seed oysters planted, one sack of market oysters is harvested. This would produce a one-to-one yield compensating for oyster growth, mortality, and the bedding of accidentally collected old reef shells. Table 1 shows the number of barrels planted and the number of sacks harvested by each vessel.

A thorough discussion of economic factors involved in the bedding and harvesting operations of a commercial oyster business is beyond the scope of this study. Most expenses during this study were incurred during transplanting of the seed from the public reef, expenses incurred with no monetary return until the following spring and summer. All but one fisherman produced a yield ratio greater than one-to-one. Interviews with the bay fishermen indicated that they all made a profit on the 1982 seed crop.

The bay fishermen worked and harvested the bedding reefs from early spring through early summer, and in two cases through July to mid-August, thus barely giving them time to rest or to repair their vessels before the new September season on the public reefs. Oysters were harvested and sold to the shucking houses by the sack, usually containing 168 to 180 oysters each. At the shucking house, the sacks were opened and oysters processed as a raw-shop product.

Table 1—Commercial oyster statistics for Independence Island Reef, 1982-83 season.

Vessel	Lease	No. sacks bedded	No. sacks harvested	Sack ratio Bedded:Harvested
A-B	1-2	6,780	8,333	1:1.23
C	3	4,400	5,138	1:1.17
D	4	2,000	819	1:0.41*
D	5	2,000	2,505	1:1.25
E	6	3,720	4,168	1:1.12
F	7	4,750	5,777	1:1.22
Average				1:1.13

\*Low ratio may be due to fall oyster drill predation; lease 4 not actually located on Independence I., but near.

## OVERVIEW

The oyster bedding industry is dependent on a successful seed crop from the state reefs. Many believe that the present economic conditions in Louisiana do not warrant the development of commercial seed hatcheries even though reliance on natural seed brings fluctuations of scarcity and abundance. To insure the longevity and development of the industry to its maximum potential, a consistent and large supply of 25 to 75 mm seed oysters is mandatory. Possible solutions, other than hatcheries, to the problem of scarce seed stock are (1) supervised shell plants for cultch material (a practice already implemented by the LDWF), and (2) controlled and regulated freshwater diversion onto the state's prime oyster seed grounds to slow or reverse the trend of encroaching high-salinity waters.

## ACKNOWLEDGMENTS

Without the support and cooperation of the Barataria Bay oyster fishermen, this project could not have been conducted. This study was funded partially by the NSU Research Council and the Coastal Fisheries Institute, Center for Wetland Resources, LSU. Logistical support was furnished by Louisiana Universities Marine Consortium (LUMCON) and the LDWF's Lyle S. St. Amant Laboratory. Part of this work is being included in the senior author's doctoral thesis at the Coastal Fisheries Institute, LSU.

## CITATIONS

- BREITHAUPT, R. L., and R. J. DUGAS.  
1979. A study of the southern oyster drill (*Thais haemastoma*) distribution and density on the oyster seed grounds. La. Dep. Wildl. Fish., Tech. Bull. 30, 20 p.
- DAY, J. W., W. G. SMITH, P. R. WAGNER, and W. C. STOW.  
1972. Community structure and carbon budget of a salt marsh and shallow bay estuarine system in Louisiana. Sea Grant Publ. LSU-SG-72-04, Louisiana State Univ., Baton Rouge, 80 p.
- DUGAS, R. J.  
1982. The Louisiana oyster. La. Dep. Wildl. Fish., Educ. Bull. 32, 33 p.  
1977. Oyster distribution and density on the productive portion of state seed grounds in southeastern Louisiana. La. Dep. Wildl. Fish., Tech. Bull. 23, 27 p.
- MACKIN, J. G.  
1961. Oyster disease caused by *Dermocystidium marinum* and other microorganisms in Louisiana. Publ. Inst. Mar. Sci. Univ. Tex. 7:132-229.
- MACKIN, J. G., and S. H. HOPKINS.  
1961. Studies on oyster mortality in relations to natural environments and to oil fields in Louisiana. Publ. Inst. Mar. Sci. Univ. Tex. 7:1-131.
- OVERSTREET, R. M.  
1978. Marine maladies? Worms, germs, and other symbionts from the northern Gulf of Mexico. Gulf Coast Res. Lab., Ocean Springs, Miss., 140 p.
- OWEN, H. M.  
1953. Growth and mortality of oysters in Louisiana. Bull. Mar. Sci. Gulf Caribb. 3(1):44-54.
- PERRET, W. S., B. B. BARRETT, W. R. LATAPIE, J. F. POLLARD, W. R. MOCK, B. G. ADKINS, W. J. GAIDRY, and C. J. WHITE.  
1971. Cooperative Gulf of Mexico estuarine inventory and study: Phase I, Area description, and Phase IV, Biology. La. Dep. Wildl. Fish., 59 p.
- QUICK, J. A., Jr., and J. G. MACKIN.  
1971. Oyster parasitism by *Labyrinthomyxa marina* in Florida. Fla. Dep. Nat. Resour. Mar. Res. Lab., Prof. Pap. Ser. 13, 55 p.
- RAY, S. M., J. G. MACKIN, and J. L. BOSWELL.  
1953. Quantitative measurement of the effect on oysters of disease caused by *Dermocystidium marinum*. Bull. Mar. Sci. Gulf Caribb. 3(1):6-33.

SONIAT, T. M.

1985. Changes in levels of infection of oysters by *Perkinsus marinus*, with special reference to the interaction of temperature and salinity upon parasitism. *North-east Gulf Sci.* 7(2):171-174.

ST. AMANT, L. S.

1957. Growth and mortality rates of Louisiana oysters. *La. Dep. Wildl. Fish., Seventh Bienn. Rep.*, p. 71-95.

VAN SICKLE, V. P., B. B. BARRETT, T. B. FORD, and L. S. GULICK.

1976. Barataria Basin: salinity changes and oyster distribution. *Sea Grant Publ. LSU-T-76-002*, Louisiana State Univ., Baton Rouge, 35 p.



# Seed Oyster Production in Louisiana and Prospects for Enhancement

MARK CHATRY

*Lyle S. St. Amant Laboratory*

*Louisiana Department of Wildlife and Fisheries*

*P.O. Box 37*

*Grand Isle, LA 70358*

## INTRODUCTION

---

Despite the many and diverse methods of oyster culture practiced throughout the world, the success of all methods is dependent primarily upon consistent availability of low cost, high quality seed. The Louisiana oyster *Crassostrea virginica* (Gmelin) fishery has evolved over the past 150 years from the indiscriminant harvesting of natural reefs to a regulated, semiculture operation which encourages judicious use of the State's seed resources. This paper examines the development of the fishery and its sources of seed along with efforts of the Louisiana Department of Wildlife and Fisheries and other government agencies to ensure continued availability of seed oysters.

## DEVELOPMENT OF THE FISHERY AND SEED SOURCES

---

Coastal Louisiana is characterized by extensive estuarine areas created over the past 5,000 years by the deltaic processes of the Mississippi River. Oyster populations have flourished and declined in the vicinity of each of the emerging and retreating delta lobes. While oysters have undoubtedly been exploited in this region since prehistoric times, the first commercial operations took place around 1800 in the estuaries near the present Mississippi River Delta. In those early days, oysters were harvested directly from the natural reefs, usually by the hands of fishermen wading in waist-deep water. Oyster culture as practiced in Louisiana today had its beginning in the mid-1800's. Immigrant fishermen from Dalmatia, who settled in fairly large numbers in the Mississippi River Delta, realized that high quality oysters could be produced by transferring seed from the natural reefs to bedding grounds closer to the Gulf of Mexico. These higher salinity areas did not support substantial natural populations, due to the inability of recently set oysters to survive the heavy predation, but were excellent for fattening and growth of transplanted seed. Increased demand in the late 1800's for these superior transplanted oysters, along with improved harvesting techniques, namely oyster tongs and the dredge, prompted the fishermen to recommend State Legislation which was both supportive of their method of cultivation and protective of the natural reefs as a source of seed.

By the turn of the century the State's oyster producing areas had been divided into public seed grounds and private bedding grounds. The public grounds included the most productive natural reef areas east of the Mississippi River (Fig. 1). The private grounds were designated as all oyster producing areas in the State, excluding the public grounds, and were made available for leasing. Leasing procedures were placed under the jurisdiction of the Oyster Commission of Louisiana. Additionally, the Commission was made responsible for supplying a source of seed oysters on the public grounds.

Thus, the basic organization of the fishery had been established. The State supplies the seed, and the private leaseholders grow the seed to market size. This system has endured over the years with the fishermen dredging the public seed grounds each fall, loading their boats with year-old 25-76 cm seed, and transporting and bedding the seed on their leases. An individual fisherman may make 20-25 trips per year from the seed grounds to his leases which may be over 80 km away. The seed usually remains on the leases for six to nine months before harvesting, with each boatload of seed returning one to two boatloads of market oysters. If, in a given year, there is an overabundance of seed on the public grounds, market oysters (>76 cm) are dredged on the grounds the following

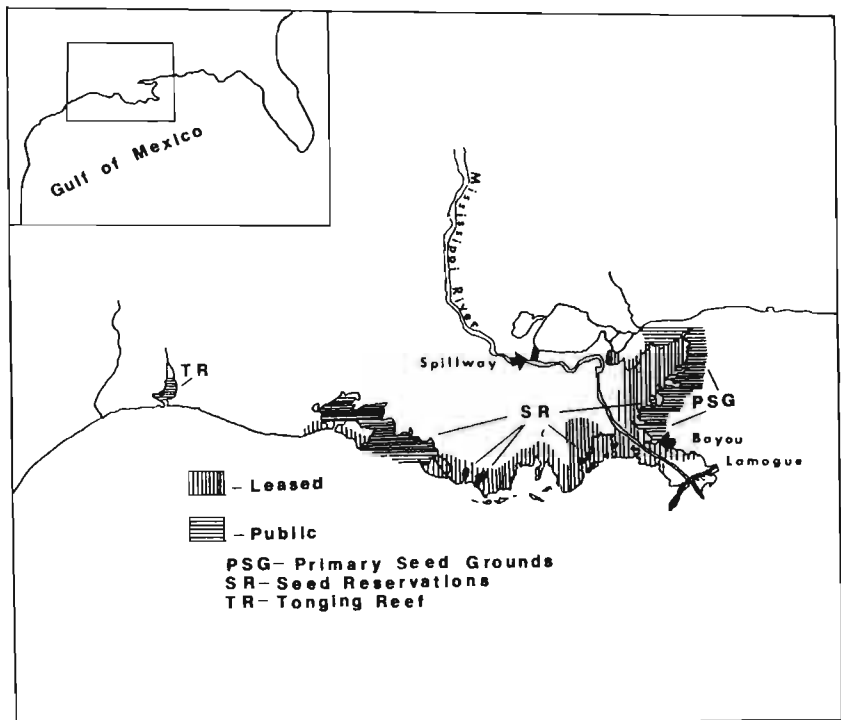

Figure 1—Oyster growing areas of Louisiana.

year, and are either sold directly or used as seed.

In the mid-1900's the State established five seed oyster reservations, one east and four west of the Mississippi River, to supplement seed production on the public oyster seed grounds (Fig. 1). The reservations are usually opened on alternative years, as opposed to the public seed grounds which are opened every year.

## SEED PRODUCTION ENHANCEMENT

The Louisiana Oyster Commission, along with its antecessors the Conservation Commission and the Seafood Division of the Department of Wildlife and Fisheries, has generally met its responsibility to produce seed, as evidenced by the consistency of Louisiana oyster landings over the years (Table 1). This has been accomplished through identification of the factors limiting seed production and implementation of several combative strategies.

Seed production is limited by extreme high and low salinities throughout the peak spawning season (June-September) and by lack of suitable substrate for larval settlement. A narrow range of mean spawning season salinities, 12-17 parts per thousand (ppt), is associated with successful production of seed (Chatry et al. 1983). Mean spawning season salinities <12 ppt inhibit gametogenesis and reduce larval survival, resulting in insufficient numbers of mature oyster larvae. At salinities >17 ppt, mature larvae are abundant but setting and survival of recently set oysters is poor due to increased numbers of fouling organisms and predators.

Salinities on the public seed grounds have been increasing steadily for the past 50-60 years due to improvements in the Mississippi River levee system and from channelization, subsidence, and erosion of the coastal marshes. As saltwater intrusion progressed, the narrow range of salinities associated with successful production of seed has moved away from historically productive reefs and into areas lacking suitable substrate for larval settlement. In order to maintain or increase levels of seed production, the State has created

Table 1—Oyster harvest in Louisiana, 1940-82<sup>1</sup>.

Year	Harvest (kg <sup>3</sup> meat)
1940	5,623
1950	3,948
1960	3,765
1961	4,593
1962	4,603
1963	5,238
1964	5,165
1965	3,779
1966	2,158
1967	3,507
1968	5,944
1969	4,158
1970	3,913
1971	4,769
1972	3,989
1973	4,056
1974	4,517
1975	6,196
1976	5,587
1977	4,559
1978	4,377
1979	3,494
1980	3,147
1981	4,119
1982	5,454

<sup>1</sup>Historical Catch Statistics: U.S. Fish Wildl. Serv. Bur. of Commer. Fish., and Natl. Mar. Fish. Serv., NOAA.

new reefs through cultch plants, reestablished old reefs with the controlled diversion of freshwater from the Mississippi River, and is currently working with the U.S. Army Corps of Engineers to build additional, more efficient, diversions.

## Cultch Plants

Since 1926, the State has planted over 1 million m<sup>3</sup> of cultch material on public seed grounds and reservations for the purpose of creating new reef areas or increasing production on existing reefs. Steam plant oyster shell, returned to Louisiana by Mississippi canneries, was the primary material used prior to 1956. In the late 1950's and early 60's, reef oyster shell dredged from relic reefs along the central Louisiana coast was used to supplement steam plant shell (St. Amant 1959). Clamshell (*Rangia cuneata*) has been the preferred cultch material since the mid-1960's due to its availability and because it generally produces well-shaped oysters that require minimal culling.

Clamshell is dredged hydraulically from vast deposits in Lake Pontchartrain, loaded onto flush deck barges, and transported to the seed grounds. The shell is planted using a specially designed "spray barge" with a high-pressure water pump and four to six nozzles (Fig. 2). Streams of water are directed at the loaded clamshell barge, and the shell is washed overboard in a thin, even layer for a distance of 9-12 m from the barge. The speed at which the two barges are maneuvered determines the planting rate (usually 94-188 m<sup>3</sup>/ha).

The selection of a cultch plant site depends upon the suitability of the bottom and the anticipated salinity conditions. The bottom must be of sufficient firmness and stability to prevent the cultch material from sinking or being buried, and salinities should be within the range previously described as optimal for seed production. Ideally, the shell is planted immediately preceding a spatfall. If no set occurs within several weeks of planting, the shell becomes fouled and therefore less attractive to setting larvae. Due to the protracted spawning and setting season, however, successful shell plants have been made from April to September. Most shell plant failures are due to inability to predict salinity conditions consistently and hence predict the production of mature larvae or survival of recently set oysters.

Successful shell plants in Louisiana have had cost:benefit ratios as high as 20:1 (Schafer 1972). Unfortunately, the cost of clamshell is escalating rapidly. Research is underway to find suitable substitutes for clamshell and to more precisely identify the environmental conditions associated with successful plants.

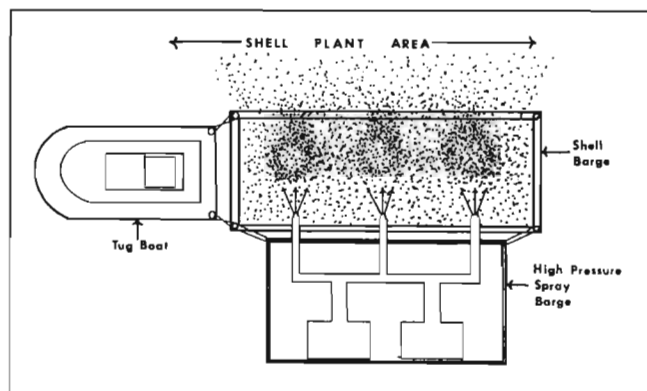

Figure 2—Arrangement of tugboat, shell barge, and spray barge for the planting of cultch material.

## Freshwater diversion

Despite the State's ambitious cultch planting program, there have been partial or total failures of oyster set on the public grounds for eight of the past ten years (Table 2). Most of the failures have been related to the occurrence of high salinities over the entire seed grounds. The two years in which the most successful oyster sets were recorded were marked by openings of the Bonnet Carre Spillway, a flood control structure of the Mississippi River (Fig. 1), which reduced salinities throughout the seed grounds. In both cases, the large number of oysters resulting from the successful set sustained the industry for several years. The Spillway, however, is used only when floodwaters threaten the City of New Orleans and therefore cannot be relied upon to consistently reduce salinities for the production of seed oysters.

Table 2—Seed abundance (25-76 cm oysters) on Louisiana's primary seed grounds, 1974-83.

Year	Thousands of Barrels <sup>1</sup>
1974	2,436
1975	700
1976	503
1977	341
1978	206
1979	69
1980	2,376
1981	908
1982	360
1983	76

<sup>1</sup>1 Barrel = 106 L or approximately 720 seed oysters.

The State has long realized the disastrous effects of saltwater intrusion on the productivity of the seed grounds and also the potential value of freshwater diversion. In 1958 a freshwater diversion structure was built at Bayou Lamoque to supply Mississippi River water to a portion of the seed grounds (Fig. 1). The structure has been highly successful in increasing seed production, but its area of influence is relatively small due to the limited capacity of the structure and the circulation pattern of the region which tends to carry the freshwater away from the seed grounds.

The U.S. Army Corps of Engineers has proposed a comprehensive plan for large-scale controlled freshwater diversion from the Mississippi River to the estuarine areas of southeast Louisiana. Tentative sites for the diversion structures are located near the top of their respective estuarine basins so that the greatest possible area will be impacted. Benefits to be realized from diversions include reduced coastal erosion, preservation of fresh and brackish water marshes, and general enhancement of fish and wildlife resources. Seed oyster production will increase dramatically due to the establishment of favorable salinities over vast acreages of formerly productive reefs. The magnitude and timing of the diversions will be controlled to create salinity conditions similar to those which occurred during years of highly successful oyster set. As a result, seed abundance on the public grounds should consistently equal or surpass the quantities recorded in 1974 and 1980. This increased availability of seed should allow for considerable expansion of the oyster industry in Louisiana.

Both cultch plants and freshwater diversion, if properly executed, enhance the production of seed oysters. Cultch plants, however, are merely stopgap measures which will lose their effectiveness as salinity intrusion progresses. For this reason, freshwater diversion offers greater hope for the future of the Louisiana oyster industry.

## CITATIONS

---

- CHATRY, M., R. J. DUGAS, and K. A. EASLEY.  
1983. Optimum salinity regime for oyster production on Louisiana's state seed grounds. *Contrib. Mar. Sci.* 26:81-94.
- SCHAFER, H. E.  
1972. Louisiana oyster fishery. *In Proc., Public Symposium on the Oyster Fisheries of the Gulf States*, October 6, 1972. Gulf Coast Res. Lab., Ocean Springs, Miss.
- ST. AMANT, L. S.  
1959. Successful use of reef oyster shells as oyster cultch in Louisiana. *Proc. Natl. Shellfish. Assoc.* 49:76-76.

# Penaeid Shrimp Culture in the United States: A Brief Overview Stressing Species, Seed Production, and Growout

ADDISON L. LAWRENCE  
*Texas A&M University*  
*P.O. Drawer Q*  
*Port Aransas, Texas 78373*

JAY V. HUNER  
*Center for Small Farm Research*  
*College of Agriculture*  
*Southern University*  
*Baton Rouge, Louisiana 70813*

## INTRODUCTION

---

Americans consume huge quantities of shrimps annually, especially those species belonging to the family Penaeidae. Annual landings appear to have stabilized around 90 million kg with a dockside value of \$500-600 million. Yet despite this substantial domestic production, an additional \$1 billion plus worth of shrimp, mostly penaeids, is imported each year. Thus, there is great motivation to develop additional domestic sources of shrimps (Lawrence et al. 1981a, b; 1983a, b). Mariculture is the obvious avenue to pursue, and shrimp mariculture research can be traced back to the 1950's when Lunz initiated culture studies at the coastal Bears Bluff Laboratory in South Carolina (Lunz 1951, 1956, 1958, 1967). Additional penaeid shrimp growout studies in ponds have been conducted in states bordering the Gulf of Mexico, including Florida (Caillouet et al. 1976), Alabama (Tatum and Trimble 1978; Trimble 1980), Louisiana (Broom 1968; de la Bretonne and Avault 1970; Latapie et al. 1972; Neal and Latapie 1972; Rose et al. 1975), and Texas (Parker 1972; Parker and Holcomb 1973; Parker et al. 1974; Elam and Green 1974; Chamberlain et al. 1980, 1981; Lawrence et al. 1983c; Davis and Johns 1984; Johns and Davis 1984; Smith 1984). This area produces the bulk of the nation's penaeid shrimp harvest, and cultural efforts are certainly a natural outgrowth of the region's commitment to a shrimp fishery and its suitable, although not ideal, climate for shrimp culture.

While early penaeid growout studies showed much promise, they were continually plagued by problems associated with obtaining hatchery-reared rather than wild-caught shrimp seed, with the growth responses and survival of native species, and with the absence of well defined pond feeds. Although the natural life cycle of penaeid shrimps was well understood, it was difficult to produce shrimp seed with consistency when relatively scarce, mated female shrimp had to be caught in open waters by trawlers. Further, hatchery procedures were not well established, diseases were a problem, and female shrimp could not be matured and mated in captivity at that time. A good review of the early problems encountered by shrimp culturists is provided by Hanson and Goodwin (1977).

The U.S. Government initiated studies in the 1960's to solve these problems. These studies coincided with a significant amount of research and development by a number of major U.S. corporations. While many problems were overcome, commercial support for a developing U.S. shrimp mariculture industry either evaporated or was transferred to more favorable regions in South and Central America, where problems such as a seasonal growing period, private and government resistance to development of wetlands, and high labor costs could be more readily overcome. There, too, spawning female shrimp were more readily available and wild seed shrimp were abundant and could be taken from coastal waters without extensive objections from environmental groups and the existing shrimp fishing industry. A summary on shrimp culture activities in Ecuador, which is producing more shrimp in ponds than any other country in the world, has recently been reported (Hiron 1983).

Significant strides have been made in overcoming impediments to shrimp mariculture in the United States, including Hawaii. The major remaining obstacle to extensive commercial penaeid shrimp mariculture today is obtaining dependable supplies of viable fertilized eggs from captive shrimp broodstock (Lawrence et al. 1983a, b). However, one private firm is raising shrimp semi-intensively in 55 hectares of open ponds in south Texas, and private firms are developing 25 hectares of ponds in Hawaii (Anonymous 1983).

Texas ponds have the capacity for growing 950-2,350 kg of shrimp/ha in a 6.5-7.5 month growing period during the warm months, and this shows an acceptable profit. The University of Arizona is currently developing, with industrial support, intensive raceway culture systems in Hawaii that are said to be capable of yielding 5 kg of shrimp/m<sup>2</sup> 2½ times per year. Although expensive, the economics of the system are such that commercial development is now expected in the next year (D. V. Lightner, Environ. Res. Lab., Univ. Arizona, Tucson, AZ 85706, pers. commun. 1983). A project costing close to \$50 million which utilizes this intensive culture system is being planned by W. R. Grace and F. H. Prince Companies in Singapore (Anonymous 1984). Finally, abandoned coastal rice fields are being developed for low-input extensive shrimp mariculture in South Carolina on the southeastern U.S. Atlantic Coast (T. I. J. Smith, Mar. Resour. Res. Inst., Charleston, SC, pers. commun. 1983).

The following sections outline current methodologies involved in shrimp mariculture in the United States as of late 1983. Topics include species of importance and life cycles, maturation/reproduction methodology, hatchery/nursery systems, and growout systems.

### SPECIES OF IMPORTANCE AND LIFE CYCLES

---

There are three commercially important penaeids in U.S. coastal waters from the southeastern Atlantic states bordering the Atlantic Ocean around the Florida peninsula into and throughout the Gulf of Mexico. These are *Penaeus aztecus*, or brown shrimp; *Penaeus duorarum*, or pink shrimp; and *Penaeus setiferus*, or white shrimp (Lawrence et al. 1983a). *P. aztecus* and *P. duorarum* are both grooved shrimps with closed thelyca, i.e., they have a pair of mid-dorsal, lateral grooves extending from the rostrum to the rear of the carapace. *P. setiferus* does not have these grooves and is referred to as a non-grooved shrimp with open thelyca.

Spawning takes place in open waters 30-200 m deep. Nauplius larvae hatch within 12-24 hours. There are five or six nauplius stages during which no food is consumed. The last nauplius molts into a protozoa larva after 2-3 days. Protozoa feed primarily on algae (diatoms and phytoflagellates) and secondarily on small zooplankters during a 3.5-5.0 day period in which they undergo three molts, the last giving rise to the mysis stage. Mysis larvae feed primarily on zooplankters, but do consume algae. There are three mysis stages with the final molt giving rise to the postlarval stage. Postlarvae feed on animal material and detritus. They are demersal, in contrast to earlier stages that are planktonic, and are identified by the number of days elapsed since they became postlarvae: PL<sub>1</sub>, PL<sub>5</sub>, PL<sub>40</sub>, etc.

During larval development, the planktonic shrimp are carried into coastal estuaries by tides and other currents and arrive as postlarvae or small juveniles. After a period of about 60-100 days, juveniles reach a size of 5-15 g and begin to migrate from estuaries to open waters. They are demersal during the day but rise to the surface at night and move outward on the outgoing tide.

The grooved shrimps typically spawn in late winter and early spring, with juveniles returning to open water in late spring and into the summer. The non-grooved shrimps primarily spawn in late to early summer, and postlarvae enter estuaries as the juvenile grooved shrimps leave them. Non-grooved shrimps return to open water during late summer and into the fall. There is always some degree of niche overlap, but not enough to prevent coexistence of all species. *P. duorarum* tends to favor sandy substrates, while *P.*

*aztecus* favors mud and is more abundant in the northern Gulf of Mexico where mud substrates predominate. Life history studies of the various species include: *P. setiferus* (Lindner and Anderson 1956; Lindner and Cook 1970; Chamberlain and Lawrence 1983; Renfro and Brusher 1982); *P. duorarum* (Costello and Allen 1970; Renfro and Brusher 1982); and *P. aztecus* (Cook and Lindner 1970; Renfro and Brusher 1982; Chamberlain and Lawrence 1983).

None of the three native penaeids has shown great promise as a culture species in North America; of the three, however, *P. setiferus* is generally considered the best performer (Broom 1968; Latapie et al. 1972; Neal and Latapie 1972; Parker 1972; Parker and Holcomb 1973; Hysmith and Colura 1976). Because culturists have obtained less production in ponds with the native species, they have experimented with a number of exotic species. Two non-grooved species, *Penaeus stylirostris* and *Penaeus vannamei*, are especially favored at this time. Both perform better than indigenous species (Parker et al. 1974; Conte 1978; Trimble 1980; Ojeda et al. 1980). *P. vannamei* performs best in pond situations, but seed cannot yet be produced on a completely reliable basis (Chamberlain et al. 1980; Lawrence et al. 1983a). The one commercial operation in Texas had good results with *P. vannamei* in 1983, while the Texas A&M University research station is studying both species. Texas A&M is also evaluating *P. monodon*, the most utilized shrimp in pond production in southeast Asia, and two native species, *P. setiferus* and *P. aztecus*. The University of Arizona's Hawaiian work is emphasizing *P. stylirostris*.

### MATURATION/REPRODUCTION METHODOLOGY

---

An abundant, reliable, and inexpensive source of seedstock is an absolute necessity for shrimp mariculture. This realization has historically led farmers toward reduced dependence on wild populations. Originally seedstock (postlarvae and juveniles) were obtained directly from the wild (Lunz 1951, 1956; Broom 1968; Parker and Holcomb 1973). Subsequently, mature, mated females were captured from the wild and spawned in captivity (Wheeler 1967; Gould et al. 1973; Hysmith and Colura 1976). At present, shrimp are reared to adult size, then matured and spawned in captivity, completing the life cycle independent of wild populations. This experimental maturation and reproduction technology is now being evaluated to develop a commercial level of frequency and predictability.

The ovaries of all penaeid shrimps extend dorsally far into the abdomen from the cephalothorax (Heinen 1976; Chamberlain and Lawrence 1983). Although ovarian maturation is a continual, gradual process, mariculturists have developed a series of maturation stages to assist in selecting ripe spawners. Female grooved shrimps have closed thelyca and mate shortly after the molt preceding spawning. They store the sperm, and culturists depend on the ovarian stage to determine if a female will spawn during a particular evening (all shrimp invariably spawn at night). Female non-grooved shrimps have open thelyca and spawn shortly after mating. Males deposit spermatophores, and a sperm mass remains in the thelycum after the spermatophore becomes detached if mating was successful. Normally, only open-thelycum females with advanced ovarian development mate. Culturists examine such females carefully after the early evening mating period to determine if spermatophores or sperm masses are present. Development of artificial insemination technology (see below) is helping greatly to eliminate much of the uncertainty about mating status of female non-grooved shrimps.

Maturation with spawning of marine shrimp in captivity was first reported by Hudinaga (1942) using the temperate closed-thelycum shrimp *Penaeus japonicus*. Moore et al. (1974) reported limited maturation/reproduction in raceways using the closed-thelycum shrimp *P. californiensis*. Duronslet et al. (1975) reported induced egg growth in the closed-thelycum shrimp *Penaeus aztecus*, in raceways for both unablated and unilaterally eyestalk-ablated animals. Maturation without spawning, and spawning without viable zygotes, were reported for *P. setiferus* and *P. stylirostris* (open-thelycum shrimp), respectively, in 0.1-ha hypersaline ponds (Conte 1975; Conte et al. 1977). The first real success in maturation and reproduction in captivity was reported by Aquacop (1975) for *P. merguensis*, *P. japonicus*, *P. aztecus*, and *Metapenaeus ensis* in tanks. Several reports indicate that the following species require unilateral or bilateral eyestalk ablation for ovarian maturation: *P. aztecus* (Aquacop 1975), *P. duorarum* (Idyll 1971; Caillouet 1972), *P. kerathurus* (Lumare 1979), *P. monodon* (Aquacop 1975, 1977a, b; Santiago 1977; Primavera 1978; Primavera and Borlongan 1978), and *P. orientalis* (Arnstein and Beard 1975). Maturation with spawning of viable zygotes has been achieved with unblated *P. japonicus* in tanks using particular light intensities, photoperiods, and nutritional supplementation (Laubier-Bonichon and Laubier 1979; Laubier-Bonichon 1978; Caubere et al. 1979). Aquacop (1975) reported less ovarian maturation of *P. merguensis* in a tank receiving 40% incident light vs. one receiving 10%. In addition, Chamberlain and Lawrence (1981b) reported that optimum light intensity for *P. stylirostris* appears to be lower than for *P. vannamei*, with natural light supplementation beneficially affecting reproduction of both species. Less stringent photoperiods and light intensities with diets containing at least some frozen natural foods have been used to obtain spawning with viable nauplii in tanks for unablated *P. japonicus*, *P. merguensis*, *P. monodon*, *P. setiferus*, *P. stylirostris*, and *P. vannamei* (Aquacop 1975; Beard et al. 1977; Primavera et al. 1978; Brown et al. 1980; Lawrence et al. 1980; Chamberlain and Lawrence 1981a, b). However, with all of these species except *P. japonicus*, unilateral eyestalk ablation enhanced maturation and spawning with viable nauplii (Aquacop 1975, Beard et al. 1977; Primavera et al. 1978; Brown et al. 1980; Lawrence et al. 1980; Chamberlain and Lawrence 1981a, b). Furthermore, species such as *P. indicus* and *P. stylirostris* (Mexican strain), which have been matured in captivity without ablation (Aquacop 1979; Emmerson 1980a), are annually ablated to increase spawning rates. Recently, Chamberlain and Lawrence (1981b) suggested that male gonadal development may be a limiting factor in reproduction of marine shrimp in captivity, as they obtained increased reproduction of *P. vannamei* by unilateral eyestalk ablation of males. Another factor is deterioration of sperm quality in shrimp held in captivity (Trujillo and Lawrence in press).

Unfortunately, several investigators have obtained data indicating that unilaterally eyestalk-ablated, captive-reared shrimp have lower fecundity and hatching rates than unablated wild shrimp (Nurjana and Yang 1976; Lumare 1979; Emmerson 1980a; Primavera and Posadas 1980, 1981). Furthermore, ablated penaeids often are limited to short periods of viable spawning before they must be replaced with new brookstock (Aquacop 1979; Beard and Wickins 1980).

The nutritional requirements for penaeid shrimp maturation and reproduction are poorly understood, even though nutrition is one of the most important factors in maturation. Several investigators use only combinations of animal food sources, such as bivalves, cephalopods, crustaceans, fish, and polychaetes, for penaeid shrimp reproduction in captivity (Arnstein and Beard 1975; Beard et al.

1977; Santiago 1977; Brown et al. 1979; Kelemec and Smith 1980; Beard and Wickins 1980; Chamberlain and Lawrence et al. 1981a, b). Chamberlain and Lawrence (1981a) concluded that a combination of animal sources (squid, shrimp, polychaetes, and clams) is better than a single-food diet. However, some researchers have obtained maturation and reproduction of penaeid shrimp in captivity using single-food diets, such as fish (Lichatowich et al. 1978), mussels (Laubier-Bonichon and Laubier 1979; Primavera et al. 1978; Lumare 1979), mysid shrimp (Alikuhni et al. 1975; Nurjana and Yang 1976), and squid (Chamberlain and Lawrence 1981a). Other researchers have fed a combination of prepared dried feeds and frozen or fresh animals (Aquacop 1975, 1979; Primavera et al. 1978; Emmerson 1980a; Lawrence et al. 1980). We are not aware of any published information indicating that maturation/reproduction of penaeid shrimp in captivity can be obtained using only prepared dried feed.

The ability to artificially inseminate shrimp was reported by Peryn (1977), who patented a method for artificial insemination of open-thelycum *Penaeus* species. This technique involves mechanically removing the spermatophore, isolating the sperm mass, and placing the sperm mass in the thelycum area of a gravid female. Intraspecific—but not interspecific—crosses, using a similar technique, have been successful for several species of *Macrobrachium* (Sandifer and Smith 1979). Sandifer and Lynn (1981), using similar techniques, successfully obtained interspecific crosses of two *Penaeus* species. These crosses were obtained with male *P. stylirostris* and female *P. setiferus* and with male *P. setiferus* and male *P. stylirostris*. *P. setiferus* is native to the Gulf of Mexico, and *P. stylirostris* is native to the Pacific Ocean from Peru to Mexico. Sandifer et al. (1984) obtained successful intraspecific crosses with *P. vannamei* and *P. stylirostris* by artificial insemination. Bray et al. (1982, 1983) not only successfully obtained viable offspring of *P. setiferus* using artificial insemination, but also increased the production of nauplii from sourcing cruises by 300%. This removes some of the unpredictability of obtaining nauplii of open-thelycum penaeids from sourcing cruises because only 11% to 50% of mature *P. setiferus* females are mated (Burkenroad 1939; Eldred 1958). Using artificial insemination, sourcing cruises could be an economically feasible means of supplementing the production of nauplii from maturation and reproduction in captivity for supplying seedstock for commercial shrimp mariculture. Also, the successful interspecific crosses provide the basis for initiation of genetic selection studies. Finally, artificial insemination will help solve the problems of lack of mating and spermatophore loss in captivity, and provide the basis for studies concerned with the quality of sperm and ova. Some initial success also has been obtained on cryopreserving shrimp nauplii, but not zygotes, protozoa, or mysis (Lawrence and Baust 1980). Successful cryopreservation of shrimp gametes, zygotes, or larvae would potentially decrease the cost of seedstock produced in captivity and their transportation.

## HATCHERY/NURSERY SYSTEMS

---

There are basically two hatchery systems: the extensive, or Japanese, method using green water and large tanks; and the intensive, or Galveston, method using clear water and small tanks (Mock and Neal 1974; Heinen 1976). In the Japanese method, gravid females are stocked in large tanks where dense algal populations have been established. These algae provide feed for the protozoal stage. Postlarvae can be held in tanks for 10 days or so postmetamorphosis. Only newly hatched nauplii are stocked in the Galveston method.

Gravid females are allowed to spawn individually in relatively small containers. Protozoa are fed living or frozen algal suspensions produced separately from the hatchery system itself. Postlarvae are normally transferred at an earlier age, 5-7 days postmetamorphosis, than they would be in the Japanese system. Merits and demerits of these two methods are discussed later; however, the intensive (Galveston) method, in some form, is preferred to the extensive (Japanese) method by shrimp culturists in the United States.

Since the pioneering work of Hudinaga in 1942, considerable progress has been made in the field of larval rearing (Hudinaga and Kittaka 1967; Cook 1967; Cook and Murphy 1966, 1969; Mock 1971; Shigueno 1972, 1975; Tabb et al. 1972; Yang 1975; Heinen 1976; Mock et al. 1980a, b). A disturbing feature of current larval rearing data is the tremendous variability in performance of the larvae, as expressed in terms of survival from the nauplius to the postlarval stage. For example, in some recent reports of rearing attempts with several penaeid species of commercial interest, survival range was 5-44% for *Penaeus japonicus* (Hudinaga and Miyamura 1962; Hudinaga and Kittaka 1967; Shigueno 1975), 1-100% for *Penaeus monodon* (Liao and Huang 1972; Platon 1978; Beard and Wickins 1980), and 0-77% for *Penaeus stylirostris* (Mock et al. 1980a, b; J. S. Wilkenfeld, Texas A&M Univ., Port Aransas, TX, unpubl. data 1983). The potential problem this variability presents for commercial operations is accentuated by the inability of various researchers to duplicate their own results consistently (Cook and Murphy 1969; Shigueno 1969; Brown 1972; Liao and Huang 1972; Mock et al. 1980b). The major factors contributing to inconsistent postlarval production are nauplii quality, water quality, experimental conditions (physical and environmental), and feeding regimes.

The effect of differences in quality of larvae batches on the results of larval rearing efforts has been noted by a number of researchers (Hudinaga 1942; Brown 1972; Wickins 1972; Mock and Neal 1974; Beard et al. 1977; Cognie and Hirata 1978; Aquacop 1980; Wilkenfeld et al. 1984; Kuban et al. 1984). These variations may be due to individual differences between spawning females, whether the females were obtained from the wild or matured in captivity, how long the captive female had been in a "production" mode, the diet fed to maturation stock, and the physical and hormonal manipulations performed on broodstock animals to bring them to a reproductive state.

A number of methods are suggested in the literature for identifying "good" batches of eggs (Hudinaga and Miyamura 1962; Mock and Neal 1974; Yang 1975; Aquacop 1977a; Platon 1978; Primavera and Posadas 1980) and nauplii (Hudinaga 1942; Yang 1975; Aquacop 1977a; Cognie and Hirata 1978; Emmerson 1980a; Mock et al. 1980a). However, all these methods are subjective and, thus, dependent on the experience and interpretation of the hatchery technician, and less desirable than a concise test which would give hatchery personnel the ability to consistently select nauplii batches of good, or at least uniform, quality.

Sufficient information is currently available to establish desirable water quality parameters for penaeid larval culture (Hudinaga 1942; Cook and Murphy 1966, 1969; Cook 1967; Mock et al. 1974; Shigueno 1975; Wickins 1976; Lawrence et al. 1981c; Castille and Lawrence 1981). Fluctuations of incoming seawater quality can, however, have significant effects on the results of rearing efforts (Cook and Murphy 1966; Shigueno 1969; Mock 1971). This suggests that the selection of a synthetic media mix, at least for use in small-scale bioassay systems, would significantly enhance the reproducibility of results. A small-scale system (one L volume) using a synthetic sea salt media has recently been reported (Wilkenfeld et al. 1983).

Interpretation and comparison of available shrimp research data are difficult, and sometimes impossible, because of major differences in experimental techniques and systems used by various research groups (Mock 1971; Zein-Eldin and Meyers 1973; Yang 1975; New 1976; Emmerson and Andrews 1981). Experimental systems for larval culture recorded in the literature include assorted glass beakers from 250 to 4000 mL in volume (Hudinaga 1942; Cook and Murphy 1966; Brown 1972; Gopalakrishnan 1976; Beard and Wickins 1980), inverted glass carboys of 19 L volume (Cook 1967; Mock and Murphy 1970; Wilkenfeld et al. 1981), medium size tanks of 50-500 L volume (Cook and Murphy 1966; Beard et al. 1977; Beard and Wickins 1980; Emmerson and Andrews 1981), and large-scale tanks ranging from 1,000 to 200,000 L (Hudinaga and Kittaka 1967; Cook and Murphy 1969; Salser and Mock 1974; Brown 1972; Tabb et al. 1972; Shigueno 1975; Heinen 1976; Mock et al. 1980a, b).

Various feeding regimes are mentioned in many of the papers dealing with rearing of penaeid shrimp larvae. For the most part, however, the pattern established by Hudinaga (1942) of feeding protozoa with phytoplankton, and mysis with phytoplankton supplemented with zooplankton, has persisted.

A number of different genera of diatoms and phytoflagellates have been used repeatedly with some measure of success, among them *Chaetoceros* (Hirata et al. 1975; Yang 1975; Millamena and Aujero 1978; Platon 1978; Simon 1978; Jones et al. 1979a), *Isochrysis* (Millamena and Aujero 1978; Samocha 1980; Wilkenfeld et al. 1981), *Nitzschia* (Hudinaga and Miyamura 1962; Liao and Huang 1972; Wickens 1976), *Phaeodactylum* (Tabb et al. 1972; Wickins 1976; Samocha 1980), *Skeletonema* (Hudinaga 1942; Hudinaga and Miyamura 1962; Hudinaga and Kittaka 1966; Cook and Murphy 1969; Brown 1972; Liao and Huang 1972; Mock and Neal 1974; Wickins 1976; Mock et al. 1980a), *Tetraselmis* (Mock and Neal 1974; Beard et al. 1977; Millamena and Aujero 1978; Platon 1978; Wickins and Beard 1978; Mock et al. 1980a; Samocha 1980; Wilkenfeld et al. 1981) and *Thalassiosira* (Cook 1967; Cook and Murphy 1969; Brown 1972; Wickins 1976; Emmerson 1980b).

Despite the large number of studies concerned with algal feeding regimes, there are few data concerning identification of a single algal species or combination of species which would be significantly better than any other for rearing larval penaeid shrimp. Data presented by Kuban et al. (1984) and Wilkenfeld et al. (1984) suggest that the diatom combination of *Skeletonema costatum* and *Chaetoceros gracilis* is superior to the phytoflagellate combination of *Isochrysis* sp. and *Tetraselmis chuii* as a nutritional source for penaeid larvae (*P. stylirostris*, *P. vannamei*, *P. setiferus*, and *P. aztecus*). In another study, Thomas et al. (1976) found that *Metapeneaus affinis* larvae metamorphosed to the postlarval stage quicker when fed *Thalassiosira* sp. rather than *Tetraselmis gracilis*. Continued studies to identify optimum algal species of species combination and optimum feeding densities will, no doubt, lead to improved production capacity in hatcheries.

The need for an animal protein source as a component of the mysis stage diet was first recognized by Hudinaga (1942). Since that time, a number of live and frozen animal food sources (bivalve eggs and veliger larvae, small zooplankton, penaeid nauplii, ground fish, rotifers, and brine shrimp nauplii) have been used successfully during the mysis substages (Hudinaga 1942; Cook and Murphy 1969; Liao and Huang 1972; Kittaka 1975; Yang 1975; Heinen 1976; Mock et al. 1980a; Wilkenfeld et al. 1981). However, the brine shrimp *Artemia* has consistently been the food of choice as an animal protein source because of its ease of use and ready acceptability



by many larval aquatic organisms including shrimp (Reeve 1969; Tabb et al. 1972; Wickins 1972; Salser and Mock 1974; Kittaka 1975; Yang 1975; Sorgeloos 1979, 1980; Johns et al. 1980; Mock et al. 1980b).

The major drawbacks to the use of *Artemia* are the high price and occasional unavailability of the cysts (Hudinaga and Miyamura 1962; Benijuts et al. 1975; Sorgeloos 1979, 1980). There is a need for less expensive, more readily available, animal protein source that can be used as a partial or complete substitute for *Artemia* in the mysis and early postlarval diets.

A number of experiments have already been performed in which the rotifer *Brachionus plicatilis* was fed to either the protozoa or mysis stage of penaeid shrimp with varying degrees of success (Hudinaga and Kittaka 1966; Kittaka 1975; Yang 1975; Platon 1978; Al-Attar and Ikenoue 1979; Emmerson 1980b; Fontaine and Revera 1980; Mock et al. 1980a). Despite the recognized potential advantage of rotifers as a food organism for larval shrimp (small size, slow moving, easily digested, potential replacement for *Artemia*) (Al-Attar and Ikenoue 1979; Fontaine and Revera 1980; Mock et al. 1980a), there is not yet sufficient information available to demonstrate at what larval substages and at what densities rotifers can be advantageously fed, and to what extent they can be successfully substituted for *Artemia*.

The nematode *Panagrellus redivivus* is another animal protein source which has recently shown some promise as a potential substitute for *Artemia* (Fontaine et al. 1981; Wilkenfeld et al. 1984). In the above reports, *P. redivivus* were consumed by late protozoal and mysis larvae, though sufficient survival and growth data are not yet available to draw firm conclusions about their nutritional value. Preliminary indications are that the lipid content of *P. redivivus* compares favorably with that of freshly hatched *Artemia* nauplii (about 24% on a dry weight basis) (Benijuts et al. 1975). Penaeids and other crustacean larvae are known to require lipid content in their diet (Jones et al. 1979a, b; Emmerson 1980b), and thus research into the potential use of *P. redivivus* as an animal protein source is of particular importance.

Recently, several studies have shown that the food value of rotifers and *Artemia* can be affected by the nutrient source used to rear the larval food organism itself (Wickins 1972; Scott and Middleton 1979; Kitajima et al. 1979; Watanabe et al. 1979; Al-Khars et al. 1980). The concept of improving the nutrient value of live larval foods through media manipulation is of great importance, and rotifers in particular, because of their size and method of feeding, are an excellent model organism for testing this approach. A few experiments have already been performed in which the food value of *Brachionus plicatilis* was modified in order to improve performance of fish larvae fed upon them (Kitajima et al. 1979, 1980).

Fontaine and Revera (1980) suggested a similar approach to be used with rotifers fed to penaeid larvae. They described a simple technique for causing *B. plicatilis* to gorge themselves on the desired food organism, appropriately terming the process "biological micro-encapsulation". Subsequent biochemical analysis indicated very significant nutritional changes (e.g., lipid) in the fed rotifers (Lawrence and Middleton, unpubl.). Further research using rotifers as carriers for selected food particles should contribute significantly to our knowledge of the nutritional requirements of larval penaeid shrimp.

It is clear from the literature cited thus far that current larval feeding regimes are almost totally dependent on the use of living foods. These living foods, particularly algae, require highly technical culture procedures.

Two basic approaches for culturing live larval foods have been

taken (Mock and Neal 1974; Heinen 1976). In the Japanese (or extensive) system of larval rearing, mixed phytoplankton and zooplankton blooms are developed in the hatchery tank by fertilization of the seawater prior to metamorphosis of the nauplii to the protozoa stage (Shigueno 1975; Yang 1975). In the Galveston (or intensive) system, shrimp and feed organisms are cultured separately, and feeding is carried out only as needed, depending on residual food remaining in the tank and the developmental stage of the larvae (Mock and Murphy 1970; Salser and Mock 1974; Mock and Neal 1974; Wilkenfeld et al. 1984).

Heinen (1976) succinctly described the advantages and disadvantages of each system as follows: "Current indoor (intensive) methods . . . use greater larval densities, require less space and water, and offer more reliability; outdoor (extensive) methods are simpler, offer lower labor costs, require no separate algal culture, and are much less dependent on use of *Artemia* . . .". Both methods are dependent on critically timed blooms or hatches, and suffer from the potentially catastrophic hazard posed by failed or collapsed food organisms cultures (Shigueno 1975; Simon 1978). In addition, the Galveston method of algae culture would not be practical in terms of the manpower and space that would be required to produce sufficient quantities to be fed live in a large-scale commercial facility (Hidu and Ukeles 1962).

Feeding frozen larval foods is an alternative that reduces the burden and risks of dependence on continuous culture of live larval food organisms (Brown 1972). The earliest attempt at feeding frozen foods was reported by Hudinaga and Kittaka (1966) using oyster eggs. Results were generally poor, and this was attributed to either deteriorating water quality as a result of food breakdown in the tank, or breakdown of the frozen food in storage.

More recent findings on the use of frozen foods for larval shrimp rearing show greater promise (Brown 1972; Mock and Neal 1974; Salser and Mock 1974; Millamena et al. 1977; Lawrence et al. 1978; Millamena and Aujero 1978; Baust and Lawrence 1979; 1980a; Mock et al. 1980a, b; Wilkenfeld et al. 1981). Frozen foods, when used, have improved the reliability of supply, but in general are not considered to be as good as the living organisms (Hudinaga and Kittaka 1966; Kittaka 1975; Heinen 1976; Sorgeloos 1980). Better cryopreservation techniques for larval foods must be developed in order to overcome the problems of reduced nutritional value and deteriorating water quality, which can deleteriously affect the production capabilities of larval rearing facilities (Hudinaga and Kittaka 1966; Kittaka 1975; Fluchter 1980; Mock et al. 1980b; Baust and Lawrence 1980b, c; Wilkenfeld et al. 1981).

## GROWOUT SYSTEMS—PONDS

Many studies have been conducted on pond culture of shrimp. In the United States, shrimp mariculture research in ponds was initiated by Lunz using *Penaeus aztecus*, *P. duorarum*, and *P. setiferus* (Lunz 1951, 1956, 1958, 1967; Lunz and Bearden 1963). He demonstrated that ponds in which flooding was accomplished by tidal flow, or which were built on higher land with water supplied by irrigation pumps, were suitable for growing shrimp for both bait and food. Using Purina Catfish Chow, Broom (1968) obtained 530 to 909 kg/ha (472 and 809 lbs/acre) and food conversion ratios of 2.3:1 and 3.0:1 in ponds for *P. aztecus* and *P. setiferus*, respectively. Latapie et al. (1972) and Neal and Latapie (1972), also conducting research in ponds at Grand Terre, Louisiana, obtained 933 kg/ha (831 lbs/acre) and food conversion ratios as low as 1.1:1. Each of these last three papers concluded that *P. setiferus* grew

faster and had higher survival than *P. aztecus*. This was also the conclusion of Parker (1972), Parker and Holcomb (1973), and Hysmith and Colura (1976) for *P. setiferus* and *P. aztecus* in ponds on the upper Texas Gulf Coast. Wheeler (1967, 1968) demonstrated that the addition of inorganic fertilizer to ponds at Galveston enhanced the growth of *P. aztecus* by increasing natural productivity. Quick and Morris (1976) postulated that the increased growth of brown shrimp (*P. aztecus*) in ponds containing dredged materials was due to greater natural productivity as compared to ponds without dredged material. More recently *P. stylirostris* have been grown in ponds with natural productivity enhanced by the mixing of secondarily treated sewage with seawater (Landau et al. 1982).

Lunz and Bearden (1963), Broom (1970), Parker et al. (1972), Conte (1975), and Rose et al. (1975) concluded that certain fish were a source of predation and competition for shrimp and should be removed from shrimp ponds. Gould et al. (1973) obtained production as great as 596 kg/ha using the brown shrimp *P. aztecus*, and concluded that failure to control predation and competition would markedly reduce yields in ponds. In 1974, Parker et al. produced 1,234 kg/ha of 61 count (heads-on) *P. vannamei* using a 3-unit (nursery, intermediate, and growout) pond system. These shrimp had a value of more than \$5,500/ha. They also reported that *P. vannamei* was better in terms of pond production than *P. setiferus*, which in turn was better than *P. aztecus* and *P. occidentalis*. Elam and Green (1974) produced 224 and 667.5 kg/ha with food conversion rates of 1.8 and 2.3, respectively, using *P. setiferus* in ponds located in the middle Texas coast. More recently, more than 2,200 kg/ha of 41 count (heads-on) of *P. vannamei* were obtained in single pond units in four months (Chamberlain et al. 1981). These shrimp had a value of over \$4,500/ha using ex-vessel prices. Investigators also have reported that polyculture of such diverse species as fish and shrimp increases the productivity of ponds (Gundermann and Popper 1977; Liao and Huang 1972; Rossberg and Strawn 1980; Tatum and Trimble 1978; Trimble 1980). Furthermore, George (1975) observed that *Metapenaeus dobsoni* and *P. indicus* performed better than *M. monoceros* and *M. affinis* in controlled polyculture experiments. The polyculture of two very closely related penaeid species, *P. vannamei* and *P. stylirostris*, in ponds resulted in an increase in gross revenue over that of either species when monocultured (Chamberlain et al. 1981). The staggered stocking concept was tested by Ojeda et al. (1980), and their results indicated that ponds stocked in three increments over time had better survival and gave higher yields than those expected from single-stocked ponds at the same density.

Food is a major cost item in the operation of a shrimp farm (Parker and Hayenga 1979; Adams et al. 1980; Farmer 1981; Pardy et al. 1983). Although "suitable feeds" are available for pond culture, there is considerable room for improvement. Marine shrimp are omnivores and detrital feeders (Williams 1955; Dall 1968; Caillouet et al. 1972, 1976; Cuzon et al. 1974; Venkataramiah et al. 1975, 1978; Moriarty 1976, 1977; Jacob et al. 1980) and with the help of bacteria, even utilize dissolved organic matter (Lawrence et al. 1975; Castille and Lawrence 1979). In contrast, Marter (1980) concluded that *P. monodon* is more of a predator for slow-moving benthic macroinvertebrates than a scavenger of detritivore. However, there is no doubt that natural productivity in ponds is of considerable nutritional importance to shrimp. In fact, after analysis of stomach contents of *Metapenaeus macleayi*, Maguire and Bell (1981) concluded that 42% of the shrimp diet came from natural productivity even though the shrimp were being fed 5% of their biomass each day with a formulated feed. Also indicating the importance of natural productivity to shrimp in ponds, Latapie et al. (1972) and Rubright

et al. (1981) obtained 47 to 300 kg/ha and 245 kg/ha, respectively, in ponds not receiving any fertilizer or feed. By adding organic fertilizer to ponds Caillouet et al. (1972, 1976) reported 180 to 401 kg of shrimp/ha. Quick and Morris (1976) and Rubright et al. (1981) obtained 250 kg/ha and 375 to 590 kg/ha of shrimp, respectively, by adding inorganic fertilizer to ponds. The addition of fertilizer increases natural productivity (Stahl 1979; Boyd et al. 1981; Geiger 1981; Rubright et al. 1981) resulting in increased production of the cultured animal (e.g., shrimp).

Preliminary economic analysis of pond production for shrimp where the growing season is less than one year (e.g., Texas) has indicated that greater than 600 kg/ha per crop are needed to support a commercial operation (Parker and Hayenga 1979; Adams et al. 1980; Griffin et al. 1981; Pardy et al. 1983). Natural productivity is not adequate to support the stocking densities necessary to consistently achieve production rates greater than 600 kg/ha. Broom (1970) stated that shrimp production in ponds not fertilized and fed seldom exceeds 224 kg/ha and that yields are much higher in ponds receiving feed. Therefore, in most studies of shrimp pond production, fertilizer and formulated feed are added to the ponds (Neal and Latapie 1972; Gould et al. 1973; Parker et al. 1974; Hysmith and Colura 1976; Chamberlain et al. 1981; Maguire and Bell 1981; Rubright et al. 1981; Maguire and Hume 1982).

Surprisingly, very few studies are concerned with developing an adequate feed for pond production of shrimp. Broom (1972) concluded that shrimp fed 26-30%, as compared with 60%, dietary protein grew well in ponds. Parker and Holcomb (1973) evaluated shrimp production in ponds for two feeds, each containing 50% protein; in one feed, 60% of the protein was derived from fish meal; in the other, only 20% was from fish meal. They also tested a 35% protein diet prepared by Ralston Purina. No differences in production were reported for these different diets. Aquacop (1977b) found that a diet of approximately 40% protein gave excellent growth for *P. monodon* (3-25 g in 133 days). SEAFDEC tested this same diet and obtained 25 g *P. monodon* from 3 g animals in 7 months (Cook and Rabinal 1978). Excellent results have also been obtained with a 36.58% protein feed made in Taiwan by the President Company (Cook and Rabinal 1978). In the study by Chamberlain et al. (1981), more than 2,200 kg/ha were produced using a Ralston Purina feed which was analyzed to contain approximately 20% protein. A 25% protein commercial feed from Texas Farm Products tested with *P. vannamei* and *P. setiferus* produced growth of 1-2 g per animal per week in ponds (Lawrence and Johns, unpubl.). Maguire and Hume (1982) obtained data suggesting that a 27% protein feed is satisfactory for shrimp in ponds.

## INTENSIVE GROWOUT SYSTEMS

Intensive growout systems concentrate shrimp in a small area. Circulation and aeration are increased to remove wastes and oxygenate the water. Both open (once-through) and closed (recirculation) systems have been developed. While these systems have been biologically successful, none has been commercially successful to date. However, the open system developed originally by the Universities of Arizona and Sonora (Mexico), with industrial sponsorship, is said to be perfected to the point that commercial development will soon proceed at a Hawaiian site (D. V. Lightner, Environ. Res. Lab., Univ. Arizona, Tucson, AZ 85706, pers. commun. 1983).

A brief description of the Arizona/Sonora system is in order. Growout units are called "aquacells," with representative dimen-

sions of  $3.35 \times 61 \times 0.3$  m. Each unit typically contains two long raceways covered with air-inflated plastic domes. Sea water from wells is delivered through side manifolds and is turned over seven times a day. Water remains clear and shrimp remain visible.

The hatchery phase of this intensive system takes roughly 20 days (Galveston method), the post-hatchery nursery phase some 18 weeks, and the final growout phase 21 weeks. After this 220-230 day period, shrimp are harvested at a large size of 21 g. Final carrying capacity is 5.6 kg/m<sup>2</sup>. Based on 1980 data, 18 growout units could produce 3,632 kg of shrimp per month. Pertinent references include Mahler et al. (1974) and Salser et al. (1978).

## CONCLUSIONS

Penaeid shrimps are high value, glamorous crustaceans. They are being cultured commercially in Central and South America, Southeast Asia, and Japan, where climatic, biologic, and economic conditions, and availability of excellent native shrimp for stocking ponds, favored development of shrimp culture before the necessary technology was perfected in the United States. However, it appears that where suitable sites are available, penaeid shrimps can be cultured profitably in extensive semi-intensive and intensive pond systems, and intensive raceway systems. We are optimistic that continued demand and high prices for penaeid shrimps, with continued development of technology, should lead to the development of a commercial shrimp mariculture industry in the United States.

## CITATIONS

- ADAMS, C. M., W. L. GRIFFIN, J. P. NICHOLS, and R. W. BRICK.  
1980. Bio-engineering economic model for shrimp mariculture system, 1979 Tex. A&M Univ. Sea Grant Coll. TAMU-SG-80-203, 125 p.
- AL-ATTAR, M. H., and H. IKENOUE.  
1979. The production of juvenile shrimps (*Penaeus semisulcatus*) for release off the coast of Kuwait during 1975. Kuwait Bull. Mar. Sci. 1:1-31.
- AL-KHARS, A. M., S. M. KAMEL, and T. KAWANO.  
1980. Mass production of rotifer, *Brachionus plicatilis*, by using yeasts. Part 2—Outdoor culture. Prepared for Symposium on Coastal Aquaculture, Jan. 12-18, 1980, Cochin, India, 23 p.
- ALIKUHNI, K. H., A. POERNOMO, S. ADISUKRESONO, M. BUDIONO, and S. BUSMAN.  
1975. Preliminary observations on induction maturing and spawning in *Penaeus monodon* Fabricius and *Penaeus merguensis* de Man by eyestalk extirpation. Bull. Shrimp Cult. Res. Cent. 1:1-11.
- ANONYMOUS.  
1983. Status of shrimp culture in the Western Hemisphere, Aquaculture Digest (San Diego, CA) 8(12):1-13.  
1984. High-tech prawn farm being planned. *The Straits Times* (Singapore), Dec. 21, 1984.
- AQUACOP.  
1975. Maturation and spawning in captivity of penaeid shrimp: *Penaeus merguensis* de Man, *Penaeus japonicus* Bates, *Penaeus aztecus* Ives, *Metapenaeus ensis* de Hann, and *Penaeus semisulcatus* de Hann. Proc. World Maricult. Soc. 6:123-132.  
1977a. Observations on the maturation and reproduction of penaeid shrimp in captivity in a tropical medium. Third meeting, I.C.E.S. Working Group on Mariculture, May 10-13, 1977, Brest, France. Actes Colloq. CNEXO, 4.  
1977b. Reproduction in captivity and growth of *Penaeus monodon*, Fabricius in Polynesia. Proc. World Maricult. Soc. 8:927-945.  
1979. Penaeid reared broodstock: closing the cycle of *P. monodon*, *P. stylirostris*, and *P. vannamei*. Proc. World Maricult. Soc. 10:445-452.  
1980. Penaeid reared broodstock: closing the cycle of *P. monodon*, *P. stylirostris* and *P. vannamei*. Cent. Oceanolog. Pacifique, CNEXO-COP, Tahiti, 12 p.
- ARNSTEIN, D. R., and T. W. BEARD.  
1975. Induced maturation of prawn *Penaeus orientalis* Kishinouye in the laboratory by means of eyestalk removal. Aquaculture 5:411-412.
- BAUST, J. G., and A. L. LAWRENCE.  
1979. Enhancement of chill tolerance in larval *Artemia salina*: cooling regimes and multiple type cryoprotectant exposure. Proc. World Maricult. Soc. 10:421-428.  
1980a. Freezing tolerance in larval *Artemia*. In G. Persoone et al. (eds.), The brine shrimp *Artemia*, Vol. 2, p. 115-122. Universa Press, Wetteren, Belgium, 664 p.  
1980b. Ontogenetic variability of chill tolerance in larval *Artemia salina*. I. Single cryoprotectants. Aquaculture 20:305-311.  
1980c. Ontogenetic variability of chill tolerance in larval *Artemia salina*. II. Dual cryoprotectants. Aquaculture 20:313-321.
- BEARD, T. W., and J. F. WICKINS.  
1980. Breeding of *Penaeus monodon* Fabricius in laboratory recirculation systems. Aquaculture. 20:79-89.
- BEARD, T. W., J. F. WICKINS, and D. R. ARNSTEIN.  
1977. The breeding and growth of *Penaeus merguensis* de Man in laboratory recirculating systems. Aquaculture 10:275-289.
- BENJUTS, F., E. VANVOORDE, and P. SORGELOOS.  
1975. Changes in the biochemical composition of the early larval stages of the brine shrimp, *Artemia salina* L. In 10th European Symposium on Marine Biology, Sept. 17-23, Ostend, Belgium. Vol. 1:1-9.
- BOYD, C. E., Y. MUSIG, and L. TUCKER.  
1981. Effects of three phosphorus fertilizers on phosphorus concentrations and phytoplankton production. Aquaculture 22:175-180.
- BRAY, W. A., G. W. CHAMBERLAIN, and A. L. LAWRENCE.  
1982. Increased larval production of *Penaeus setiferus* by artificial insemination during sourcing cruises. J. World Maricult. Soc. 13:123-133.
- BRAY, W. A., A. L. LAWRENCE, and G. W. CHAMBERLAIN.  
1983. Observations on natural and artificial insemination of *Penaeus setiferus*. Crustaceana (Leiden) 1:392-405.
- BROOM, J. G.  
1968. Pond culture of shrimp on Grand Terre Island, Louisiana, 1962-1968. Proc. Gulf Caribb. Fish. Inst. 21:137-151.  
1970. Shrimp culture. Proc. World Maricult. Soc. 1:63-68.  
1972. Shrimp studies in Honduras 1969-1971. Proc. World Maricult. Soc. 3:193-204.
- BROWN, A.  
1972. Experimental techniques for preserving diatoms used as food for larval *Penaeus aztecus*. Proc. Natl. Shellfish. Assoc. 62:21-25.
- BROWN, AL, J. McVEY, B. S. MIDDLEDITCH, and A. L. LAWRENCE.  
1979. The maturation of the white shrimp (*Penaeus setiferus*) in captivity. Proc. World Maricult. Soc. 10:435-444.
- BROWN, A., J. McVEY, B. M. SCOTT, T. D. WILLIAMS, B. S. MIDDLEDITCH, and A. L. LAWRENCE.  
1980. The maturation and spawning of *Penaeus stylirostris* under controlled laboratory conditions. Proc. World Maricult. Soc. 11:488-499.
- BURKENROAD, M. D.  
1939. Further observations on Penaeidae of the northern Gulf of Mexico. Bull. Bingham Oceanogr. Collect. Yale Univ. 6:1-62.
- CAILLOUET, C. W., Jr.  
1972. Ovarian maturation induced by eyestalk ablation in pink shrimp, *Penaeus duorarum* Burkenroad. Proc. World Maricult. Soc. 3:205-225.
- CAILLOUET, C. W., Jr., J. M. HEINEN, and D. C. TABB.  
1972. Pink shrimp feeding experiments with wheat bran. Proc. World Maricult. Soc. 3:415-465.
- CAILLOUET, C. W., Jr., J. P. NORRIS, E. J. HEALD, and D. C. TABB.  
1976. Growth and yield of pink shrimp (*Penaeus duorarum*) in feeding experiments in concrete tanks. Trans. Am. Fish. Soc. 105:259-266.
- CASTILLE, F. L., Jr., and A. L. LAWRENCE.  
1979. The role of bacteria in the uptake of hexoses from sea water by postlarval penaeid shrimp. Comp. Biochem. Physiol. 64A:41-48.  
1981. The effects of EDTA (ethylenedinitro tetraacetic acid) on the survival and development of shrimp nauplii (*Penaeus stylirostris* Stimpson) and the interactions of EDTA with toxicities of cadmium, calcium and phenol. J. World Maricult. Soc. 12:(2):292-304.
- CAUBERE, J. L., R. LAFON, R. RENE, and C. SALES.  
1979. Étude de la maturation et la ponte chez *Penaeus japonicus* en captivité. In T. V. R. Pillay and W. A. Dill (eds.), Advances in aquaculture, p. 277-284. Fishing News Books Ltd., Surrey.
- CHAMBERLAIN, G. W., D. L. HUTCHINS, A. L. LAWRENCE, and J. C. PARKER.  
1980. Winter culture of *Penaeus vannamei* in ponds receiving thermal effluent at different rates. Proc. World Maricult. Soc. 11:30-43.

- CHAMBERLAIN, G. W., D. L. HUTCHINS, and A. L. LAWRENCE.  
1981. Mono and polyculture of *Penaeus vannamei* and *Penaeus stylirostris*. J. World Maricult. Soc. 12(1):251-270.
- CHAMBERLAIN, G. W., and A. L. LAWRENCE.  
1981a. Maturation, reproduction, and growth of *Penaeus vannamei* and *P. stylirostris* fed different diets. J. World Maricult. Soc. 12:209-244.  
1981b. Effect of light intensity and male and female eyestalk ablation on reproduction of *Penaeus stylirostris* and *Penaeus vannamei*. J. World Maricult. Soc. 12(2):357-372.  
1983. Reproductive activity and biochemical composition of *Penaeus setiferus* and *Penaeus aztecus* in the Gulf of Mexico. Tex. A&M Univ. Sea Grant Coll. TAMU-SG-84-203, 35 p.
- COGNIE, D., and T. HIRATA.  
1978. Élevage larvaire de penaeids a l'échelle pilote. Cent. Natl. Exploit. Océans Rapp., Base Oceanol. Mediterr., 14 p.
- CONTE, F. S.  
1975. Penaeid shrimp culture and the utilization of waste head effluent. Proc., Waste Head Aquaculture Workshop 1:27-47.  
1978. Penaeid shrimp culture current status and direction of research. In P. N. Kaul and C. J. Sindermann (eds.), Drugs and food from the sea, p. 333-343. Univ. Oklahoma Press, Norman, OK.
- CONTE, F. S., M. J. DURONSLET, W. J. CLARK, and J. C. PARKER.  
1977. Maturation of *Penaeus stylirostris* (Stimpson) and *P. setiferus* (Linn.) in hypersaline water near Corpus Christi, Texas. Proc. World Maricult. Soc. 8: 327-334.
- COOK, H. L.  
1967. A method of rearing penaeid shrimp for experimental studies. FAO Fish. Rep. 57, Vol. 3:709-715.
- COOK, H. L., and M. J. LINDNER.  
1970. Synopsis of biological data on the brown shrimp *Penaeus aztecus aztecus* Ives, 1981. FAO Fish. Rep. 57, Vol. 4:1471-1497.
- COOK, H. L., and M. A. MURPHY.  
1966. Rearing penaeid shrimp from eggs to postlarvae. Proc., Annual Conference of the Southeastern Association Game and Fish Commissioners 19: 283-388.  
1969. The culture of larval penaeid shrimp. Trans. Am. Fish. Soc. 98:751-754.
- COOK, H. L., and H. R. RABINAL.  
1978. Manual on pond culture of penaeid shrimp. ASEAN Natl. Coord. Agency of the Philippines, 132 p.
- COSTELLO, T. J., and D. M. ALLEN.  
1970. Synopsis of biological data on the pink shrimp *Penaeus duorarum duorarum* Burkenroad, 1939. FAO Fish. Rep. 57, Vol. 4:1499-1537.
- CUZON, G., H. J. CECCALDI, and D. COGNIE.  
1974. Essais de nutrition de *Palaemon serratus* a l'aide d'aliments composés. Tethys 6:799-804.
- DALL, W.  
1968. Food and feeding of some Australian penaeid shrimp. FAO Fish. Rep. 2:251-258.
- DAVIS, S., and M. A. JOHNS.  
1984. The effect of stocking density on the growth of postlarval and nursery reared *Penaeus vannamei*. Annu. Meet., World Maricult. Soc., Abstracts: 19.
- de la BRETONNE, L. W., Jr., and J. W. AVAULT, Jr.  
1970. Shrimp mariculture methods tested. Am. Fish Farmer 1(12):8-11 & 27.
- DURONSLET, M. M., A. I. YUDIN, R. S. WHEELER, and W. H. CLARK, Jr.  
1975. Light and fine structural studies of natural and artificially induced egg growth of penaeid shrimp. Proc. World Maricult. Soc. 6:105-122.
- ELAM, L. L., and A. W. GREEN.  
1974. Culture of white shrimp (*Penaeus setiferus*, Linnaeus) in static water ponds. Proc. World Maricult. Soc. 5:87-96.
- ELDRED, B.  
1958. Observations on the structural development of the genitalia and the impregnation of the pink shrimp *Penaeus duorarum* Burkenroad. Fla. Board Conserv. Mar. Res. Lab. Tech. Ser. 23:1-26.
- EMMERSON, W. D.  
1980a. Induced maturation of prawn *Penaeus indicus*. Mar. Ecol. Prog. Ser. 2:121-131.  
1980b. Ingestion, growth and development of *Penaeus indicus* larvae as a function of *Thalassiosira weissflogii* cell concentration. Mar. Biol. (Berl.) 58:65-73.
- EMMERSON, W. D., and B. ANDREWS.  
1981. The effect of stocking density on the growth, development and survival of *Penaeus indicus* Milne Edwards larvae. Aquaculture 23:45-57.
- FARMER, A. S. D.  
1981. Prospects for penaeid shrimp culture in arid lands. In Farmer, A. S. D. (ed.), Advances in food producing systems for arid and semi arid lands. Acad. Press, New York, 1019 p.
- FLUCHTER, J.  
1980. Review of the present knowledge of rearing whitefish (Coregonidae) larvae. Aquaculture 19:191-208.
- FONTAINE, C. T., and D. B. REVERA.  
1980. The mass culture of the rotifer, *Brachionus plicatilis*, for use as foodstuff in aquaculture. Proc. World Maricult. Soc. 11:211-218.
- FONTAINE, C. T., D. B. REVERA, H. M. MORALES, and C. R. MOCK.  
1981. Preliminary observations and procedures for the mass culture of the nematode, *Panagrellus redivivus* for use as foodstuff in penaeid shrimp hatcheries. Spec. Publ., Galveston Lab., Natl. Mar. Fish. Serv., NOAA, Galveston, TX.
- GEIGER, J. L.  
1981. A brief synopsis on zooplankton composition and dynamics in striped bass rearing ponds. U.S. Fish. Wildl. Serv., Southeast. Fish Cultural Lab, Marion, Alabama, 15 p.
- GEORGE, M. J.  
1975. Observations on the growth in certain penaeid prawns studied in prawn culture experiments in paddy field. Bull. Mar. Sci. Univ. Cochín 7:41-55.
- GOPALAKRISHNAN, K.  
1976. Larval rearing of red shrimp *Penaeus merginatus* (Crustacea). Aquaculture 9:145-154.
- GOULD, R. A., D. V. ALDRICH, and C. R. MOCK.  
1973. Experimental pond culture of brown shrimp (*Penaeus aztecus*) in power plant effluent water. Proc. World Maricult. Soc. 4:195-213.
- GRIFFIN, W. L., J. S. HANSON, R. W. BRICK, and M. A. JOHNS.  
1981. Bioeconomic modeling with stochastic elements in shrimp culture. J. World Maricult. Soc. 12:94-193.
- GÜNDERMANN, N., and D. POPPER.  
1977. A comparative study of three species of penaeid prawns and their suitability for polyculture with fish in the Fiji Islands. Aquaculture 11:63-71.
- HANSON, J. A., and H. L. GOODWIN.  
1977. Shrimp and prawn farming in the Western Hemisphere. Dowden, Hutchinson & Ross, Inc., Stroudsburg, PA, 439 p.
- HEINEN, J. M.  
1976. An introduction to culture methods for larval and postlarval shrimp. Proc. World Maricult. Soc. 7:333-344.
- HIDU, H., and R. UKELES.  
1962. Dried unicellular algae as food for larvae of the hard shell clam, *Mercenaria mercenaria*. Proc. Natl. Shellfish. Assoc. 53:85-101.
- HIRATA, H., Y. MORI, and M. WATANABE.  
1975. Rearing of prawn larvae, *Penaeus japonicus*, fed soy-cake particles and diatoms. Mar. Biol. (Berl.) 29:9-13.
- HIRONO, Y.  
1983. Preliminary report on shrimp culture activities in Ecuador. J. World Maricult. Soc. 14:451-457.
- HUDINAGA, M.  
1942. Reproduction, development and rearing of *Penaeus japonicus* Bate. Jpn. J. Zool. 10:305-393.
- HUDINAGA, M., and J. KITTAKA.  
1966. Studies on food and growth of larval stage of a prawn, *Penaeus japonicus*, with reference to the application to practical mass culture (in Japanese). Inf. Bull. Planktol. Jpn. 13:83-94.  
1967. The large scale production of the young kurama prawn, *Penaeus japonicus* Bate. Inf. Bull. Planktol. Jpn, Commemoration Number of Dr. Y. Matsue, p. 35-46.
- HUDINAGA, M., and M. MIYAMURA.  
1962. Breeding of the Kurama prawn, (*Penaeus japonicus* Bate). J. Oceanogr. Soc. Jpn. 20:696-706.
- HYSMITH, B. T., and R. L. COLURA.  
1976. Effect of salinity on growth and survival of penaeid shrimp in ponds. Proc. World Maricult. Soc. 7:389-403.
- IDYLL, C. P.  
1971. Induced maturation of ovaries and ova in pink shrimp. Commer. Fish. Rev. 33:20.
- JACOB, P. G., M. A. ZARBA, and V. ANDERLINI.  
1980. Biochemical and related features of benthic mud of Kuwaiti waters. Indian J. Mar. Sci. 9:100-105.
- JOHNS, D. M., M. E. PETERS, and A. D. BECK.  
1980. International Study on *Artemia* IV. Nutritional value of geographical and temporal strains of *Artemia*: Effects on survival and growth of two species of Brachyuran larvae. In Persoone, G., et al. (eds.), The brine shrimp *Artemia*, Vol. 3, p. 290-304. Universa Press, Wetteren, Belgium.
- JOHNS, M. A., and S. DAVIS.  
1984. Size distribution in penaeid shrimp from mariculture ponds and its effect on economic return. Annu. Meet., World Maricult. Soc., Abstracts: 39.

- JONES, D. A., A. KANAZAWA, and S. ABDEL RAHMAN.  
1979a. Studies on the presentation of artificial diets of rearing the larvae of *Penaeus japonicus* Bate. *Aquaculture* 17:33-43.
- JONES, D. A., A. KANAZAWA, and K. ONO.  
1979b. Studies on the nutritional requirements of the larval stages of *Penaeus japonicus* using microencapsulated diets. *Mar. Biol.* 54:261-267.
- KELEMEC, J. A., and I. R. SMITH.  
1980. Induced ovarian development and spawning of *Penaeus plebejus* in a recirculating laboratory tank after unilateral eyestalk enucleation. *Aquaculture* 21:55-62.
- KITAJIMA, C., S. FUJITA, F. OHWA, Y. YONE, and T. WATANABE.  
1979. Improvement of dietary value for red sea bream larvae of rotifers *Brachionus plicatilis* cultured with baker's yeast *Saccaromyces cerevisiae*. *Bull. Jpn. Soc. Sci. Fish.* 45:469-471.
- KITAJIMA, C., M. YOSHIDA, and T. WATANABE.  
1980. Dietary value for Ayu *Plecoglossus altivelis* of rotifer *Brachionus plicatilis* cultured with baker's yeast *Saccaromyces cerevisiae* supplemented with cuttlefish liver oil. *Bull. Jpn. Soc. Sci. Fish.* 46:47-50.
- KITAKA, J.  
1975. Food and growth of penaeid shrimp. In Price, K. S., Jr., et al. (eds.), *Proc. First Int. Conf. on Aquaculture Nutrition*, p. 249-385. University of Delaware, Newark.
- KUBAN, F. D., J. S. WILKENFELD, and A. L. LAWRENCE.  
1984. Survival, metamorphosis and growth of four larval penaeid shrimp species fed six food combinations. *Aquaculture* 47:151-162.
- LANDAU, M., R. H. PIERCE, J. H. RYTHER, and J. A. ZEIGLER.  
1982. The quality of shrimp reared in a sewage/seawater aquaculture system. *Am. Zool.* 22:912.
- LATAPIE, W. R., Jr., J. G. BROOM, and R. A. NEAL.  
1972. Growth rates of *Penaeus aztecus* and *P. setiferus* in artificial ponds under varying conditions. *Proc. World Maricult. Soc.* 3:241-254.
- LAUBIER-BONICHON, A.  
1978. Ecophysiologie de la reproduction chez la crevette *Penaeus japonicus* trois années d'expérience en milieu contrôlé. *Oceanol. Acta* 1:135-150.
- LAUBIER-BONICHON, A., and L. LAUBIER.  
1979. Reproduction contrôlée chez la crevette *Penaeus japonicus*. In Pillay, T. V. R., and W. A. Dill (eds.), *Advances in aquaculture*, p. 273-277. Fishing News Books Ltd., Surrey.
- LAWRENCE, A. L., E. CHAN, and G. SCHULTE.  
1975. The role of bacteria in the uptake and utilization of dissolved organics by immature oysters and shrimp. In 10th European Symposium on Marine Biology, Ostend, Belgium. Abstracts, Topic 2.
- LAWRENCE, A. L., J. G. BAUST, and G. CONDON.  
1978. Enhancement of chill tolerance in larval *Artemia salina*. II. Two phase cryoprotectant exposure. *Cryobiology* 15:682.
- LAWRENCE, A. L., Y. AKAMINE, B. S. MIDDLEDITCH, G. CHAMERLAIN, and D. HUTCHINS.  
1980. Maturation and reproduction of *Penaeus setiferus* in captivity. *Proc. World Maricult. Soc.* 11:481-487.
- LAWRENCE, A. L., and J. G. BAUST.  
1980. Viability of penaeid shrimp larvae frozen to -16°C using different cooling procedures. *Cryobiology* 17:622.
- LAWRENCE, A. L., G. W. CHAMBERLAIN, and D. L. HUTCHINS.  
1981a. Shrimp mariculture; an overview. *Tex. A&M Univ. Sea Grant Coll. TAMU-SG-82-503*, 9 p.  
1981b. Shrimp mariculture, general information and commercial status. *Proc. Annu. Trop. Subtrop. Fish. Technol. Conf. of the Americas* 6:20-24.
- LAWRENCE, A. L., J. M. FOX, and F. L. CASTILLE, Jr.  
1981c. Decreased toxicity of divalent cations to shrimp nauplii (*Penaeus stylirostris*) in the presence of EDTA. *J. World Maricult. Soc.* 12(1):271-280.
- LAWRENCE, A. L., M. A. JOHNS, and W. L. GRIFFIN.  
1983a. Shrimp mariculture: Positive aspects and state of the art. In Honziak, J., and J. Lutz (eds.), *Proc., Aquaculture in Dredge Material Containment Areas*, p. 55-78. U.S. Army Corps of Engineers, Wash., D.C., 216 p.  
1983b. Shrimp mariculture: State of the art. *Tex. A&M Univ. Sea Grant Coll. TAMU-SG-84-502*, 12 p.
- LAWRENCE, A. L., J. P. McVEY, M. A. JOHNS, and W. L. GRIFFIN.  
1983c. Production of two shrimp crops per year in south Texas using a single phase pond production system. *Crustaceana (Leiden)* 1:91-98.
- LAWRENCE, A. L., L. T. LESTER, and W. A. BRAY.  
1984. Successful interspecific cross between *Penaeus setiferus* and *P. stylirostris* using artificial insemination. *Annu. Meet., World Maricult. Soc., Abstracts*: 38.
- LIAO, I. C., and T. L. HUANG.  
1972. Experiments on the propagation and culture of prawns in Taiwan. In Pily, T. V. R. (ed.), *Coastal aquaculture in the Indo-Pacific region*, p. 328-354. Fishing News (Books) Ltd., Surrey, 497 p.
- LICHATOWICH, T., T. SMALLEY, and F. D. MATE.  
1978. The natural reproduction of *Penaeus merguensis* (de Man. 1888) in an earthen pond in Fiji. *Aquaculture* 15:377-378.
- LINDNER, M. J., and W. W. ANDERSON.  
1956. Growth, migrations, spawning and size distribution of shrimp *Penaeus setiferus*. U.S. Fish Wildl. Serv. Fish. Bull. 56:553-645.
- LINDNER, M. J., and H. L. COOK.  
1970. Synopsis of biological data on the white shrimp *Penaeus setiferus* (Linnaeus 1767). *FAO Fish. Rep.* 57, Vol. 4:1439-1469.
- LUMARE, F.  
1979. Reproduction of *Penaeus kerathurus* using eyestalk ablation. *Aquaculture* 18:203-214.
- LUNZ, G. R.  
1951. A saltwater fish pond. *Contrib. Bears Bluff Lab.* 12:1-12.  
1956. Harvest from an experimental one-acre saltwater pond at Bears Bluff Laboratories, South Carolina. *Prog. Fish-Cult.* 19:92-94.  
1958. Pond cultivation of shrimp in South Carolina. *Proc. Gulf Caribb. Fish. Inst.* 10:44-48.  
1967. Farming the salt marshes. *Proc., Marsh and Estuary Management Symp., Louisiana State Univ. Press* 1:172-177.
- LUNZ, G. R., and C. M. BEARDEN.  
1963. Control of predacious fishes in shrimp farming in South Carolina. *Contrib. Bears Bluff Lab.* 36:96
- MAGUIRE, G. B., and J. D. BELL.  
1981. The effects of fish on growth and survival of school prawns *Metapenaeus macleayi* (Haswell) in some Australian brackish water farming ponds. *Aquaculture* 24:267-283.
- MAGUIRE, G. G., and I. D. HUME.  
1982. A study of the nutritional requirement of school prawns *Metapenaeus macleayi* (Haswell) in some Australian brackish water farming ponds. *Aquaculture* 29:261-278.
- MAHLER, L. E., J. E. GROH, and C. N. HODGES.  
1974. Controlled-environment aquaculture. *Proc. World Maricult. Soc.* 5:379-384.
- MARTER, C. L.  
1980. The food and feeding habit of *Penaeus monodon* Fabricius collected from Makato River, Aklan, Philippines (Decapoda, Natantia). *Crustaceana* 38: 225-236.
- MILLAMENA, O., and E. J. AUJERO.  
1978. Preserved algae as food for *Penaeus monodon* larvae. *SEAFDEC Q. Res. Rep.* 2:15-16.
- MILLAMENA, O. M., E. C. JEREOS, and I. R. GORRICETA.  
1977. Methods of harvesting and preservation of the diatom *Chaetoceros calcitrans*. *SEAFDEC Q. Res. Rep.* 1:3-8.
- MOCK, C. R.  
1971. Larval culture of penaeid shrimp at the Galveston Biological Laboratory. *Contrib. 344, Galveston Lab., Natl. Mar. Fish. Serv., NOAA, Galveston, TX* p. 33-40.
- MOCK, C. R., and M. A. MURPHY.  
1970. Techniques for raising penaeid shrimp from egg to postlarvae. *Proc. World Maricult. Soc.* 1:143-156.
- MOCK, C. R., and R. A. NEAL.  
1974. Penaeid shrimp hatchery systems. *Proc., FAO CARPAS Symposium on Aquaculture*, Nov. 26-Dec. 2, Montevideo, Uruguay, 9 p.
- MOCK, C. R., L. A. ROSS, and B. R. SALSER.  
1974. Design and preliminary evaluation of a closed system for shrimp culture. *Proc. World Maricult. Soc.* 8:335-369.
- MOCK C. R., C. T. FONTAINE, and D. B. REVERA.  
1980a. Improvements in rearing larval penaeid shrimp by the Galveston Laboratory method. In Persoone, G., et al. (eds.), *The brine shrimp Artemia*, Vol. 3, p. 331-342. Universa Press, Wetteren, Belgium.
- MOCK, C. R., D. B. REVERA, and C. T. FONTAINE.  
1980b. Larval culture of *Penaeus stylirostris* using modifications of the Galveston Laboratory technique. *Proc. World Maricult. Soc.* 11:102-117.
- MOORE, D. W., R. W. SHERRY, and F. MONTANEZ.  
1974. Maturation of *Penaeus californiensis* in captivity. *Proc. World Maricult. Soc.* 5:445-450.
- MORIARTY, D. J. W.  
1976. Quantitative studies on bacteria and algae in the food of the mullet *Mugil cephalus* and the prawn *Metapenaeus bennettiae* (Race and Dal). *J. Exp. Mar. Biol. Ecol.* 22:131-143.  
1977. Quantification of carbon, nitrogen and bacterial biomass in the food of some penaeid prawns. *Aust. J. Mar. Freshwater Res.* 28:113-118.
- NEAL, R. A., and W. R. LATAPIE, Jr.  
1972. Pond culture on Grand Terre Island, Louisiana, 1969-1971. *Proc. World Maricult. Soc.* 3:227-240.

- NEW, M. B.  
1976. A review of dietary studies with shrimp and prawns. *Aquaculture* 9:101-144.
- NURJANA, M. L., and W. T. YANG.  
1976. Induced gonad maturation, spawning, and postlarval production of *Penaeus merguensis* de Man. *Bull. Shrimp Cult. Res. Cent.* 11(1&2):177-186.
- OJEDA, J. W., D. V. ALDRICH, and K. STRAWN.  
1980. Staggered stocking of *Penaeus stylirostris* in brackish water ponds receiving power plant cooling water. *Proc. World Maricult. Soc.* 11:23-29.
- PARDY, C. R., W. L. GRIFFIN, M. A. JOHNS, and A. L. LAWRENCE.  
1983. A preliminary economic analysis of stocking strategies for penaeid shrimp culture. *J. World Maricult. Soc.* 14:49-63.
- PARKER, J. C.  
1972. Commercial shrimp nearing reality. *Tex. Agric. Prog.* 18:13-16.
- PARKER, J. C., H. W. HOLCOMB, Jr., W. G. KLUSMAN, and J. C. McNEIL, IV.  
1972. Effects of fish removal on the growth and condition of white shrimp, *Penaeus setiferus* (Linnaeus), in brackish ponds. *Proc. World Maricult. Soc.* 3:287-297.
- PARKER, J. C., and H. W. HOLCOMB, Jr.  
1973. Growth and production of brown and white shrimp (*Penaeus aztecus* and *P. setiferus*) from experimental ponds in Brazoria and Orange counties, Texas. *Proc. World Maricult. Soc.* 4:215-234.
- PARKER, J. C., F. S. CONTE, W. S. MacGRATH, and B. W. MILLER.  
1974. An intensive culture system for penaeid shrimp. *Proc. World Maricult. Soc.* 5:65-79.
- PARKER, J. C., and W. A. HAYENGA.  
1979. An analysis of the investment considerations for penaeid shrimp mariculture in pond systems. Laguna Madre Plantation Systems, Port Isabel, TX. (unpubl. manuscript.)
- PERSYN, H. O.  
1977. Artificial insemination of shrimp. U.S. Patent 4,031,855, June 28, 1977, 4 p.
- PLATON, R. R.  
1978. Design, operation and economics of a small-scale hatchery for the larval rearing of sugpo, *Penaeus monodon* Fabricius. SEAFDEC Aquacult. Ext. Manual 1, 30 p.
- PRIMAVERA, J. H.  
1978. Induced maturation and spawning in five-month old *Penaeus monodon* Fabricius by eyestalk ablation. *Aquaculture* 13:355-359.
- PRIMAVERA, J. H., and E. BORLONGAN.  
1978. Ovarian rematuration of ablated sugpo prawn *Penaeus monodon* Fabricius spawners by eyestalk ablation. *Fish. Res. J. Philipp.* 3:1-12.
- PRIMAVERA, J. H., E. BORLONGAN, and R. A. POSADAS.  
1978. Mass production in concrete tanks of sugpo *Penaeus monodon* Fabricius spawners by eyestalk ablation. *Fish. Res. J. Philipp.* 3:1-12.
- PRIMAVERA, J. H., and R. A. POSADAS.  
1980. Studies on the egg quality of *Penaeus monodon* Fabricius based on morphology and hatching rates. *Contrib. 70, Aquaculture Dep. Southeast Asian Fish. Dev. Cent.*, Iloilo City, Philippines, 18 p.  
1981. Studies on the egg quality of *Penaeus monodon* Fabricius, based on morphology and hatching rates. *Aquaculture* 22:269-277.
- QUICK, J. A., Jr., and J. A. MORRIS.  
1976. Experimental extensive culture of penaeid shrimp in a simulated dredged material disposal area. *Proc. World Maricult. Soc.* 7:305-326.
- REEVE, M. R.  
1969. The laboratory culture of the prawn *Palaemon serratus*. *Fish. Invest. Lond., Ser. 2*, 26(1), 38 p.
- RENFRO, W. C., and H. A. BRUSHER.  
1982. Seasonal abundance, size distribution, and spawning of three shrimps (*Penaeus aztecus*, *P. setiferus*, and *P. duorarum*) in the northwestern Gulf of Mexico, 1961-62. NOAA Tech. Memo. NMFS-SEFC-94, SE Fish. Cent., Natl. Mar. Fish. Serv., NOAA, 24 p.
- ROSE, C. D., A. H. HARRIS, and B. WILSON.  
1975. Extensive culture of penaeid shrimp in Louisiana salt-marsh impoundments. *Trans. Am. Fish. Soc.* 104:246-307.
- ROSSBERG, K. S., and R. K. STRAWN.  
1980. Comparative growth and survival of brown shrimp cultured with Florida pompano, black drum and striped mullet. *Proc. World Maricult. Soc.* 11:219-225.
- RUBRIGHT, J. S., J. L. HARRELL, H. W. HOLCOMB, and J. C. PARKER.  
1981. Responses of planktonic and benthic communities to fertilizer and feed applications in shrimp mariculture. *J. World Maricult. Soc.* 12:281-299.
- SALSER, B. R., and C. R. MOCK.  
1974. Equipment used for the culture of larval penaeid shrimp at the National Marine Fisheries Service Galveston Laboratory. *In Proc., Fifth Congreso Nacional de Oceanographia, Guaymas*, p. 22-25.
- SALSER, B. R., L. MAHLER, D. LIGHTNER, J. URE, D. DANALD, C. BRAND, N. STAMP, D. MOORE, and B. COLVIN.  
1978. Controlled environment aquaculture of penaeids. *In P. N. Kaul and C. J. Sinderman* (eds.), *Drugs and food from the sea*, p. 345-355. Univ. Oklahoma Press, Norman, OK.
- SAMOCHA, T. M.  
1980. Developmental aspects of *Penaeus semisulcatus* de Haan, 1844 (Crustacea: Decapoda) under laboratory and pond conditions. Ph.D. thesis, Tel-Aviv Univ., Israel, 250 p.
- SANDIFER, P. A., and J. W. LYNN.  
1981. Artificial insemination of caridean shrimp. *In Clark, W. H., Jr., and T. S. Adams* (eds.), *Recent advances in invertebrate reproduction*, p. 271-288. Elsevier/North-Holland, New York.
- SANDIFER, P. A., and T. I. J. SMITH.  
1979. A method for artificial insemination of *Macrobrachium* prawns and its potential use in inheritance and hybridization studies. *Proc. World Maricult. Soc.* 10:403-418.
- SANDIFER, P. A., A. L. LAWRENCE, S. G. HARRIS, G. W. CHAMBERLAIN, A. D. STOKES, and W. A. BRAY.  
1984. Electrical stimulation of spermatophore expulsion in marine shrimp, *Penaeus* spp. *Aquaculture* 41:181-187.
- SANTIAGO, A. C., Jr.  
1977. Successful spawning of cultured *Penaeus monodon* after eyestalk ablation. *Aquaculture* 11:185-196.
- SCOTT, A. P., and C. MIDDLETON.  
1979. Unicellular algae as a food for turbot (*Scophthalmus maximus* O.) larvae—the importance of dietary long-chain polyunsaturated fatty acids. *Aquaculture* 18:227-240.
- SHIGUENO, K.  
1969. Problems in prawn culture in Japan. *Suisan Zoshoku Soshu*, 19. Nihon Suisan Shigen Hogo Kyokai, Tokyo. p. 1-93. [Translated for U.S. Dep. Commer., Natl. Tech. Information Serv., TT 74-52032]  
1972. Problems of prawn culture in Japan. *Overseas Tech. Coop. Agency Publ.*, 37 p.  
1975. Shrimp culture in Japan. *Assoc. for Int. Tech. Promotion, Tokyo, Japan*, 153 p.
- SIMON, C. M.  
1978. The culture of the diatom *Chaetoceros gracilis* and its use as a food for penaeid protozoal larvae. *Aquaculture* 14:105-113.
- SMITH, L.  
1984. Growth of *Penaeus vannamei* and *P. setiferus* in brackishwater artesian-fed ponds in south Texas. *Annu. Meet., World Maricult. Soc.*, Abstracts: 39.
- SORGELOOS, P.  
1979. The brine shrimp, *Artemia salina*: A bottleneck in mariculture. *In Pillay, T. V. R., and W. A. Dill* (eds.), *FAO Tech. Conf. on Aquaculture, Kyoto*, p. 321-324. Fishing News Books Ltd., Farnham, 653 p.  
1980. The use of the brine shrimp *Artemia* in aquaculture. *In Persoone, G., et al.* (eds.), *The brine shrimp Artemia*, Vol. 3, p. 25-46. Universa Press, Wetteren, Belgium.
- STAHL, M. S.  
1979. The role of natural productivity and applied feeds in the growth of *Macrobrachium rosenbergii*. *Proc. World Maricult. Soc.* 10:92-109.
- TABB, D. C., W. T. YANG, Y. HORONO, and J. HEINEN.  
1972. A manual for culture of pink shrimp *Penaeus duorarum* from eggs to postlarvae suitable for stocking. *Univ. Miami, Sea Grant Spec. Bull.* 7, 55 p.
- TATUM, W. M., and W. C. TRIMBLE.  
1978. Monoculture and polyculture pond studies with pompano (*Trachinotus carolinus*) and penaeid shrimp (*Penaeus aztecus*, *P. duorarum*, and *P. setiferus*). *Proc. World Maricult. Soc.* 9:433-446.
- THOMAS, M. M., M. KATHIRVEL, and N. N. PILLAI.  
1976. Spawning and rearing of the penaeid prawn, *Metapenaeus affinis* (H. Milne Edwards) in the laboratory. *Indian J. Fish.* 21(2):543-556.
- TRIMBLE, W. C.  
1980. Production trials for monoculture and polyculture of white shrimp (*Penaeus vannamei*) or blue shrimp (*P. stylirostris*) with Florida pompano (*Trachinotus carolinus*) in Alabama, 1978-79. *Proc. World Maricult. Soc.* 11:44-59.
- TRUJILLO, J. R., and A. L. LAWRENCE.  
*In press.* Observations of decline in male viability of *Penaeus setiferus* under laboratory conditions. *Aquaculture*.
- VENKATARAMIAH, A., G. J. LAKSHMI, and G. GUNTER.  
1975. Effect of protein level and vegetable matter on growth and food conversion efficiency of brown shrimp. *Aquaculture* 6:115-125.
- VENKATARAMIAH, A., D. W. COOK, P. BIESIOT, and G. J. LAKSHMI.  
1978. Nutritional value of high marsh grass and shrimp shell waste for

- commercial brown shrimp (*Penaeus aztecus* Ives). Proc. World Maricult. Soc. 9:217-224.
- WATANABE, T., F. OOWA, C. KITAJIMA, S. FUJITA, and Y. YONE.  
1979. Relationship between the dietary value of rotifers *Brachionus plicatilis* and their content of W-3 highly unsaturated fatty acids. Bull. Jpn. Soc. Sci. Fish. 45:883-889.
- WHEELER, R. S.  
1967. Experimental rearing of postlarval brown shrimp to a marketable size in ponds. Commer. Fish. Rev. 29:459-52.  
1968. Culture of penaeid shrimp in brackish-water ponds, 1966-67. Proc. 23d Annu. Conf. Southeast. Assoc. Game Fish Commun., 5 p.
- WICKINS, J. F.  
1972. The food value of brine shrimp, *Artemia salina* L., to larvae of the prawn, *Palaemon serratus* Pennant. J. Exp. Mar. Biol. Ecol. 10:151-170.  
1976. Prawn biology and culture. Oceanogr. Mar. Biol. Annu. Rev. 17:435-507.
- WILKENFELD, J. S., J. M. FOX, and A. L. LAWRENCE.  
1981. Consumption of frozen and live *Artemia* by protozoa of *Penaeus setiferus*. Proc. World Maricult. Soc. 12(2):250-259.
- WILKENFELD, J. S., A. L. LAWRENCE, and F. D. KUBAN.  
1983. A reliable small scale experimental system for rearing penaeid shrimp larvae in a synthetic sea salt medium. Crustaceana (Leiden) 1:72-81.  
1984. Survival, metamorphosis and growth of penaeid shrimp larvae reared on a variety of algae and animal foods. J. World Maricult. Soc. 15:31-49.
- WILLIAMS, A. B.  
1955. A contribution to the life histories of commercial shrimps (Penaeidae) in North Carolina. Bull. Mar. Sci. Gulf Caribb. 5:116-147.
- YANG, W. T.  
1975. A manual for large-tank culture of penaeid shrimp to the postlarval stages. Bull. 31, 94 p. Univ. Miami Sea Grant Tech.
- ZEIN-ELDIN, Z., and S. P. MEYERS.  
1973. General consideration of problems in shrimp nutrition. Proc. World Maricult. Soc. 4:299-317.





# Development of Larval Rearing Systems for the Malaysian Prawn *Macrobrachium rosenbergii* in Southern Louisiana

STEPHEN W. CANGE  
DAVID L. PAVEL  
MARK S. LAMON  
JAMES W. AVAULT, JR.

*School of Forestry, Wildlife, and Fisheries  
Louisiana Agricultural Experiment Station  
Louisiana State University Agricultural Center  
Baton Rouge, Louisiana 70803*

## ABSTRACT

Prawn (*Macrobrachium rosenbergii*) culture research has been conducted in Louisiana during the past six years by the Louisiana Agricultural Experiment Station (LAES) and the Louisiana Department of Wildlife and Fisheries. Most of the research thus far has been conducted in replicated earthen ponds, where investigators have compared prawn feeds, stocking sizes, stocking densities, polyculture strategies, and rotation schemes. However, high costs and difficulty in obtaining postlarval prawns for pond stocking have led to recent development of larval rearing systems at the LAES. Rearing system designs and initial results are discussed in this paper.

## INTRODUCTION

Experimental culture of the Malaysian prawn *Macrobrachium rosenbergii* has been conducted in Louisiana during the past 6 years by the Louisiana Agricultural Experiment Station (LAES) and the Louisiana Department of Wildlife and Fisheries. At least 120 experimental ponds have been stocked with prawns since 1979 (Table 1).

Pond culture experiments have involved studies with prawn feeds (Perry and Tarver 1981, in press), stocking sizes (Pavel et al. 1985), stocking densities (Cange et al. 1983), polyculture with finfish (Huner et al. 1980; Miltner et al. 1983), and rotation with crawfish, *Procambarus clarkii* and *Procambarus acutus acutus* (Cange et al. in press). These studies have shown significant increases in yield with supplemental feeding and increased stocking size; an inverse linear relationship between stocking density and prawn size at harvest; compatible polyculture with catfish (*Ictalurus punctatus*), tilapia (*Oreochromis aureas*), chinese carps (*Hypophthalmichthys molitrix* and *Ctenopharyngodon idella*), and golden shiners (*Notemigonus crysoleucas*); and successful rotation with crawfish. Results indicate good pond culture potential for prawns in southern Louisiana. However, the availability and cost of seed stock for pond stocking has greatly restricted development of pond culture efforts.

Postlarval prawns utilized for our initial growout studies were purchased from commercial hatcheries in Hawaii and Florida. Hatchery prices ranged from 2 to 3¢/postlarva plus air freight to Louisiana (total cost 4-5¢/postlarva). We had no control over the condition or quality of purchased postlarvae. Typically, many postlarvae were dead, injured, or under stress after hours in air transit. Moreover, postlarvae had to endure a lengthy automobile ride from an airport to the culture facilities. A closer and more economical source of prawn seed stock was needed to maximize research and development efforts. This paper reviews hatchery systems and techniques developed for production of postlarval prawns in Louisiana.

## PILOT SCALE HATCHERY

A pilot-scale prawn hatchery was constructed in 1982 at LAES's Ben Hur Farm, Baton Rouge, LA. This simple recirculating system consisted of three 1,600-L cylindrical fiberglass rearing tanks, one 1,400-L biofilter trough, and an elevated 1,600-L fiberglass brackish water mixing tank (Fig. 1). Brackish water (12‰) was prepared in the mixing tank and flowed by gravity into the rearing system. Water was recirculated continuously through the biofilter by a 1/8-hp magnetic-drive pump at a rate of 70 L/minute (approximately one complete rearing system turnover per hour). The filter trough contained a 30-cm layer of biodek<sup>1</sup> covered with a 15-cm layer of clam shell (*Rangia* sp.). A rotating biodisc filter mounted atop the filter trough turned continuously at a rate of 6 rpm (Fig. 2). A 1.5-kw cable heater (range 1-100°C) located in the bottom of the filter tank maintained water temperature at 28-30°C. Each rearing tank was also equipped with two 200-watt submersible heaters.

A 212- $\mu$ m screened PVC pipe (20-cm diameter  $\times$  90-cm length) was placed around the drain pipe in each rearing tank to retain larvae (Fig. 3). Air pumped through polyethylene air rings attached to the base of each pipe reduced screen clogging. Each rearing tank also contained four to six 7.5  $\times$  3.75  $\times$  3.75 cm glass-bonded air diffusers which aerated the water continuously. A 1.5-hp Conde carbon-vane air compressor supplied continuous aeration. A stainless

<sup>1</sup>Laminated sheets of corrugated black polyethylene utilized commercially for treatment of municipal and industrial wastewater.

Table 1.—Summary of prawn research in freshwater ponds at Ben Hur Research Area (LAES) and in brackish water ponds at Rockefeller Wildlife Refuge, 1979-84.

Year	Study location	Stocked ponds (n)	Stocked ponds (ha)	Prawn stocking density (per ha)	Prawn stocking size (g)	Growout period (d)	Supplemental feed	Average harvest weight (g)	Survival (%)	Yield (kg/ha)
1979	LAES	6	0.04 <sup>a</sup>	25,000	0.01	140	Yes	32	57	442
	Rockefeller	3	0.04	12,500	0.01	163	No	15	82	159
		3	0.04	25,000	0.01	163	No	11	77	191
		3	0.04	37,500	0.01	163	No	12	61	218
1980	LAES	6	0.04 <sup>a</sup>	25,000	0.01	144	Yes	37	16	122
	Rockefeller	3	0.04 <sup>a</sup>	50,000	0.01	144	Yes	24	22	266
		2	0.04	25,000	0.01	140	Yes	21	80	408
		3	0.04	49,000	0.01	140	Yes	17	72	619
		2	0.04	74,000	0.01	140	Yes	12	56	510
1981	Rockefeller	4	0.04	12,500	0.01	146	Yes	34	67	266
		3	0.04	25,000	0.01	146	Yes	23	64	353
		4	0.04	50,000	0.01	146	Yes	21	59	607
		4	0.04	75,000	0.01	146	Yes	19	51	644
1982	LAES	18	0.04 <sup>b</sup>	2,500	0.5-1	107	Yes	71	96	170
	Rockefeller	6	0.04	44,000	0.01	122	Yes	20	74	578
		6	0.04	44,000	0.01	122	Yes	24	73	704
1983	LAES	1	0.6 <sup>a</sup>	6,875	0.25	122	No	41	92	256
	LAES	9	0.04 <sup>a</sup>	5,000	0.01	106	Yes	31	89	—
		9	0.04 <sup>a</sup>	5,000	0.2	106	Yes	39	82	—
		5	0.12 <sup>c</sup>	5,000	0.01	92	Yes	25	86	119
	Rockefeller	5	0.04	44,000	0.01	141	Yes	17	76	588
		5	0.04	44,000	0.01	141	Yes	20	84	733
1984	LAES	4	0.04	4,942	0.08	106	Yes	54	60	115
	LAES	4	0.04	9,884	0.08	106	Yes	46	75	234
	LAES	4	0.04	14,826	0.08	106	Yes	34	46	256

<sup>a</sup>stocked with catfish

<sup>b</sup>stocked with catfish and chinese carps

<sup>c</sup>stocked with blue tilapia

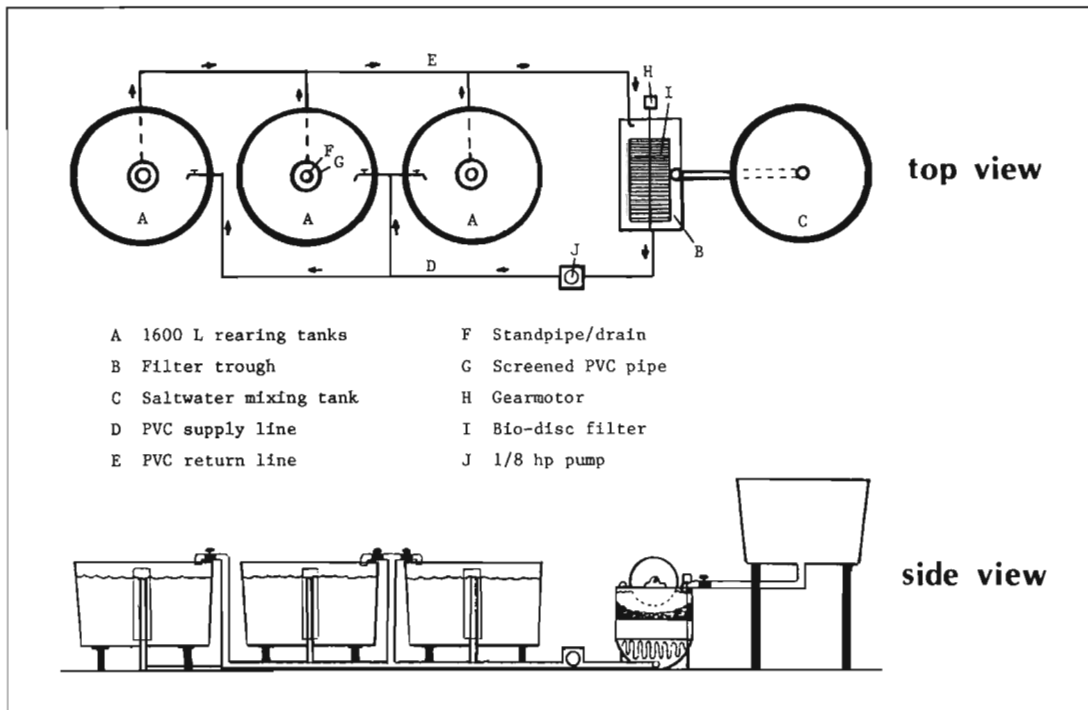

Figure 1—Initial recirculating system constructed at Ben Hur Farm for rearing larval Malaysian prawns (*Macrobrachium rosenbergii*) in South Louisiana, 1982.

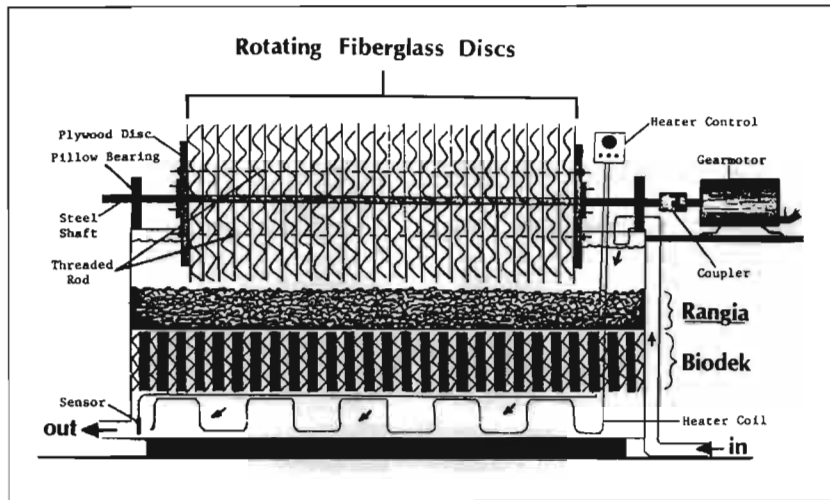

Figure 2—Detail of filter trough used in larval prawn rearing system.

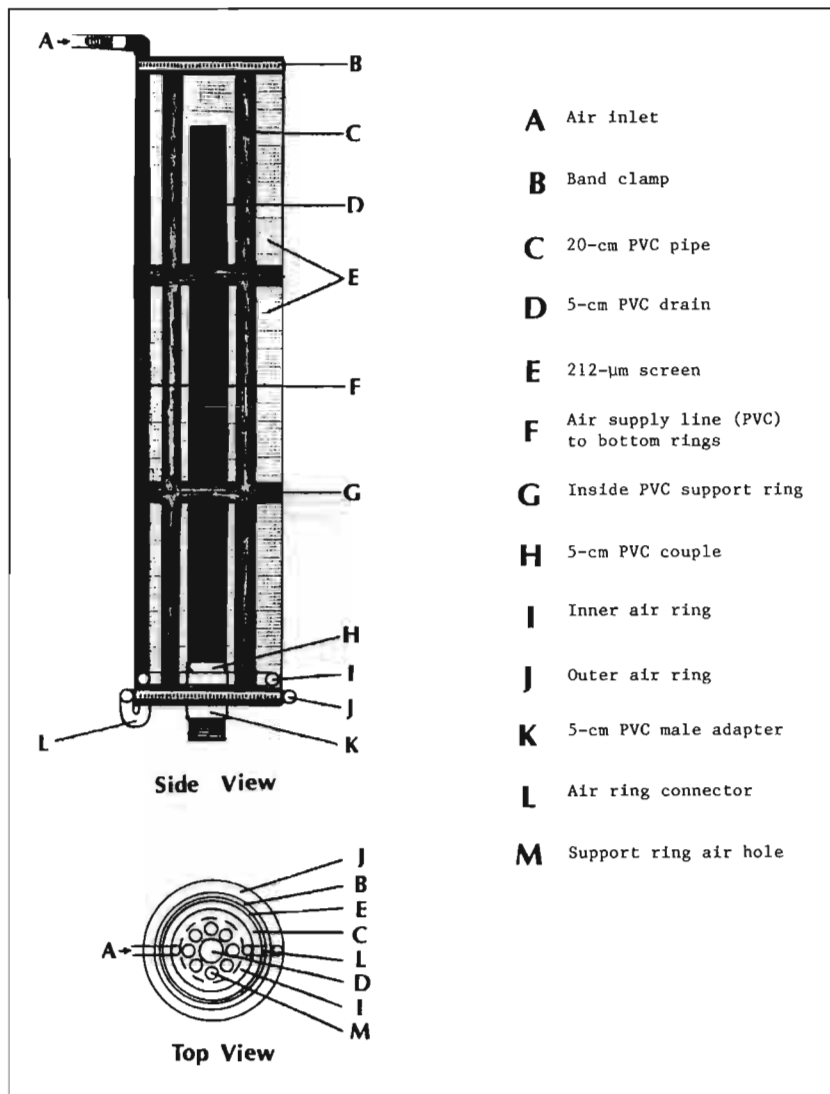

Figure 3—Detail of screened standpipe used to retain larval prawns in culture tanks.

steel "in-line" filter vessel containing a 5- $\mu$ m polypropylene filter bag removed carbon dust from the air lines.

Brine shrimp (*Artemia salina*) were hatched in six 58-L cone-bottom polyethylene tanks (Fig. 4). Three 75-watt lamps suspended above the hatching tanks supplied constant lighting. Each tank was aerated with an air diffuser and heated to 26-30°C by a 200-watt submersible heater.

Brine shrimp hatching water was prepared by adding 10 g/L NaCl or synthetic sea salts to Baton Rouge city water. Cysts were not decapsulated prior to hatching. Approximately 150 mL of cysts were added to 45-L of prepared water in each tank. Brine shrimp were subsequently harvested 24 and 30 hours later. The harvest procedure entailed removal of the airstone and disconnection of the heater in each tank. After 15 to 20 minutes, the contents of each tank separated into distinct layers. Hatched cysts floated, while unhatched cysts sank to the bottom. Newly hatched brine shrimp formed a dense layer immediately above the unhatched cysts and were harvested through the drain pipe.

Artificial lighting in the hatchery room was supplied by fluorescent lights and followed an approximate 12:12 photoperiod. Three windows on the north wall also supplied natural lighting.

## LARVAL PRODUCTION

The recirculating saltwater system was conditioned by stocking each culture tank with a few tilapia or brood prawns. After about 30 days, the recirculation water pump was turned off and all animals were removed. Water was drained completely from all culture tanks. Each culture tank was thoroughly cleaned and refilled with newly mixed brackish water (12‰). The water pump was then turned on and the system allowed to recirculate 1-2 days. Water temperature was stabilized at 28°C.

Larval production cycles were initiated by stocking 3-6 gravid female prawns (30-50 g each) with gray-colored eggs into each 1,600-L rearing tank. Hatching occurred 24-72 hours later, and all adult prawns were removed from tanks 72 hours after stocking. Hatching resulted in an initial density of approximately 30-60 prawn larvae/L.

Brine shrimp were fed to larval prawns ( $\geq$  stage II) twice per day in proportion to the volume of water in each tank. Brine shrimp densities were gradually reduced from 10-15/mL initially, to 1-2/mL immediately prior to prawn metamorphosis. The amount of brine shrimp utilized to maintain these concentrations was not quantified, but depended upon both prawn consumption and brine shrimp mortality in prawn culture tanks.

Initially (larval stages II-III), heavy feeding of brine shrimp (12-15/mL) caused a rapid formation of an "orange deposit" on tank bottoms. Consequently, siphoning of tanks was extremely important during this period to maintain water quality. As the rearing cycle progressed, brine shrimp stocking density decreased, while prawn feeding activity increased. Typically, brine shrimp stocked at 5/mL in the evening were reduced to 1-2/mL by morning, with little evidence of an orange deposit on the tank bottoms.

Steamed chicken egg was fed to prawn larvae beginning at approximately stage IV. Egg mix was prepared daily by mixing powdered eggs, water, and powdered protein hydrolysate, then steaming it until a firm consistency was obtained. The steamed mix was washed through a sieve series to obtain the proper particle size for larval consumption (Table 2). Egg particles were then collected in a beaker, covered with water, and refrigerated until needed (maximum 3 days). The feeding frequency and amount of egg mix fed to larvae were determined visually. Feeding frequency depended upon larval consumption, and ranged from once/day initially (stage IV) to four times/day prior to metamorphosis (stage XI). The amount fed was proportional to the number of prawn larvae present in each

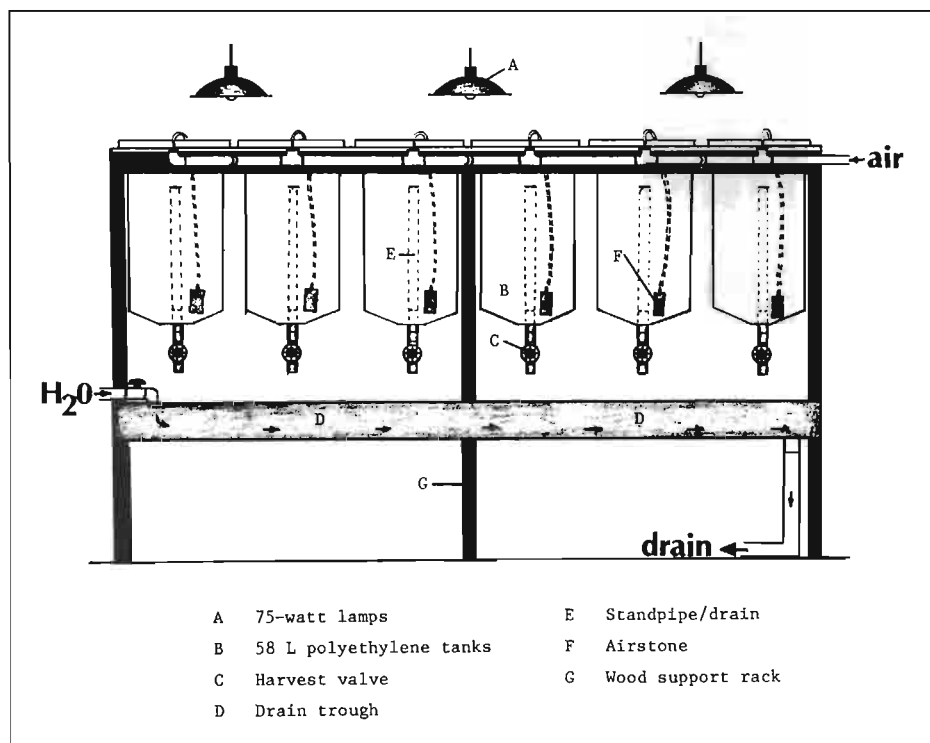

Figure 4—Tank system constructed to hatch brine shrimp (*Artemia salina*).

**Table 2—Sieve series (USA standard) used to produce food particle sizes for larval Malaysian prawns (*Macrobrachium rosenbergii*).**

Sieve position	Larval Stage			
	III-IV	V-VI	VII-IX	X-PL
Top	#40	#30	#20	#16
Intermediate	#20	#20	#16	#14
Intermediate	#30	—	—	—
Bottom	#60	#40	#30	#20

tank, and not to the water volume of each tank (as with brine shrimp). Aeration was turned off prior to each feeding. Initially (stages IV to V), small amounts of steamed egg were spread by hand over the water surface in each tank to provide approximately 1 egg particle/1-2 larvae. Larvae were relatively slow to accept egg particles during this phase. As development advanced (stages V to XI), egg was added until about 70-90% of the prawn larvae were observed holding particles within 1-2 minutes. This usually resulted in a ratio of 1-2 egg particles/larvae. Extreme caution was taken not to overfeed. Excess feed not only polluted the water, but also clogged standpipe screens and caused tank overflows. Standpipe screens were cleaned two to three times daily with a long-handled, soft-bristle brush, and bottoms were cleaned once daily with a siphon hose.

Approximately 100,000 postlarval prawns were produced during 1983-84 utilizing these materials and methods. Final tank production rates ranged from 5 to 15 postlarvae/L. Complete mortality was not experienced in any larval culture tank, and relatively low production rates were attributed to low initial stocking densities.

## NEW HATCHERY SYSTEM

Construction of a new 135-m<sup>2</sup> hatchery research building was completed at the Ben Hur Research Area in the Fall of 1984. This facility contains eight separate recirculating systems consisting of over 96 culture tanks ranging in size from 55 to 450 L. Each research system utilizes recirculating water pumped through a biofilter and ultraviolet sterilizer. The largest recirculating system is used for larval prawn rearing and consists of twelve 400-L conical fiberglass culture tanks (Fig. 5). This system was designed to maximize larval culture efficiency, while providing increased experimental control and flexibility.

Brackish water is prepared in an elevated 1,600-L fiberglass tank by combining Baton Rouge city water with synthetic seasalts and trace elements. The mixture is aerated vigorously for at least 24 hours, heated to 28°C, and then flows by gravity into the culture system. Each 400-L culture tank has the capability of utilizing "flow-through" city or pond water independent of other tanks utilizing recirculating water.

Culture water is filtered by continuous recirculation through biological, mechanical, and ultraviolet filters (Fig. 6). Two 2,000-L square polypropylene tanks serve as biofilters. Surface area for denitrifying bacteria is provided in the bottom of each filter tank by a 30-cm layer of biodek below a 30-cm layer of clam shell (*Rangia* sp.). In addition, each filter tank is equipped with a 1.5-kw immersion tube heater to maintain water temperature at 28°C. After leaving the biofilters, rearing water is pumped through a particle filter unit to remove suspended, colloidal, and dissolved solids. This unit contains 9.3 m<sup>2</sup> of 5- $\mu$ m polypropylene filter mesh around a 3.6-kg canister of activated carbon. The final step in the water filtra-

tion process is provided by two ultraviolet sterilizers, each containing two 60-watt UV lights. Bacteria and other pathogenic organisms are killed as the culture water flows through each unit. Filtered water is pumped back to the culture tanks by a 1/2-HP magnetic drive pump at a maximum rate of 175 LPM. Water flow into each culture tank is regulated by a 12-cm PVC ball valve and quantified by a variable area flowmeter (range 1.8-18 LPM).

Each rearing tank is initially equipped with a 20-cm PVC pipe frame covered with 210- $\mu$ m nitex screening to retain stage I-V prawn larvae. However, as larval size increases (stages VI-XI) and brine shrimp densities decrease (12/mL to 1/mL), a smaller 10-cm PVC pipe frame covered with a larger 280- $\mu$ m screening is used. One 7.5  $\times$  3.75  $\times$  3.75 cm glass-bonded air diffuser is placed under each standpipe at the bottom of the tank cone to prevent settling of animals and debris. Air flow into each culture tank is regulated by a 12-cm PVC ball valve and quantified by a variable area flowmeter (range 0-15 SCFM).

## LARVAL PRODUCTION

Stocking of larval culture tanks was initiated in January 1985. Two to twelve gravid female prawns were placed directly into each culture tank. All females were removed from the tanks 48-72 hours later. Larvae were left in the tanks where they had hatched. Initial larval densities were estimated in each tank by taking three to four 100-mL samples with a plastic tube while aerating the water vigorously. The number of larvae counted in each sample was extrapolated to a liter basis and then multiplied by the tank volume to estimate total tank population. Larval densities in each tank were estimated daily using the plastic tube sampler until about day 15, and then by using a 500-mL beaker until tank harvest. At least five larvae from each tank were staged daily by microscopic examination. This provided a daily index for larval condition, growth, and development.

Brine shrimp were fed daily to prawn larvae until about day 25. Brine shrimp densities in culture tanks were relatively low throughout the cycle due to limited hatching tank volume, and ranged from 2 to 10/mL. A mixture of chicken eggs, squid, and protein supplements was steamed, sieved, and fed daily to larvae beginning at stage III. The frequency and amount of egg mix fed to larvae were determined visually, but generally increased with larval development. Feeding procedures closely followed those outlined earlier for the previous hatchery system.

All tanks were harvested after 36-55 days by removing the standpipe in each tank and flushing all postlarvae into a screened bucket. Harvest was delayed in several tanks to facilitate conditioning of juvenile nursery tanks. Tank populations at harvest were estimated on a weight basis.

The production results from the first larval cycle are presented in Table 3. After an average of 46 days, production averaged 11 postlarvae/L. Postlarvae averaged 0.01 g each. The number of days necessary for  $\geq 50\%$  of the population in each tank to reach a particular larval stage are presented in Table 4. An average of 3 days occurred between larval stages. Earlier stages were generally passed through more quickly than later stages. The daily population density estimates from each tank are presented in Figure 7. Larval mortality rates were high through approximately day 15-17, but decreased considerably thereafter.

We believe the low production average was due to the high initial mortalities experienced in all tanks. These high mortalities may have been caused by low brine shrimp densities during the early

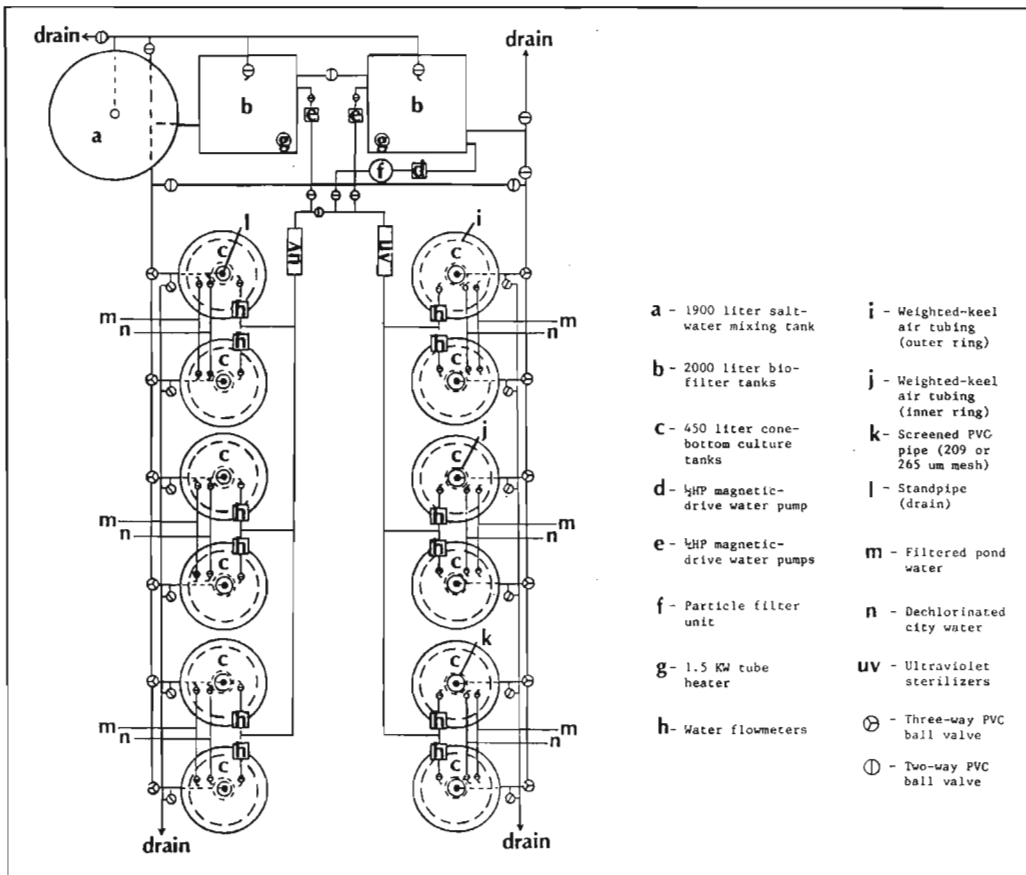

Figure 5—Newly constructed recirculating system for rearing larval Malaysian prawns (*Macrobrachium rosenbergii*) at Ben Hur Farm, Baton Rouge, Louisiana.

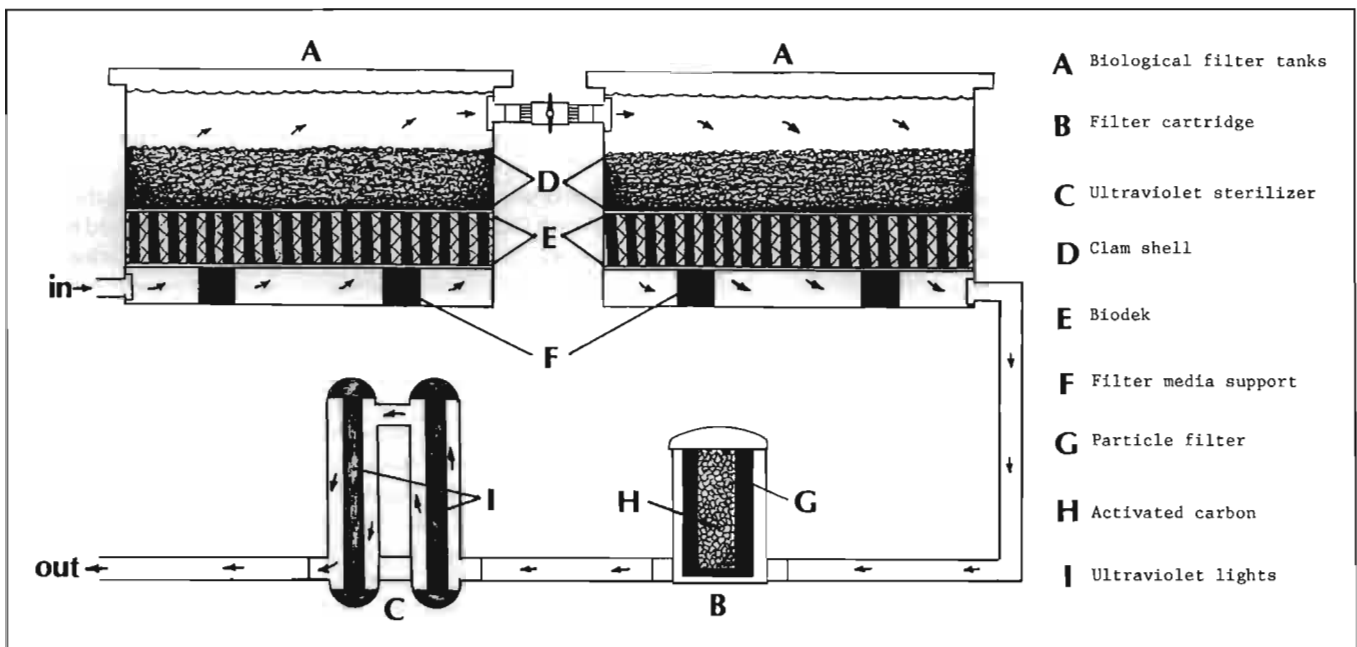

Figure 6—Detail of water filtration components of larval prawn rearing system.

**Table 3—Production data from the initial larval prawn rearing cycle at the new LAES hatchery in January 1985.**

Tank no.	Initial larval density <sup>1</sup> (no./L)	Days to first P.L. (no.)	Days to harvest (no.)	P.L. density at harvest (no./L)	Avg. P.L. wet weight (g)
1	— <sup>2</sup>	25	50	8.4	0.019
2	37	25	47	5.7	0.010
3	290	22	40	27.6	0.007
4	127	27	49	13.1	0.011
5	50	19	36	12.5	0.007
6	98	25	44	16.7	0.010
7	66	27	55	6.0	0.022
8	333	24	45	13.5	0.011
9	— <sup>2</sup>	28	50	11.2	0.012
10	110	24	48	8.0	0.010
11	140	25	44	0.8	—
12	155	23	44	8.7	0.009
Average ( $\bar{x} \pm 1SD$ )	141 ± 98	24 ± 2	46 ± 5	11.0 ± 6.7	0.010 ± 0.005

<sup>1</sup>Due to eggs hatching over a several day period, values represent highest density recorded from each tank.

<sup>2</sup>Values deleted because larvae from other tanks were added during the cycle.

**Table 4—Number of days necessary for ≥50% of prawn larvae to achieve stages of development at the new LAES hatchery in January, 1985.**

Stage	Day ( $\bar{x} \pm 1SD$ )
I	—
II	3.1 ± 0.8
III	5.6 ± 1.3
IV	8.3 ± 1.9
V	10.4 ± 1.9
VI	13.1 ± 1.8
VII	16.1 ± 2.3
VIII	21.1 ± 2.8
IX	23.7 ± 3.5
X	25.2 ± 5.0
XI	28.8 ± 4.0
PL	33.7 ± 3.2

stages of growth. In clear water systems, brine shrimp are usually stocked initially at 10-15 brine shrimp/mL. However, we were only able to supply approximately 2-10 brine shrimp/mL during the early stages. Moreover, the delayed harvest of several tanks resulted in excessive mortality of postlarvae. Water quality parameters were within acceptable limits for larval prawn culture. Salinity ranged from 12 to 13‰; temperature averaged  $28.7 \pm 1.3^\circ\text{C}$ ; pH averaged 7.8; and ammonia concentration ranged from 0.001 to 0.002 mg/L.

Future research efforts will be directed toward reducing hatchery costs for production of postlarval prawns. Experiments will be undertaken to investigate the effect of brine shrimp density on larval growth and survival, and to assess several formulated diets which could minimize brine shrimp usage.

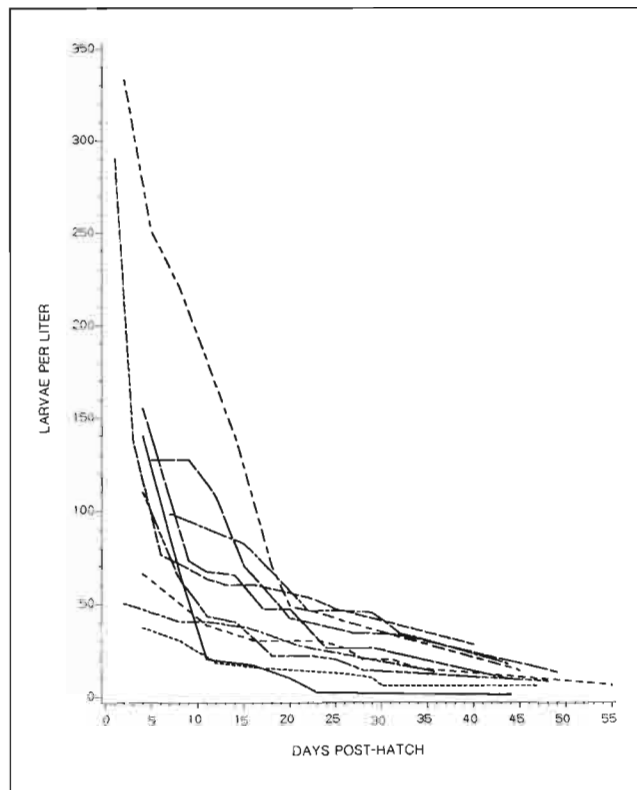

**Figure 7—Daily estimates of larval prawn densities in ten culture tanks at Ben Hur Farm in January 1985.**

## CITATIONS

- CANGE, S. W., J. W. AVAULT, and W. G. PERRY.  
1983. *Macrobrachium rosenbergii* culture in southwest Louisiana in brackish water ponds. In Proc., 1st Int. Conf. Warmwater Aquacult., p. 148-156. Brigham Young Univ.
- CANGE, S. W., D. PAVEL, and J. W. AVAULT.  
In press. Pilot study on prawn/catfish polyculture with rice/crayfish rotation. In Proc., 7th Int. Crayfish Symp., Lund, Sweden.
- HUNER, J. V., W. G. PERRY, Jr., M. MILTNER, R. A. BEAN, and J. W. AVAULT, Jr.  
1980. A preliminary study into the polyculture of giant Malaysian prawns, *Macrobrachium rosenbergii*, and channel catfish, *Ictalurus punctatus*, in Louisiana. Proc. La. Acad. Sci. 54:95-103.
- MILTNER, M. R., A. GRANADOS, R. ROMAIRE, J. W. AVAULT, Jr., Z. RA'ANAN, and D. COHEN.  
1983. Polyculture of the prawn, *Macrobrachium rosenbergii* with fingerling and adult catfish, *Ictalurus punctatus*, and Chinese carps *Hypophthalmichthys molitrix*, and *Ctenopharyngodon idella*, in earthen ponds in South Louisiana. J. World Maricult. Soc. 14:127-134.
- PAVEL, D. L., J. W. AVAULT, Jr., and S. W. CANGE.  
1985. Polyculture of channel catfish, *Ictalurus punctatus* (Rafinesque), with post-larval and juvenile prawns, *Macrobrachium rosenbergii* (DeMan). In Proc., 16th Annu. Meet. World Maricult. Soc., Jan. 13-17, 1985, Orlando, Fla.
- PERRY, W. G., and J. TARVER.  
1981. Malaysian prawn culture in brackish ponds in Louisiana. J. World Maricult. Soc. 12(2):214-222.  
In press. Production trials of prawn comparing a marine ration, catfish diet and agricultural range pellet. In Proc., 38th Annu. Meet. S.E. Assoc. Fish Wildl. Agencies, New Orleans, La.





# Changing Sexual-State Relationships of a Population of Red Swamp Crawfish *Procambarus clarkii*

ROBERT J. RHODES

JAMES W. AVAULT, JR.

*School of Forestry, Wildlife, and Fisheries*

*Louisiana Agricultural Experiment Station*

*Louisiana State University Agricultural Center*

*Baton Rouge, Louisiana 70803*

## ABSTRACT

Greater variation of individual sexual states of male crawfish (form-1 and form-2) and female crawfish (virgin and inseminated) was found in samples taken toward the end of the harvesting season. Mature males and females dominated at the beginning and end of the harvest season. High-nitrogen fertilized ponds showed different sexual-state ratios than low-nitrogen ponds. There was a significant ( $P < 0.05$ ) difference between percentage ratios of adult females to subadult females.

## INTRODUCTION

There is some general understanding of *Procambarus clarkii* population dynamics. Crawfish burrow underground in the summer, produce eggs with the fall or winter floods, and mature in the spring. The relationship of sexual states has been treated only superficially with respect to crawfish population dynamics (Sheppard 1974; Huner 1975; Huner and Avault 1976; Huner 1978).

Some crawfish population estimates of recruits and sex ratios have been calculated within a trapping season. Huner (1975) noted a male:female ratio of 1:1.09. Huner and Avault (1976) found the male:female ratio as 1:1. Huner (1978) also described male:female ratios within and between seasons as 1:1 for all study ponds. Sheppard (1974) in Alligator Bayou, Louisiana, consistently caught more females than males from 1972 to 1974. Our objective in the present study was to assess changing sexual-state ratios of crawfish over time, and the effect of nitrogen fertilization on these ratios.

## MATERIALS AND METHODS

The field site was Louisiana State University's Ben Hur Farm, 4.8 km south of the main campus at Baton Rouge, Louisiana. Sixteen ponds, approximately 0.05 ha  $\times$  1 m deep, were planted with rice forage and fertilized with 26 or 222 kg/ha of nitrogen (Rhodes 1982).

Sex ratios were determined for crawfish caught by trapping and hand picking in drained ponds. Trapping continued from 2 November 1980 to 3 May 1981, with a total trapping effort of 2,840 trap-sets/ha.<sup>1</sup> About 50% of the total crawfish catch was hand picked at the time of pond draining (1-3 May 1981).

All captured animals were examined ventrally for sexual state (males, form-1 or form 2; and females, virgin or inseminated). Known inseminated and virgin states were determined by drawing a No. 2 lead pencil across the annulus ventralis. If it was vertically out of round and/or striated, allowing the pencil to leave graphite on it, the female was considered inseminated and/or sexually active. Otherwise, she was considered a virgin. Form-1 males had distinct hooks on the 3rd pair of walking legs; form-2 males had less distinct hooks. Females were used as a general indicator for separating parental stock from recruits, because once inseminated their annulus ventralis remains striated. Males, however, can change from form-1 to form-2 and back again.

## RESULTS AND DISCUSSION

Sexual states changed through time and with capture method. Individual ponds differed in the pulse of male and female populations and their sexual states. The ratio of all males (forms 1 and 2) to all females (inseminated and virgin) decreased from fall to draining in the spring (Table 1). For male crawfish, the ratios of form-1 to form-2 were nonsignificant ( $P > 0.05$ ) in low-nitrogen and high-nitrogen ponds. The ratio of inseminated to virgin females showed a very close and significant ( $P < 0.05$ ) parallel (in high- and low-nitrogen ponds) from the beginning of trapping to draining, separated by a 10-20% gap from December to April. The ratios of form-2 males to virgins in both treated ponds was nonsignificant. The ratio of form-1 males to inseminated females decreased

<sup>1</sup>A "trap-set" is one trap, set and harvested in one day.

from November to January, increased until April, and decreased upon draining. The high- and low-nitrogen fertilization treatments were separated by a nonsignificant ( $P > 0.05$ ) gap until the spring, when the high treatment was greater than the low treatment.

Sexual-states were similar for both the high- and low-nitrogen fertilization treatments, giving the impression of stable, seasonal trends. Previous researchers (Sheppard 1974; Huner 1975; Huner and Avault 1976; Brown and Bowler 1977; Huner 1978) have stated that sex ratios are very close to 1:1 (male:female) during and between harvests. Not only does a 1:1 male:female ratio indicate an unrealistic state, but a deviation around the 1:1 indicates a dynamic balanced change to encourage compensatory growth in females when males are being harvested with traps (Brown and Bowler 1977; Goldman and Rundquist 1977) or to inhibit female reproduction when crawfish and/or male densities are high (Brown and Bowler 1977; Niemi 1977). In our study, the ratio of males to females was greater than 1:1 throughout the season. Under harvest, the crawfish population showed a decreasing ratio approaching 1:1 through time. The natural ecosystem has shown a ratio less than 1:1 throughout the year (Sheppard 1974).

Differential loss of a sex or age group in terms of a changing ratio is a predictive tool for examining a population (Selleck and Hart 1957; Paulik and Robson 1969). The high-nitrogen ponds produced 20-40% fewer form-1 crawfish than inseminated crawfish until December. Indirect confirmation of the decrease in form-1 males is found in the appearance of virgin females in the fall, the rapid increase of form-2 (growth phase) males to the exclusion of form-1 males until January, and the rapid increase in virgins as compared with inseminated females and form-2 males. With a decrease in population at the beginning of the flooded season, density-related growth would increase, explaining the increases in relative appearances of individual sexual-state forms (Paulik and Robson 1969). The higher ratios of sexually mature combinations in the high-nitrogen ponds at the end of the flooded season, while lower for the sexually immature, are compensatory in adjusting the high-nitrogen population to the low-nitrogen population. Finally, although virgins in the high-nitrogen populations lack the sharp recruitment peak in the low-nitrogen populations, virgin recruitment takes place over a longer period. Again, this suggests increased compensatory growth due to a decrease in parental stock.

Table 1—Monthly ratios of crawfish group means from experimental crawfish ponds at Ben Hur Farm, La. State Univ., Baton Rouge, La.

Crawfish group ratio	Nitrogen level	Month						Pond draining
		N	D	J	F	M	A	
Males:Females								
	low	2.73	2.00	10.00	1.12	1.25	1.23	1.05
	combined	2.67	1.65	1.67	1.09	1.32	1.29	1.08
	high	1.67	0.50	1.67	0.90	1.57	1.59	1.16
Paired <i>t</i> test <sup>1</sup>								
<i>t</i> = 1.260, $P > 0.05$ .								
Adults:Sub-adults								
	low	2195.67	2.54	0.88	0.72	0.66	9.05	2.89
	combined	38.60	2.46	0.74	0.66	0.68	7.25	3.25
	high	3.00	1.00	0.33	0.27	0.73	4.00	4.37
Paired <i>t</i> test								
<i>t</i> = 1.003, $P > 0.05$ .								
Inseminated:Virgins								
	low	—	—	5.00	1.05	1.14	11.42	33.68
	combined	—	16.00	4.00	0.96	1.07	7.77	20.10
	high	—	3.00	2.00	0.43	0.84	2.92	10.06
Paired <i>t</i> test								
<i>t</i> = 1.650, $P < 0.05$ .								
Form-1:Form-2								
	low	45.33	1.36	0.33	0.50	0.41	7.70	1.11
	combined	27.80	1.33	0.25	0.45	0.46	6.89	1.45
	high	1.50	1.00	0.00	0.13	0.67	5.05	2.72
Paired <i>t</i> test								
<i>t</i> = 1.049, $P > 0.05$ .								
Form-1:Inseminated								
	low	2.67	1.15	0.50	0.73	0.69	1.18	0.57
	combined	2.57	1.00	0.42	0.70	0.81	1.28	0.67
	high	1.00	0.33	0.00	0.33	1.38	1.78	0.93
Paired <i>t</i> test								
<i>t</i> = 0.766, $P > 0.05$ .								
Form-2:Virgin								
	low	—	—	7.50	1.53	1.90	1.75	17.32
	combined	—	12.00	6.67	1.47	1.86	1.44	9.34
	high	—	1.00	5.00	1.14	1.74	1.03	3.44
Paired <i>t</i> test								
<i>t</i> = 1.347, $P > 0.05$ .								

<sup>1</sup>Difference between low and high nitrogen levels.

## CITATIONS

- BROWN, D. J., and K. BOWLER.  
1977. A population study of the British freshwater crawfish *Austropotamobius pallipes* (Lereboullet). In Lindqvist, O. V. (ed.), 3rd Int. Symp. of Freshwater Crawfish, Kuopio, Finland, p. 33-49.
- GOLDMAN, C. R., and J. C. RUNDQUIST.  
1977. A comparative ecological study of the California crawfish, *Pacifastacus leniusculus* (Dana), from two subalpine lakes (Lake Tahoe and Lake Donner). In Lindqvist, O. V. (ed.), 3rd Int. Symp. of Freshwater Crawfish, Kuopio, Finland, p. 51-80.
- HUNER, J. V.  
1975. Observations on the life histories of recreationally important crawfishes in temporary habitats. Proc. La. Acad. Sci. 38:20-24.  
1978. Crawfish population dynamics as they affect production in several small, open commercial crawfish ponds in Louisiana. In Avault, J. W., Jr. (ed.), Proc., 9th Annu. Meet., World Maricult. Soc., p. 619-640.
- HUNER, J. V., and J. W. AVAULT, Jr.  
1976. Sequential pond flooding: A prospective management technique for extended production of bait-sized crawfish. Trans. Am. Fish. Soc. 105:637-642.
- NIEMI, A.  
1977. Population studies on the crawfish *Astacus astacus* L. in the River Pyhäjoki, Finland. In Lindqvist, O. V. (ed.), 3rd Int. Symp. Freshwater Crawfish, Kuopio, Finland, p. 81-94.
- PAULIK, G. J., and D. S. ROBSON.  
1969. Statistical calculation for change-in-ratio estimates of population parameters. J. Wildl. Manage. 33:1-27.
- RHODES, R. J.  
1982. Crawfish (*Procambarus clarkii*) production under two rice (*Oryza sativa*) varieties, two levels of nitrogen fertilization and two crawfish stocking rates. M.S. Thesis, La. State Univ., Baton Rouge, 86 p.
- SELLECK, D. M., and C. M. HART.  
1957. Calculating the percentage of kill from sex and age ratios. Calif. Fish Game 43:309-316.
- SHEPPARD, M. F.  
1974. Growth patterns, sex ratio and relative abundance of crayfishes in Alligator Bayou, Louisiana. M.S. Thesis, La. State Univ., Baton Rouge, 54 p.

# A Note on Recruitment Cycles for the Red Swamp Crawfish *Procambarus clarkii*

ROBERT J. RHODES  
 JAMES W. AVAULT, JR.  
*School of Forestry, Wildlife, and Fisheries*  
*Louisiana Agricultural Experiment Station*  
*Louisiana State University Agricultural Center*  
*Baton Rouge, Louisiana 70803*

The red swamp crawfish, *Procambarus clarkii*, burrows into the ground in the summer, bears young with fall or winter floods, and the young mature in the spring. However, multiple recruitment can occur without a definite explanation (Penn 1943; Huner 1975, Romaine 1976; Witzig 1980). Knowledge of crawfish recruitment cycles is limited to field observations. Crawfish ponds are typically flooded after September which results in young-of-the-year recruitment (Huner and Avault 1976). A small, post-flooding recruitment peak occurs in December and another smaller peak in March (Romaine 1976; Huner and Avault 1976; Huner 1978).

In this study, recruitment was examined over 8 months in laboratory aquaria. Eight 22-L and eight 2-L aquaria with under-gravel filters were used. Four females and two males were randomly assigned to each 22-L aquaria, and one, two, or three females and one male to each 2-L aquaria on 23 July 1980.

Crawfish were fed carrots and brown rice until December and a crustacean ration thereafter. They were checked daily for deaths and for appearance of ovipositioned eggs. In mid-December, all surviving females in oviposition were restocked into 22-L aquaria to observe their life span and whether they could produce a second clutch of eggs. One male was added to those aquaria lacking a surviving males. Again, deaths and appearance of ovipositioned eggs were recorded, and the study terminated 1 October 1981.

In this study there was specific seasonal timing of egg release similar to observed fall and spring recruitment in the field. Percentage of total ovipositioned females were:

1980				1981			
Sept.	Oct.	Nov.	Dec.	Jan.	Feb.	March	April
24	56	9	4	0	0	0	17

Of 95 females, 57 escaped, 38 were retained, and 34 ovipositioned.

Romaine (1976) and Witzig (1980) reported that from fall through summer in experimental crawfish ponds, there were one major and two minor peaks of recruitment. Recruitment was largest in October with smaller peaks in late December and early March. Similar seasonal peaks of recruitment (up to five) have been reported by other researchers in natural areas and commercial crawfish ponds (Penn 1943; Suko 1956; de la Bretonne and Avault 1976; Huner 1978; Huner and Avault 1976; Witzig 1980).

After females in aquaria went into oviposition, mortalities and deformities greatly increased following molting. Females before ovipositioning, and males throughout the study, molted with little or no deformities. Major mortalities have occurred in the field with molting of *Orconectes virilus* (Momot 1967). It appears that *P. clarkii* can deliver one clutch successfully, but a second clutch is difficult.

Parents grew before the second oviposition. Penn (1943) and Suko (1958) noted growth and development of *P. clarkii* after egg release. Suko (1958) had two females carry a second clutch 3 months after the first. However, they did not grow between clutches and utilized underdeveloped oocysts from the first clutch for an oviposition of a minor amount, from 518 to 37 and from 420 to 171 ovipositioned eggs for the two females. Following is our data for females having a second clutch of eggs in the laboratory:

Individual	First clutch			Second clutch			
	Date	Female length (mm)	Eggs (no.)	Molt (s)	Date	Female length (mm)	Eggs (no.)
A	10/09/80	90	161	1	4/02/81	93	427
B	10/12/80	88	309	1 <sup>1</sup>	4/15/81	100	517
C <sup>2</sup>	10/14/80	97	—	1	4/15/81	98	347

<sup>1</sup>Probably more than one occurred, although only one was observed.  
<sup>2</sup>The first clutch occurred in 4 ml of water in a bucket. Eggs and glair covered her body, instead of the pfcopods. An egg count was not made.

The females that go into oviposition (first cohort) in the fall may also go into oviposition in late December if they develop the few residual oocysts (Suko 1958). Females going into second oviposition in late December normally do not go into oviposition in early March because of reduced water temperature and slower development (Mermilliod 1976), unless they molt and develop more oocysts during the remainder of the fall before cold winter temperatures reduce growth.

It is improbable that sexual development and oogenesis could occur before winter for fall-spawned hatches (Mermilliod 1976; Witzig 1980). A second cohort in December is thought to come from juvenile crawfish which previously burrowed underground when ponds were drained the previous spring/summer.

Recruitment rapidly diminishes in the spring (Huner 1978; Penn 1943; Romaire 1976; Witzig 1980). Inseminated females and males with sperm in sperm-ducts at the end of the harvesting season (May/June) produce the first recruitment of young when ponds are flooded in the fall (Green 1961; Clarke 1973). When fall flooding occurs, surviving juveniles grow, resume oogenesis, and spawn 4-5 months later in December (de la Bretonne and Avault 1976) as the second cohort. These survivors probably comprise the bulk of the early crop in the commercial crawfish ponds in Louisiana (de la Bretonne and Avault 1976). An example of this was described by Miltner (1980). Most of his total catch in older ponds was bimodal, with fall and spring peaks, whereas in new ponds it was a unimodal, spring catch.

In summary, recruits occur in three distinct peaks, fall, early winter, and early spring, by two separate crawfish populations. The fall and early spring recruits come from the same parental stock that survive harvesting to have two ovipositions per female. The early winter recruits are produced from the previous season's crawfish which were juveniles at pond draining in spring/summer.

## CITATIONS

- CLARKE, K. U.  
1973. The biology of the arthropoda. American Elsevier Publ. Co., Inc., New York, 270 p.
- de la BRETONNE, L., and J. W. AVAULT, Jr.  
1976. Egg development and management of *Procambarus clarkii* (Girard) in a south Louisiana commercial crawfish pond. *In Proc., Int. Symp. Freshwater Crawfish* 3:133-140.
- GREEN, J.  
1961. A Biology of Crustacea. Quadrangle Books, Chicago, 180 p.
- HUNER, J. V.  
1975. Observations on the life histories of recreationally important crawfishes in temporary habitats. *Proc. La. Acad. Sci.* 38:20-24.  
1978. Crawfish population dynamics as they affect production in several small, open commercial crawfish ponds in Louisiana. *Proc., Annu. Meet., World Maricult. Soc.* 9:619-640.
- HUNER, J. V., and J. W. AVAULT, Jr.  
1976. Sequential pond flooding: a prospective management technique for extended production of bait-sized crawfish. *Trans. Am. Fish. Soc.* 105:637-642.
- MERMILLIOD, W. J.  
1976. Life history and ecology of the large river shrimp *Macrobrachium ohione* Smith. M.S. thesis, La. State Univ., Baton Rouge, 87 p.
- MILTNER, M. R.  
1980. Evaluation of domestic rice, *Oryza sativa*, and Japanese millet, *Echinochloa frumentacea*, as fodder for red swamp crawfish, *Procambarus clarkii*. M.S. thesis, La. State Univ., 106 p.
- MOMOT, W. T.  
1967. Population dynamics and productivity of the crawfish, *Orconectes virilis*, in a marl lake. *Am. Midl. Nat.* 78:55-81.
- PENN, G. H., Jr.  
1943. A study of the life history of the Louisiana red-crawfish, *Cambarus clarkii*, Girard. *Ecology* 24:1-18.
- ROMAIRE, R. P.  
1976. Population dynamics of red swamp crawfish, *Procambarus clarkii* (Girard), in ponds receiving fertilization, and two agricultural forages as supplemental feed. M.S. thesis, La. State Univ., Baton Rouge, 92 p.
- SUKO, T.  
1958. Studies on the development of the crawfish; VI. The reproductive cycle. *Sci. Rep. Saitama Univ., Serv. Bull.* 3:79-91.
- WITZIG, J. F.  
1980. Spatial and temporal patterns of macroinvertebrate communities in a small crawfish pond. M.S. thesis, La. State Univ., Baton Rouge, 113 p.

# Production of Triploid Channel Catfish Fry

WILLIAM R. WOLTERS

*School of Forestry, Wildlife, and Fisheries  
Louisiana Agricultural Experiment Station  
Louisiana State University Agricultural Center  
Baton Rouge, Louisiana 70803*

## INTRODUCTION

---

Channel catfish are widely cultured because they are easily managed and have good food quality. Although much research has been performed on rearing, stocking, and nutrition of channel catfish, less research has been directed toward genetic improvements that would increase its value as a cultured species.

One genetic improvement that may provide benefits to fish culture is the production of triploid individuals. Natural spontaneous triploidy in fish is rare (Cuellar and Uyeno 1972; Gold and Avise 1976; Allen and Stanley 1978; Thorgaard and Gall 1979), but has been successfully induced by cold-shocking fertilized eggs in plaice, *Pleuronectes platessa*; its hybrid with the flounder, *Platichthys flesus* (Purdom 1972); three spine stickleback, *Gasterosteus aculeatus* (Swarup 1959a); blue tilapia, *Tilapia aurea* (Valenti 1975); carp, *Cyprinus carpio* (Gervai et al. 1980); channel catfish, *Ictalurus punctatus* (Wolters et al. 1981b); and rainbow trout, *Salmo gairdneri* (Lincoln 1982). Triploid individuals might be expected to be larger than their diploid counterparts, in accordance with the general hypothesis that nuclear size increases in proportion to chromosome number while the nuclear-cytoplasmic volume ratio is maintained (Fankhauser 1945; Swarup 1959b). Swarup (1959b), however, found triploid threespine sticklebacks to be no larger than diploids; cellular size increased, but the number of cells per organ decreased. Purdom (1976), Valenti (1975), and Wolters et al. (1982a) found induced triploid plaice-flounder hybrids, blue tilapia, and channel catfish to be significantly larger than normal diploids. These triploids may have differed from triploid threespine sticklebacks in their indeterminate growth pattern. The regulatory mechanism proposed by Swarup (1959b) may have been absent, causing these triploid fish to be larger.

Channel catfish are often cultured for food consumption to sizes near and above 0.5 kg. They begin primary oocyte production as juveniles, and can be sexually mature as small as 0.33 kg (Bardach et al. 1972; Meyer et al. 1973; Grizzle and Rogers 1976). Polyploid fish have been found to have reduced gonadal development and grow faster than diploids during periods of gonad development (Purdom 1976; Allen and Stanley 1978; Thorgaard and Gall 1979; Gervai et al. 1980). Triploid channel catfish in commercial culture may also avoid depressed growth and poorer feed conversion characteristic of sexual maturation, and therefore be more profitable to raise than diploids. This paper describes methods to produce triploid channel catfish fry and fingerlings, and possible benefits to commercial producers.

## METHODS

---

### Spawning and triploid induction

Sexually mature channel catfish can be obtained by seining brood ponds during the spawning season. Males are selected on the basis of prominent tertiary sex characters such as large, dark colored, and muscular heads. Females near spawning are selected for full, well-rounded abdomens past the pelvic fins, and the female genital area becomes red, swollen, and often pulsates as spawning time approaches (Meyer et al. 1973; Smitherman et al. 1978).

In order to induce triploidy, complete control over the spawning process by the culturist is required. Such intensive methods are necessary in order to obtain and properly manipulate the eggs and sperm within a short period of time.

Male and female catfish can be paired for spawning in suitable sized aquaria, tanks, or concrete troughs utilizing dividers to form pens. Care should be taken to place males and females of similar size in the spawning tanks. Tanks can vary in size from 40 to several thousand liters. Spawning shelters are generally required only in large tanks allowing more fish movement. Water supply into the tanks should be with 24-28°C well-aerated water at a rate necessary to maintain adequate water quality. Female catfish can be induced to ovulate with daily injections (4.4 mg/kg) of carp pituitary extract or human chorionic gonadotropin (1100-1800 IU/kg). Two to three injections may be needed depending on the condition of the female.

When female fish are observed to be ovulating freely, the eggs can be handstripped and fertilized with sperm from mascerated testes of donor males (Dupree et al. 1969). Beginning 5 minutes after fertilization, eggs are cold-shocked at 5°C for 1 hour (Wolters et al. 1981b). After treatment, the eggs are transferred without acclimation to a standard hatching tray. Disease treatment of eggs may be needed to control fungus from small pieces of testes imbedded in the egg mass during fertilization. After hatching, fry can be reared to fingerling size by commonly used methods (Meyer et al. 1973; Jensen et al. 1983).

### Determination of ploidy levels

A determination of the degree of success in triploid induction should be made. Triploidy ( $3n = 87$ ) can be confirmed from chromosome counts of cultured lymphocytes, mascerated kidney tissue, or developing embryos (Kligerman and Bloom 1977; Hollenbeck and Chrisman 1981; Wolters et al. 1981a). These methods are accurate and direct, but relatively time-consuming, expensive, and require skilled personnel. Triploidy in catfish can also be estimated from measurement of erythrocyte nuclei (Wolters et al. 1982b). Approximately 92% accuracy can be obtained from this method; however, it is relatively easy, rapid, and requires little specialized equipment.

## RESULTS AND DISCUSSION

### Success of triploid induction

Females in good spawning condition should ovulate after 1 to 3 injections. With practice, 100% fertilization is possible, and the incidence of triploidy can be 100%. Cold shocks longer than 1 hour are not necessary and have caused 100% mortality in developing embryos (Wolters et al. 1981b).

Although it has not been proven, triploidy probably results from nonextrusion of the second polar body (Purdom 1969). Triploid catfish are as viable as their diploid full sibs and tolerate the polyploid condition well. Triploid catfish do not appear to be different morphologically from diploids; however, it has been noted that triploid catfish appear to have a darker coloration than diploids.

### Growth rates and gonad development

Experimental studies conducted in 870-L fiberglass tanks equipped with biofiltration have shown that from 2 until 16 months of age, diploid and triploid fish consumed equal amounts of food. However, triploid fish were significantly heavier than full-sibling diploids after the eighth month because of better feed conversion: 1.19 vs.

**Table 1—Mean weights, feed consumption, and feed efficiency of diploid and triploid channel catfish from 2 to 16 months of age (Wolters et al. 1982a). Asterisks (\*) denote significant difference in weight ( $P < 0.05$ ) at age between diploids and triploids (Wilcoxon rank sum).**

Variable	Diploids	Triploids
Growth: mean weight (g) ± SE (N)		
Age (months)		
2	4.41 <sup>a</sup> (72)	4.43 <sup>a</sup> (72)
4	40.6 ± 2.39 (70)	40.7 ± 2.11 (70)
8	87.8 ± 1.09 (70)	92.9 ± 0.98 (70)*
13	304.9 ± 17.4 (40)	357.8 ± 25.9 (40)*
16	401.7 ± 39.9 (15)	466.0 ± 63.0 (15)*
Feed conversion		
Total fish weight gained (14 mo) <sup>b</sup>	20.08 kg	22.20 kg
Total feed given (14 mo)	26.10 kg	26.40 kg
Feed conversion	1.30	1.19

<sup>a</sup>All fish were weighted as a group.

<sup>b</sup>Total gain includes fish that died or were removed for chromosome counts.

1.30 (Table 1). Further studies are needed to assess comparative growth rates in ponds.

Mature diploid male channel catfish have the tertiary sexual characteristics of broad muscular heads and dark coloration. The sex of both male and female diploid catfish can be discerned rather easily. Tertiary sex characteristics are not as evident in triploid males, and it is difficult to sex triploid males and females externally. Experimental data has shown no significant difference from a 1:1 sex ratio ( $P > 0.99$ ) (Wolters et al. 1982a).

The testis of diploid channel catfish has anterior and posterior regions based on the appearance of fingerlike projections of the surface. The anterior region (three-fourths of the testis) has large, thick, white projections. This region contains coiled seminiferous tubules where spermatogenesis occurs. Projections of the posterior region are pink and generally fused into a single mass (Sneed and Clemens 1963; Grizzle and Rogers 1976). The testes of triploid catfish at 8 months of age have been found to be smaller than those of diploid catfish, and macroscopic differences between anterior and posterior regions are less distinct. In histological sections, the seminiferous tubules of diploid testes have spermatogenic epithelium composed of 2-3 cell layers. Most cells had interphase nuclei, but only a few cells appeared to be in active division. The large lumina of the tubules are filled with many spermatozoa. The spermatogenic epithelium of triploid testes was found to be much thicker with a variable number of cell layers. Many cells were undergoing active division. The lumina of the tubules were smaller and contained no spermatozoa.

Diploid ovaries in catfish at 8 months of age were found to be 3-4 times larger than triploid ovaries. Numerous developing oocytes were macroscopically visible in the ovaries of diploid catfish, whereas in triploids only an occasional oocyte could be seen. Diploid ovaries examined in histological sections contained many primary oocytes having strongly basophilic cytoplasm and lightly staining nuclei. Many large, maturing oocytes were also present and could be identified by their large, irregular nuclei and vacuolated cytoplasm associated with yolk formation. Sections of triploid ovaries contained small cells that were all of similar size. Many of the cells were undergoing active division. Occasionally a larger, apparently developing, oocyte could be found (Wolters et al. 1982a).

## Potential benefits to commercial culture

The faster growth rate demonstrated by triploid catfish in tank culture would be very beneficial in commercial pond culture. Faster growing fish obviously reach market size faster, resulting in a savings in labor and greater production per unit of time. Better feed conversion in triploids possibly resulting from the sterile condition yields savings in feed costs. Feed costs can be 51-57% of the annual operating costs for catfish production (Waldrop and Smith 1980). Triploid catfish with 8% better feed conversion than diploids would significantly lower feed costs (Wolters et al. 1982a).

The most significant benefit to commercial production from triploid catfish may occur during processing. Reduced gonad development results in less wastage in processing. Preliminary data from processed triploid catfish have shown an average of 6% higher dress-out percentage over diploids (Wolters et al. unpubl.). Average prices in July 1983 were \$1.57/lb. for frozen fish. An increase in dress-out percentage of only 1% would have increased processed weight by 300,000 kg (700,000 lb.) for the first 6 months of 1983, with a value of \$1.1 million to the industry.

## CITATIONS

- ALLEN, S. K., Jr., and J. G. STANLEY.  
1978. Reproductive sterility in polyploid brook trout, *Salvelinus fontinalis*. Trans. Am. Fish. Soc. 107:473-478.
- BARDACH, J. E., J. H. RYTHER, and W. O. McLARNEY.  
1972. Aquaculture; the farming and husbandry of freshwater and marine organisms. John Wiley and Sons, New York.
- CUELLAR, O., and T. UYENO.  
1972. Triploidy in rainbow trout. Cytogenetics (Basel) 11:508-515.
- DUPREE, H. K., O. L. GREEN, and K. E. SNEED.  
1969. Techniques for the hybridization of catfishes. Publ. 221, U.S. Fish Wildl. Serv., Southeast. Fish Cult. Lab., Marion, Alabama.
- FANKHAUSER, G.  
1945. The effects of changes in chromosome number on amphibian development. Q. Rev. Biol. 20:20-78.
- GERVAI, J., S. PETER, A. NAGY, L. HORVATH, and V. CSANYI.  
1980. Induced triploidy in carp, *Cyprinus carpio* L. J. Fish Biol. 17:667-671.
- GOLD, J. R., and J. C. AVISE.  
1976. Spontaneous triploidy in the California roach *Hesperoleucis symmetricus* (Pisces:Cyprinidae). Cytogenet. Cell Genet. 17:144-149.
- GRIZZLE, J. M., and W. A. ROGERS.  
1976. Anatomy and histology of the channel catfish. Auburn Univ. Agric. Exp. Stn., Auburn, Alabama.
- HOLLENBECK, P. J., and C. L. CHRISMAN.  
1981. Kidney preparations for chromosomal analyses of Ictaluridae. Copeia 1981:216-217.
- JENSEN, J., R. DUNHAM, and J. FLYNN.  
1983. Producing channel catfish fingerlings. Circ. ANR-327, Coop. Ext. Serv., Auburn Univ., Auburn, Alabama.
- KLIGERMAN, A. D., and S. E. BLOOM.  
1977. Rapid chromosome preparations from the solid tissue of fishes. J. Fish. Res. Board Can. 34:266-269.
- MEYER, F. P., K. E. SNEED, and P. T. ESCHMEYER, (editors).  
1973. Second report to the fish farmers; the status of warmwater fish farming and progress in fish farming research. U.S. Bur. Sport Fish. Wildl. Res. Publ. 113.
- PURDOM, C. E.  
1969. Radiation-induced gynogenesis and androgenesis in fish. Heredity 24: 431-444.  
1972. Induced polyploidy in plaice (*Pleuronectes platessa*) and its hybrid with the flounder (*Platichthys flesus*). Heredity 29:11-24.  
1976. Genetic techniques in flatfish culture. J. Fish. Res. Board Can. 33:1088-1093.
- SMITHERMAN, R. O., H. M. EL-IBIARY, and R. E. REAGAN, (editors).  
1978. Genetics and breeding of channel catfish. South. Coop. Ser. 223, Alabama Agric. Exp. Stn., Auburn Univ., Auburn.
- SNEED, K. E., and H. P. CLEMENS.  
1963. The morphology of the testes and accessory reproductive glands of the catfishes (Ictaluridae). Copeia 1963:606-611.
- SWARUP, H.  
1959a. Production of triploidy in *Gasterosteus aculeatus* (L.). J. Genet. 56:129-142.  
1959b. Effect of triploidy on the body size, general organization and cellular structure in *Gasterosteus aculeatus* (L.). J. Genet. 56:143-155.
- THORGAARD, G. H., and G. A. E. GALL.  
1979. Adult triploids in a rainbow trout family. Genetics 93:961-973.
- VALENTI, R. J.  
1975. Induced polyploidy in *Tilapia aurea* (Steindachner) by means of temperature shock treatment. J. Fish. Biol. 7:519-528.
- WALDROP, J. E., and R. D. SMITH.  
1980. An economic analysis of producing pond-raised catfish for food in Mississippi: A January 1980 update. Res. Rep. 103, Miss. Agric. For. Exp. Stn., Miss. State, MS.
- WOLTERS, W. R., C. L. CHRISMAN, and G. S. LIBEY.  
1981a. Lymphocytes culture for chromosomal analyses of channel catfish, *Ictalurus punctatus*. Copeia 1981:503-504.  
1982b. Erythrocyte nuclear measurements of diploid and triploid channel catfish, *Ictalurus punctatus*. J. Fish. Biol. 20:253-258.
- WOLTERS, W. R., G. S. LIBEY, and C. L. CHRISMAN.  
1981b. Induction of triploidy in channel catfish. Trans. Am. Fish. Soc. 110:312-314.  
1982a. Effect of triploidy on growth and gonad development of channel catfish. Trans. Am. Fish. Soc. 111:102-105.





# An Investigation of Potential Ovulatory Stimuli for the Bullfrog *Rana catesbeiana*

DUDLEY D. CULLEY

KIRK A. EASLEY

LYNN DENSON

BARBARA A. CARR

M. ARIF OTHMAN

*School of Forestry, Wildlife, and Fisheries  
Louisiana Agricultural Experiment Station  
Louisiana State University Agricultural Center  
Baton Rouge, Louisiana 70803*

## ABSTRACT

*Rana catesbeiana* pituitaries and progesterone and a synthetic gonadotropin releasing hormone (Gn-RH) agonist proved to be an effective and consistent ovulatory stimuli for the bullfrog. Mammalian gonadotropins, pituitary homogenates from other anurans, and gonadotropin-releasing hormone (LH/FSH-RH) failed to elicit ovulation, but further documentation is warranted. Bullfrogs with mature ovaries were observed throughout the year from south Louisiana populations and were ovulated by hormonal injection. Use of pituitaries taken from wild populations captured during the spring, summer, and fall were equally effective in producing an ovulatory response, as were pituitaries taken from laboratory-cultured females. Female pituitaries appeared a more potent inducer of ovulation than male pituitaries. Females force-fed a prepared diet were successfully ovulated after 8 and 12 weeks of feeding. Laboratory-reared females maintained under standard laboratory conditions (12L:12D, 25 ± 1°C) were ovulated as early as 6 months postmetamorphosis and as late as 34 months postmetamorphosis.

## INTRODUCTION

Although the bullfrog *Rana catesbeiana* is widely used as a laboratory animal, culture techniques have not been developed and implemented, with the exception of efforts by our laboratory. Lack of reproductive control, the inability of most laboratories to provide the required food to the postmetamorphic stages, inadequate housing, improper environmental conditions, poor sanitation, and lack of disease control have been major obstacles to developing colonies of bullfrogs for teaching and research, or mass culture for education and human consumption.

In recent years considerable progress at the Louisiana State University Amphibian Laboratory has been achieved in developing techniques for continuous culture of this species (Culley et al. 1978). Most noteworthy of this research effort was the recent development of standard techniques to induce spermiation from laboratory-reared or wild-collected bullfrogs (Easley et al. 1979). However, control of ovarian recrudescence and ovulation has remained problematic.

Basic procedures for induction of ovulation in anurans with homoplastic pituitary injections and subsequent artificial fertilization of extruded eggs have been outlined by Rugh (1965), di Bernardino (1967), and the National Academy of Sciences (NAS 1974) with the methodology resulting from studies by Rugh (1935), Wright (1961), and Wright and Flathers (1961). Although these techniques of artificially ovulating wild-caught anurans are frequently used on the bullfrog, ovulation is seldom achieved. Rugh (1935) treated two female bullfrogs obtained during the breeding season with high levels of pituitary homogenates and elicited ovulation, though the extent of response was not described. Licht (1974) failed to induce *in vitro* ovulation or maturation by exposing follicles considered to be sexually mature to homologous pituitary extracts, but recently demonstrated an ovulatory response with a gonadotropin-releasing hormone (Gn-RH) agonist (Licht et al. 1982).

Failure of animals to respond to standard laboratory methods could result from a number of factors including (1) poor quality of anurans often supplied to the researcher by the commercial dealer, (2) improper administration (dosage and frequency of injection) of the hormone(s) used as the ovulatory stimulus, (3) improper environmental regime under which the animals were held prior to treatment, (4) lack of feeding which is often indicative of asynchronous ovarian development, (5) injection of hormones without regard to a possible circadian rhythm of sensitivity, and (6) inability to select frogs which possess a mature complement of oocytes capable of undergoing maturation and ovulation in response to an appropriate hormonal stimulus.

Several of these factors, including photoperiod, temperature, and the circadian injection scheme, have been shown to have a regulatory effect on reproductive development and sensitivity of the bullfrog (Horseman et al. 1978; Penkala 1978; Easley et al. 1979). Even subtle disturbances such as the time of day the animals are fed or handled and their tanks cleaned can cause cumulative changes in hormonal or physiological conditions of anurans (Meier et al. 1973; Horseman et al. 1976; Licht et al. 1983; Mbangkollo and DeRoos 1983).

Studies by Horseman et al. (1978) indicated that an environmental regime consisting of a 12L:12D photoperiod and 25 ± 1°C air and water temperature prevented appreciable ovarian regression and atresia in either laboratory-reared or wild caught laboratory-conditioned bullfrogs. Furthermore, this regime was conducive to maintenance of normal gonadal condition in females under long-term laboratory conditions (Culley et al. 1982). Apparently cyclic

environmental zeitgebers are not absolutely essential for normal ovarian development, at least during the initial wave of reproductive development or recrudescence; we have consistently ovulated females collected throughout the year and held in the laboratory for several months before inducing ovulation, as well as females cultured under cyclic temperature and photoperiod conditions.

This paper describes work completed on identifying environmental factors that affect ovulation, and testing of potential ovulatory stimuli other than bullfrog pituitaries and progesterone.

This work is part of a continuing effort by this laboratory to develop standard techniques for laboratory or commercial culture of the bullfrog. The depletion and poor quality of wild bullfrog stocks threatens the continued use of these animals which have played a very important role in biomedical research and teaching (Culley 1973; NAS 1974), and are widely utilized as human food.

## MATERIALS AND METHODS

Laboratory-reared female bullfrogs utilized in this study were either collected as eggs or larvae from research ponds at the Louisiana Agricultural Experiment Station Ben Hur Biological Research Area (Baton Rouge, Louisiana), or from eggs fertilized within the laboratory in accordance with methods outlined by di Berardino (1967) or McKinnell et al. (1976). The larvae were fed a prepared diet and maintained in a rearing system as reported by Culley et al. (1977). After forelimb emergence, frogs were reared in fiberglass tanks designed by Culley (1976). Each tank was cleaned and frogs fed daily, usually during the afternoon. Juvenile frogs were fed almost exclusively mosquitofish (*Gambusia affinis*), whereas the diet of frogs weighing more than 100 grams was supplemented with other fish species, crawfish, and tadpoles. All animals (larvae, juveniles, and adults) were maintained on a 12-hour daily photoperiod (0600-1800 CST) with a light intensity within rearing containers of approximately 100 to 200 lux. Water and air temperature was  $25 \pm 1^\circ\text{C}$ .

Wild collected female bullfrogs used in the tests were purchased throughout the year from Gulf South Biological Inc. (Ponchatoula, Louisiana), Jacque Weil Co. (Rayne, Louisiana) and Davis Farms (Clovis, California). These animals were subjected to the same feeding and rearing regimes provided laboratory-reared stock when injections were not initiated immediately after purchase from a supplier.

Previous studies showed that ovarian condition influenced ovulatory response, and females could not be selected at random for determining the effect of hormone injections on ovulation (Culley et al. 1982). These initial studies were reported by Othman (1978) who showed that an ovulatory response could rarely be obtained unless the oocytes were mature (Stage V) (Table 1). Egg condition for most frogs in this study was determined prior to injections by surgically removing a piece of the ovary (unpubl. data), along with a morphometric index which could be correlated to ovarian condition (Culley et al. 1982). It has been demonstrated that surgery does not inhibit ovary development or affect ovulation (Carr and Culley, 1984a, b). Ovarian samples to be examined for developmental stage and/or oocyte stage frequencies were fixed in 10% formalin. Each sample was cut into three 5x5 mm fragments, to be analyzed separately for oocyte counts and these values averaged for frequency determinations for a given sample. Ovulation responses were recorded as negative (no eggs released), partial (50-1,000 eggs), or complete (all mature Stage V oocytes stripped from the female). Staging of the ovary (Table 1) followed the schemes developed by Dumont (1972), Kemp (1953), and Penkala (1978).

Table 1—Oocyte stages in *Rana catesbeiana*. Adapted from Penkala (1978).

Stage	Diameter (mm)	
I	$\geq 0.20$	Clear oocytes; nuclei plainly discernible.
IIA	0.20-0.35	Translucent (with nuclei visible) to pale white (early).
IIB	0.35-0.67	Solid white to cream color.
III	0.67-0.83	Light grey to darkly pigmented (melanin deposition occurring).
IV	0.83-1.25	Polarity evident; darkly pigmented animal hemisphere; greyish vegetal hemisphere.
V	1.25-1.50	Last distinct class prior to maturation; polarity highly resolved, with animal hemisphere lighter in color and vegetal hemisphere very white.
VI	Highly variable	Atretic, follicles regressing; evidenced by swollen oocytes with irregular, discolored surfaces, which become highly vascularized and granularized; early-stage oocytes become yellow to orange in color, late stages become brown to black; in late phase, follicles reduced to condensed clump of pigment granules.

## Experiment 1: Condition affecting ovulation

With an effective ovulatory stimulus identified (a combined injection of 2 + *R. catesbeiana* pituitaries and 5 mg progesterone on days 1 and 3), studies were undertaken to define management techniques to enhance reproductive control. Injection procedures followed Culley et al. (1982). Monitoring of ovarian condition was as described above. Controls received injections of distilled water (carrier). The following studies were concluded:

(1) Wild female bullfrogs were collected at various times of the year to determine if ovulation could be induced (normal breeding season for all collection sites was April through August, with the peak occurring in April through June). Arrangements were made with a supplier to collect the animals within a given time (one night) and frogs were either picked up the next day or were shipped to our laboratory within 48 hours. Injection was accomplished within 48 hours after arriving in the laboratory.

(2) Wild bullfrogs not containing a mature complement of oocytes (Stage V) were placed under standard laboratory conditions (12L:12D, 25°C) (Horseman et al. 1978) and provided a continuous supply of crawfish for 8 weeks, or force fed a pelleted diet (Liao 1980) for periods of 4, 8, or 12 weeks.

Final ovarian condition was ranked in accordance with the following scheme: (12) Stage V eggs resulting in complete ovulation; (11) Partial ovulation (50-1,000 eggs ovulated with remaining oocytes mature (Stage V); (10) Stage V oocytes but no ovulation and no atresia; (9) Stage V oocytes with one lesser stage containing atretic oocytes; (8) Stage V oocytes with two egg stages with atretic oocytes; (7) Stage IV oocytes and no atresia; (6) Stage IV oocytes and one stage with atretic eggs; (5) Stage III oocytes; (4) Stage III and atresia; (3) Immature vitellogenic ovaries (Stage II A and II B) without atretic oocytes; (2) Immature vitellogenic ovaries with atresia; (1) Immature previtellogenic ovaries (Stage I).

Bullfrog pituitaries and progesterone were then injected as outlined above.

(3) Laboratory-reared bullfrogs of various ages and sizes were injected to further define the flexibility with which ovulation could be induced. All animals used in the study were cultured from the

egg under conditions as already described. Because growth rates vary, the age from metamorphosis to a condition of mature oocytes varies from 6 to 12 months. However, several frogs undoubtedly had developed a mature complement of oocytes several months before injections (as determined by the morphometric index) (Culley et al. 1982). Four days after injection, the frogs were opened and the most advanced oocyte stage identified (including any ovulated eggs).

### Experiment 2: Testing of other potential ovulatory stimuli

Having established that bullfrog pituitaries and progesterone induce ovulation when the females were placed under, or were received from, a variety of environmental conditions, efforts turned to locating other stimuli for ovulation because bullfrog pituitaries are difficult to obtain. Commercially available preparations were selected in most cases. Treatment schedules and dosages are shown in Table 5. Tests were conducted with both wild and laboratory bullfrogs as in Experiment 1. Controls consisted of carrier solutions, and bullfrog pituitaries and progesterone were also used to document effectiveness. The environmental regime under which the animals were held was as reported above, unless specifically stated otherwise.

All injections were given one hour after the onset of light, with the exception of multiple daily injections of a synthetic mammalian leutinizing hormone/follicle stimulating hormone-releasing hormone (LH/FSH-RH) (National Institute of Health, NIAMDD-ABBOTT Lot 19-192-AC) and a gonadotropin releasing hormone agonist (Gn-RH agonist) (im Bzl-D-His<sup>6</sup>, Pro<sup>9</sup>-Net) (McCreery et al. 1982). *Rana catesbeiana* leutinizing hormone (LH), Mammalian LH (NIH-LH-520), human chorionic gonadotropin (HCG) (Sigma Chemical Co., St. Louis, Missouri), and mixed male and female acetone-dried *Rana pipiens* pituitaries (NASCO, Fort Atkinson, Wisconsin) were injected intraperitoneally. Also injected intraperitoneally were male and female *Rana catesbeiana* pituitaries extracted from laboratory-cultured frogs and purchased heads (from Gulf South Biological Supply Co., Ponchatoula, La, July, August 1979; July 1980; November 1980; March 1981) and progesterone (Sigma Chemical Co., St. Louis, Missouri), using methods reported by de Berardino (1967). LH/FSH-RH was injected into the dorsal lymph sacs.

Attempts to strip eggs were made 24 hours after the initial injection and at subsequent 12-hour intervals for the duration of the injection period. Forty-eight hours after the final injection, frogs were sacrificed by spinal pithing to access ovarian condition.

### Experiment 3: Ovulatory response to a Gn-RH agonist

Work by McCreery et al. (1982) demonstrated the effectiveness of a synthetic gonadotropin releasing hormone agonist [(im Bzl) DHIS<sup>6</sup>, Pro<sup>9</sup>, Net]-Gn-RH. TFA #97-74-10. Daily injections for 3 to 4 days resulted in ovulation of female bullfrogs, and single injections caused spermiation in males.

This experiment was designed to test animals from another population (Louisiana). Ovarian samples were taken prior to injections, and test and control procedures were the same as previously described. Dosages are shown in Tables 3 and 4.

## RESULTS AND DISCUSSION

### Experiment 1

Table 2 shows that ovulation was not limited to wild bullfrogs collected during the peak of the natural breeding season (April through June). Bullfrogs with mature ovaries were observed throughout the year, and eggs were obtained by hormonal injection for all months attempted. Hormone dosages necessary to induce ovulation did not vary seasonally as long as a mature complement of oocytes was present within the ovary (frogs with Stage IV oocytes did not ovulate). The pituitaries used for injections were taken from wild females collected in March, July, August, and September and from laboratory-cultured females (12L:12D regime). The fact that wild bullfrogs with mature oocytes could be obtained all year indicates that some reproductive-related hormonal activity continues, although seasonal changes of gonadotropins and steroids in wild populations are evident (Licht et al. 1983). Laboratory-cultured females held under light conditions other than 12L:12D may also show variation in plasma gonadotropins, as Horseman et al. (1978) demonstrated significant rates of oocyte atresia under light regimes greater and less than 12 hours.

Laboratory-reared females, maintained under standard laboratory conditions from hatching, ovulated in response to injections of bullfrog pituitaries and progesterone as early as six months post-metamorphosis (Table 3). Age of the animal did not appear critical as ovulation was achieved in laboratory animals from 6 to 34 months postmetamorphosis. Offspring from parents with rapid growth characteristics (11 through 18 of Table 3) were maintained on a continuous feeding regime from metamorphosis, attained reproductive maturity, and ovulated 6 to 14 months after metamorphosis. Jorgensen (1967) and Jorgensen et al. (1978) suggested that nutrition is critical in the development and maintenance of vitellogenic oocytes in *Bufo bufo bufo*. Horseman et al. (1978) added that nutritionally healthy animals under proper environmental conditions could maintain a population of mature oocytes for a considerable length of time, which possibly accounts for the wide age interval over which the bullfrog can be ovulated. Our results in this and other studies (Penkala 1978; Othman 1978) suggest that without a stimulatory environmental regime and consistent feeding activity by the animals, ovarian patterns can become acyclic, deviating into patterns of alternating atresia and recrudescence with few of the developing oocytes reaching a postvitellogenic state of maturity.

Table 2—Ovulation responses of wild bullfrogs to *R. catesbeiana* pituitaries and progesterone.

Month and year collected	Collection site <sup>a</sup>	No. animals	Mean body wt. (g)	No. animals with Stage V oocytes	Ovulation response		
					Neg.	Partial	Complete
March 78	R	6	624	2	4	2	0
April 78	R	4	710	2	1	1	2
June 78	R	7	483	4	3	0	4
July 78	R	5	533	2	3	1	1
Aug. 78	P	6	597	4	2	0	4
Sept. 78	R	5	693	0	4	1	0
Oct. 78	R	4	556	0	4	0	0
Nov. 78	R	10	580	1	9	0	1
March 79	C	4	649	3	1	0	3
Oct. 79	P	8	586	4	4	1	3

<sup>a</sup>R = Rayne, Louisiana;

P = Ponchatoula, Louisiana;

C = Clovis, California.

**Table 3—Ovarian condition and ovulation responses of laboratory-reared bullfrogs to *R. catesbeiana* pituitaries and progesterone.**

Frog <sup>a,b</sup>	Age <sup>c</sup> (months)	Total body wt. (g)	Most advanced oocyte stage	Ovulation response
1	10	476	V	Complete
2	7	456	IV	Negative
3	11	309	IV	Negative
4	12	290	IV	Negative
5	12	246	IV	Negative
6	34	686	V	Partial
7	11	336	IV	Negative
8	11	253	V	Negative
9	11	256	IV	Negative
10	11	382	IV	Negative
11	6	381	V	Complete
12	6	365	V	Complete
13	16	370	V	Complete
14	16	362	V	Complete
15	16	280	IV	Negative
16	14	412	V	Partial
17	14	431	V	Partial
18	14	296	V	Partial

<sup>a</sup>Frogs 1-10 were laboratory-reared animals from field collected eggs.

<sup>b</sup>Frogs 11-18 were F<sub>1</sub> laboratory-reared animals from parents selected for rapid growth.

<sup>c</sup>Postmetamorphosis.

Preovulatory wild-collected bullfrogs were brought into a mature ovarian condition with minimal atresia when held under laboratory conditions for eight weeks, either fed crawfish or force fed artificial pellets (Table 4). Growth rates were excellent under both treatments, and ovulation was achieved in all animals injected with bullfrog pituitaries and progesterone after eight weeks.

After only four weeks of force feeding under laboratory conditions, animals were undergoing recrudescence and vitellogenesis (Stage III and IV oocytes). Furthermore, the ovaries contained a group of black, late atretic bodies (Rankings 4 and 6) which probably represented an earlier wave of ovarian recrudescence. After 12 weeks of forced feeding several bullfrogs had apparently completed the ovarian cycle (i.e., the ovary was ready to undergo maturation and ovulation), but when the proper ovulatory stimulus was not received the ovaries evidently began to regress, as was indicated by the swollen oocytes with discolored surfaces (Rankings 9 and 6). The atretic response could have also been enhanced by excessive handling.

## Experiment 2

Both male and female *Rana catesbeiana* pituitaries and progesterone proved to be an effective ovulatory stimulus for the bullfrog (Table 5). Consistent ovulation was achieved with pituitaries from laboratory frogs, and wild frogs collected in March, July, August, and November. These findings concur with the early investigations of Wolf (1929) on *Rana pipiens* and Houssay (1947) on *Bufo arenarum* where anuran ovulation was elicited only by homoplastic pituitary injections of implantations. Simultaneous injections of two female bullfrog pituitaries and 5 mg progesterone on day 1 and day 3 produced consistent ovulatory responses. Two or four male pituitaries with progesterone produced partial ovulation. Progesterone was apparently effective in enhancing pituitary ovulatory ac-

**Table 4—Ovulation responses and ovarian condition of laboratory-reared conditioned wild bullfrogs subjected to a daily feeding of live crawfish for 8 weeks (Treatment D) or force-fed a pellet diet daily for 4, 8, or 12 weeks (Treatments A, B and C, respectively).**

	Body weight (g)			Treat- ment	Animals injected	Ovulation response <sup>a</sup>			Ranking of final ovarian condition
	Initial	after (wks)				N	P	C	
458	467			A					7
410	430			A					6
400	408			A					6
389	391			A					6
390	421			A					4
355	382			A					4
400	438			A					7
350	352			A					7
335	357			A					4
370	392	463		B					10
371	379	478		B					10
451	464	525		B	X			X	12
420	412	482		B					10
417	425	540		B	X		X		11
465	503	551		B	X			X	12
349	360	434		B					7
403	411	492		B					10
360	390	472	506	C	X	X			9
468	466	574	600	C	X	X			9
388	390	481	540	C	X	X			8
497	502	586	682	C	X			X	12
420	424	500	546	C	X	X			6
415	432	555	614	C	X	X			9
355	385	462	492	C					6
402	410	484	498	C					6
375	378	464	504	C					9
412	440	486		D					7
373	405	444		D					6
472	501	590		D	X			X	12
364	410	490		D	X			X	12
504	528	579		D	X			X	12
418	533	601		D	X			X	12
402	412	471		D					7
397	424	454		D					7

<sup>a</sup>N = Negative; P = Partial; C = Complete.

tivity, supporting similar findings by Wright (1961) and Wright and Flathers (1961). In most cases, ovulation was complete 24 to 48 hours after the second injection.

Of the 59 wild-collected bullfrogs injected with female bullfrog pituitaries and progesterone, 24 had mature Stage V oocytes. All 24 of these animals ovulated in response to the injections, with 18 frogs yielding complete ovulation and 6 responding with partial ovulation. Laboratory-reared and laboratory-conditioned wild bullfrogs also responded favorably to the ovulatory stimulus.

No ovulation responses were obtained with HCG, mammalian LH, *R. catesbeiana* LH, or pituitary homogenates from other anurans (Table 5). However, the amphibian LH was available in only small amounts; therefore only nine females, each receiving 20 µg of this hormone/injection, were evaluated. Large doses of HCG (500-1,000 IU) and mammalian LH (2.5 mg) were injected in an attempt to overcome suspected phylogenetic differences in specificity of the mammalian gonadotropins, but without success. These phylogenetic differences are not so distinct in Bufonidae (Houssay 1947; Kjaer 1969; Kjaer and Jorgensen 1971) and Pipidae (Redshaw 1972) where LH and HCG actively induce ovulation, both *in vitro* and *in vivo*. Furthermore, although amphibians appear to respond more readily to homozooic pituitary injections than

**Table 5—Summary of ovulation responses of bullfrogs to various hormonal stimuli.**

N	Animals <sup>a</sup>	Mean body wt. (g)	Treatment	Dosage	Injections		No. animals with Stage V oocytes	Ovulation response <sup>b</sup>		
					No.	Frequency		N	P	C
6	WC	632	Amphibian LH	20 µg	2	Alt. days	4	6	0	0
3	WC	601	Amphibian LH	20 µg	2	Alt. days	2	3	0	0
			Progesterone	5 mg						
4	WC	639	Mammalian LH	2.5 mg	2	Alt. days	2	4	0	0
9	WC	523	HCG	500 IU	3	Daily	3	9	0	0
4	WC	616	HCG	1000 IU	2	Alt. days	3	4	0	0
7	WC	460	HCG (14L:10D)	500 IU	10	Daily	3	7	0	0
7	WC	451	HCG (8L:16D)	500 IU	10	Daily	3	7	0	0
15	WC	490	LH/FSH-RH	10 µg	3	Daily	9	15	0	0
15	WC	525	LH/FSH-RH	50 µg	3	Daily	8	15	0	0
11	WC	530	LH/FSH-RH	100 µg	3	Daily	4	11	0	0
12	LR	277	LH/FSH-RH	10 µg	21	Daily	4	12	0	0
7	WC	641	LH/FSH-RH	100 µg	9	3 × Daily <sup>c</sup>	3	7	0	0
13	LR	286	LH/FSH-RH	10 µg	63	3 × Daily <sup>c</sup>	5	13	0	0
9	WC	436	LH/FSH-RH	2 µg	28	2 × Daily	8	9	0	0
15	LR	236	LH/FSH-RH	2 µg	28	2 × Daily <sup>d</sup>	4	15	0	0
20	WC	585	LH/FSH-RH	10 µg	3	Daily	6	20	0	0
			Progesterone	5 µg						
10	WC	410	LH/FSH-RH	2 µg	4	Daily	6	7	3	0
			<i>R. catesbeiana</i> pituitaries	2 ♀						
9	WC	420	Progesterone	5 mg	3	Daily	8	9	0	0
10	WC	523	<i>R. catesbeiana</i> pituitaries	2 ♀ glands	3	Alt. days	6	10	0	0
13	LR	427	<i>R. pipiens</i> pituitaries	10 glands ♂, ♀	5	Alt. days	4	13	0	0
10	WC	486	<i>R. pipiens</i> pituitaries	10 glands ♂, ♀	2	Alt. days	3	10	0	0
			Progesterone	5 mg						
6	WC	624	<i>R. pipiens</i> pituitaries	10 glands	2	Alt. Days	2	4	2	0
			<i>R. catesbeiana</i> pituitaries	2 ♀ glands						
63	WC	585	<i>R. catesbeiana</i> pituitaries	2 ♀ glands	2	Alt. days	28	35	9	19
			Progesterone	5 mg						
16	LR	413	<i>R. catesbeiana</i> pituitaries	2 ♀ glands	2	Alt. days	9	9	4	3
			Progesterone	5 mg						
8	WC	444	<i>R. catesbeiana</i> pituitaries	2 ♀ glands	2	Alt. days	3	7	1	0
			Progesterone	5 mg						
10	WC	441	<i>R. catesbeiana</i> pituitaries	4 ♂	2	Alt. days	4	7	3	0
			Progesterone	5 mg						
8	F <sub>1</sub> Strain <sup>e</sup>	362	<i>R. catesbeiana</i> pituitaries	2 ♀ glands	2	Alt. days	7	1	3	4
			Progesterone	5 mg						
8	Lab-cond. <sup>f</sup> wild bullfrogs	423	<i>R. catesbeiana</i> pituitaries	2 ♀ glands	2	Alt. days	7	1	0	7
			Progesterone	5 mg						
8	Lab-cond. <sup>g</sup> wild bullfrogs	437	<i>R. catesbeiana</i> pituitaries	2 ♀ glands	2	Alt. days	6	2	6	0
			Progesterone	5 mg						

<sup>a</sup>WC = Wild Collected; LR = Lab-reared  
<sup>b</sup>N = Negative; P = Partial; C = Complete  
<sup>c</sup>Injection time: 0700, 1000, and 1300 hrs.  
<sup>d</sup>Injection time: 0900 and 1500 hrs.  
<sup>e</sup>Laboratory-reared animals from parents selected for rapid growth.  
<sup>f</sup>Held and fed in laboratory two months before injection.  
<sup>g</sup>Second attempt to ovulate the laboratory-conditioned wild bullfrogs (same animals as in f) 8 weeks after the first attempt.

to mammalian gonadotropins, there often appears to be a gonadotropic specificity between genera of anurans. For example, ovulation can be induced readily by injecting homoplastic pituitary homogenates in *Bufo*, but less readily by material from *Leptodactylus ocellatus* and not at all by extracts from *Xenopus* pituitaries (Houssay 1947). The specificity may be more acute in *Rana* as injection of *Rana pipiens* pituitaries and progesterone was not an effective ovulatory stimulus in the bullfrog under conditions of this test (Penkala 1978) (Table 5).

Various combinations of dosage and circadian injection schemes of LH/FSH-RH failed to elicit ovulation from the bullfrog (Table 5). Likewise, simultaneous injection of LH/FSH-RH and progesterone produced negative results. These findings were somewhat surprising in view of the fact that LH/FSH-RH has proven to be an extremely effective stimulus of spermiation in the bullfrog (Easley et al. 1979) and in other anurans (Licht 1974). Although LH/FSH-

RH stimulates gonadotropin secretion in all classes of vertebrates (Peter 1978), there are questions concerning its specificity. Nanogram doses register overwhelming responses in mammals (Schalley et al. 1973); but in studies with fishes and amphibians, massive and frequent doses of LH/FSH-RH were required to induce an ovulatory response (Vellano et al. 1974; Thornton and Geschwind 1974; Lam et al. 1975; Lam et al. 1976). Daniels and Licht (1980) reported that a single injection of LH/FSH-RH stimulated several hundred-fold increases in plasma LH and FSH levels in adult bullfrogs. However, females were less responsive than males to the hormone, and the half-life of the molecule was only 10-20 minutes suggesting that only constant profusion or very frequent injections of the hormone is required to provide an effective ovulatory stimulus. This was demonstrated recently with *R. catesbeiana* (P. Licht, Zoology Dep., Univ. Calif., Berkeley, pers. commun. 1985).

Table 6 points out the importance of injecting bullfrogs with Stage V oocytes. All frogs tested (Table 5) had either Stage IV or V oocytes predominating, and females with Stage IV oocytes were not ovulated by any of the hormones.

### Experiment 3

Tables 7 and 8 show the female ovulatory response to the synthetic Gn-RH agonist that was effective in spermiating male and ovulating female bullfrogs collected in California (McCreery et al. 1982). The hormone also caused ovulation of atretic, stage III, and IV eggs. Attempts to fertilize the stage III, IV, and atretic oocytes were unsuccessful, although Stage V eggs were successfully fertilized. Apparently the agonist is a potent stimulator for ovulation, but not for promoting egg maturation with the dosages used. The agonist is, at present, the most promising material for inducing ovulation in bullfrogs. Currently it is commercially available from Bachem, Inc., Torrance, CA, as LH-RH [Des-Gly<sup>10</sup>, im-Benzyl-D-His<sup>6</sup>, Pro<sup>9</sup>] Nhet (Code PLHR140).

**Table 6—Oocyte stage and ovulatory response of bullfrogs injected with various hormone schemes, irrespective of dose and origin of the frog.**

Hormone injected	No. animals	Ovulation response			
		Stage IV		Stage V	
		No.	Ovulation	No.	Ovulation
LH/FSH-RH	97	52	0	45	0
LH/FSH-RH, progesterone	20	14	0	6	0
LH/FSH-RH, <i>R. catesbeiana</i> pituitaries	10	4	0	6	3
HCG	27	15	0	12	0
<i>R. pipiens</i> pituitaries	13	9	0	4	0
<i>R. pipiens</i> pituitaries and progesterone	10	7	0	3	0
<i>R. pipiens</i> and <i>R. catesbeiana</i> pituitaries	6	4	0	2	2
<i>R. catesbeiana</i> pituitaries and progesterone	122	58	2	64	59
Mammalian LH	4	2	0	2	0
Amphibian ( <i>R. catesbeiana</i> ) LH	9	3	0	6	0

**Table 7—Ovulatory response of wild-caught bullfrogs to various dosages of a synthetic Gn-RH agonist.**

No.	Mean body wt. (g)	Dosage	No. injections	Time (days)	Preinjection <sup>a</sup> oocyte stage	Ovulation response
3	475	2 µg	1/day	2	V	Two partial One complete
3	435	2 µg	4/day	2	V	All complete
2	483	4 µg	4/day	3	V	All complete

<sup>a</sup>Most advanced oocyte stages. All frogs contained Stage I eggs, and a few Stage IIA eggs, a normal condition.

**Table 8—Ovulatory response of wild-caught bullfrogs<sup>a</sup> with different ovarian conditions injected with 3 µg of a synthetic Gn-RH agonist 3×/24 hr for 5 days.**

Frog No.	Body wt. (g)	Preinjection <sup>b</sup> oocyte stage	Ovulatory response by Stage <sup>c</sup>					Postinjection ovary condition and ovulated oocytes
			I	II	III	IV	V	
1	414	IV some atretic	—	—	—	—	—	No change evident
2	432	III, IV, V normal	—	—	—	—	—	No change evident
3	482	III, IV, V some atretic	—	—	P	P	P	Atretic and normal III, IV, V oocytes ovulated; III, IV oocytes in ovary atretic; no Stage V oocytes in ovary.
4	490	III, IV some atretic	—	—	P	P	—	Stage III, IV atretic in ovary, coelomic cavity, oviduct, and ovisac.
5	475	IV normal V some atretic	—	—	P	P	P	Ovulated normal and atretic Stage IV and V eggs, most atretic. Ovary contained normal and atretic Stage IV and V. Ovisac filled with jelly and fluid.
6	524	IV atretic V few present, normal	—	—	—	—	P	Ovulated a few eggs, Stage V. Ovary contained Stage IV atretic eggs.

<sup>a</sup>Collected June, 1981 near Ponchatoula, LA.

<sup>b</sup>See Table 1. Stage I always present; Stages IIA, IIB normally present, but may be absent in recently ovulated females; Stages III, IV, V indicate more advanced stages of ovary development. Normal refers to eggs as defined in Table 1, i.e., diameter, polarity, uniform coloration, spherical shape. Atretic refers to incorrect diameter, poorly defined polarity, mottling coloration, vascularization, non-spherical shape.

<sup>c</sup>Dashes = no ovulation; P = partial ovulation.

## CONCLUSIONS

This study demonstrates the effectiveness of bullfrog pituitaries and progesterone and a synthetic Gn-RH agonist in stimulation of ovulation in bullfrogs. The almost total lack of ovulatory response by females with Stage IV eggs in this study and atretic eggs (Othman 1978) indicate that the injected materials had little effect on stimulating oocyte development. The Gn-RH agonist was a potent ovulator, as even immature and atretic eggs were ovulated. Other materials failed to elicit ovulation, but the lack of response may be related to improper injection schemes.

The ovulation response of females from three different populations (but similar climatic environments) collected at different times of the year indicates that ovulatable females can be obtained from wild populations throughout the year. However, each individual must be evaluated for ovarian condition.

Laboratory-reared females, under proper temperature and photoperiod conditions, can be brought to sexual maturity and maintained in mature condition for an extended period. Wild females with immature ovaries can be brought to full maturity using living or prepared diets within 8 weeks. Use of prepared diets appears to alleviate the need for living food, but the ovulatory response may not be as consistent as when living food is used. The stress of force feeding the frogs daily may have contributed to the reduced response, and was evident for females force-fed for 12 weeks.

## ACKNOWLEDGMENTS

The authors wish to thank Gail Marshall, Joe Penkala, and Tom Graham for technical assistance. This work was supported by the Research Resources Division of the National Institutes of Health (Grant RR00635) and the Louisiana Agricultural Experiment Station. The Gn-RH agonist was provided by Paul Licht, Dept. of Zoology, University of California, Berkeley, and is currently available from Jean E. Rivier, The Salk Institute for Biological Studies, Peptide Biological Laboratory, Box 85800, San Diego, CA 92138.

## CITATIONS

- CULLEY, B. A., and D. D. CULLEY, Jr.  
1984a. The effect of multiple laparotomies, biopsies and feeding on the oocytes of *Rana catesbeiana*. *Aquaculture* 38:329-333.  
1984b. Surgical procedure for collecting ovary samples from *Rana catesbeiana*. *Aquaculture* 38:371-372.
- CULLEY, D. D., Jr.  
1973. Use of bullfrogs in biological research. *Am. Zool.* 13:85-90.  
1976. Culture and management of the laboratory frog. *Lab. Anim.* 5(5):30-36.
- CULLEY, D. D., Jr., N. D. HORSEMAN, R. L. AMBORSKI, and S. P. MEYERS.  
1978. Current status of amphibian culture with emphasis on nutrition, diseases and reproduction of the bullfrog, *Rana catesbeiana*. *Proc. World Maricult. Soc.* 9:653-667.
- CULLEY, D. D., Jr., S. P. MEYERS, and A. J. DOUCETTE, Jr.  
1977. A high density rearing system for larval anurans. *Lab. Anim.* 6:34-41.
- CULLEY, D. D., Jr., A. M. OTHMAN, and K. A. EASLEY.  
1982. Predicting ovulation in the frog, *Rana catesbeiana*, by morphometry. *J. Herpetol.* 16(3): 311-314.
- DANIELS, E., and P. LICHT.  
1980. Effects of gonadotropin - releasing hormone on the levels of plasma gonadotropins (FSH and LH) in the bullfrog, *Rana catesbeiana*. *Gen. Comp. Endocrinol.* 42:455-463.
- di BERARDINO, M. A.  
1967. Frogs. In F. H. Witt and N. K. Wessels (eds.), *Methods in developmental biology*. Thomas Y. Crowell Co., New York.
- DUMONT, J. W.  
1972. Oogenesis in *Xenopus laevis* Daudin. I. Stages of oocyte development in laboratory maintained animals. *J. Morphol.* 136:153-180.
- EASLEY, K. A., D. D. CULLEY, N. D. HORSEMAN, and J. E. PENKALA.  
1979. Environmental influences on hormonally induced spermiation of the bullfrog, *Rana catesbeiana*. *J. Exp. Zool.* 207:407-416.
- HORSEMAN, N. D., A. H. MEIER, and D. D. CULLEY, Jr.  
1976. Daily variations in the effects of disturbance on growth, fattening and metamorphosis in the bullfrog (*Rana catesbeiana*) tadpole. *J. Exp. Zool.* 198: 353-357.
- HORSEMAN, N. D., C. A. SMITH, and D. D. CULLEY, Jr.  
1978. Effects of age and photoperiod on ovary size and condition in bullfrogs (*Rana catesbeiana* Shaw). *J. Herpetol.* 112(3):287-290.
- HOUSSAY, B. A.  
1947. La foncion sexual del sapo *Bufo arenarum* Hensel. *Ann. Acad. Nac. Cienc. Buenos Aires* 12:103-124.
- JORGENSEN, C. B.  
1967. Influence of nutritional state on oocyte growth in the toad ovary. *Gen. Comp. Endocrinol.* [Abstr.] 9(90):462.
- JORGENSEN, C. G., K. E. HEDE, and L. O. LARSEN.  
1978. Environmental control of annual ovarian cycle in the toad *Bufo bufo* L.: Role of temperature. In Assemmacher, I., and Farner, D. S. (eds.), *Environmental endocrinology*, p. 28-36. Springer-Verlag, Berlin Heidelberg.
- KEMP, N. E.  
1953. Synthesis of yolk in oocytes of *Rana pipiens* after induced ovulation. *J. Morphol.* 92:487-511.
- KJAER, K.  
1969. The effect of gonadotropins on oocyte growth in the toad, *Bufo bufo*. *Gen. Comp. Endocrinol.* 13:512-513.
- KJAER, K., and C. B. JORGENSEN.  
1971. Effects of mammalian gonadotropins on ovary in the toad *Bufo bufo* (L.). *Gen. Comp. Endocrinol.* 17:424-431.
- LAM, T. J., S. PANDEY, and W. S. HOAR.  
1975. Induction of ovulation in goldfish by synthetic luteinizing hormone-releasing hormone (LH-RH). *Can. J. Zool.* 53:1189-1192.
- LAM, T. J., S. PANDEY, Y. NAGAHAMA, and W. S. HOAR.  
1976. Effect of synthetic luteinizing hormone-releasing hormone (LH-RH) on ovulation and pituitary cytology of the goldfish *Carassius auratus*. *Can. J. Zool.* 54:816-824.
- LIAO, A.  
1980. Fabrication of amphibian diets using Louisiana shrimp and crawfish wastes with selected binders. Masters thesis, La. State Univ., Baton Rouge, 77 p.
- LICHT, P.  
1974. Induction of sperm release in frogs by mammalian gonadotropin-releasing hormone. *Gen. Comp. Endocrinol.* 23:352-354.
- LICHT, P., B. R. McCREERY, R. BARNES, and R. PANG.  
1983. Seasonal and stress related changes in plasma gonadotropins, sex steroids, and corticosterone in the bullfrog, *Rana catesbeiana*. *Gen. Comp. Endocrinol.* 50:124-145.

- MGANGKOLLO, D., and R. DeROOS.  
1983. Comparative effects of epinephrine, norepinephrine, and a gentle handling stress on plasma lactate, glucose, and hematocrit levels in the American bullfrog (*Rana catesbeiana*). *Gen. Comp. Endocrinol.* 49:167-175.
- McCREERY, B. R., P. LICHT, R. BARNES, J. E. RIVIER, and W. W. VALE.  
1982. Actions of agonistic and antagonistic analogs of gonadotropin releasing hormone (Gn-RH) in the bullfrog *R. catesbeiana*. *Gen. Comp. Endocrinol.* 46:511-520.
- McKINNELL, R. G., D. J. PICCIANA, and R. E. KREIG.  
1976. Fertilization and development of frog eggs following repeated spermiation induced by human chorionic gonadotropin. *Lab. Anim. Sci.* 26(6):932-935.
- MEIER, A. H., T. N. TROBEC, H. G. HAYMAKER, R. MacGREGOR III, and R. C. RUSSO.  
1973. Daily variations in the effects of handling on fat stores and testicular weights in several vertebrates. *J. Exp. Zool.* 184:281-287.
- NATIONAL ACADEMY OF SCIENCES.  
1974. *Amphibians: Guidelines for the breeding, care and management of laboratory animals.* Subcommittee on Amphibian Standards, ILAR (NAS/NRC), Wash., D.E., 153 p.
- OTHMAN, M. A. B.  
1978. Characterization and control of reproductive conditions of the female bullfrog. M.S. Thesis. School of Forestry and Wildlife Management, Louisiana State University, Baton Rouge, 87 p.
- PENKALA, J. E.  
1978. Some environmental and endocrine factors regulating ovarian cycling in *Rana catesbeiana*. M.S. Thesis. School of Forestry and Wildlife Management, Louisiana State University, Baton Rouge.
- PETER, R. R.  
1978. Regulating mechanisms of the anterior pituitary. *In* Gaillaro, P. J., and Boer, H. H. (eds.), *Comparative endocrinology*, p. 341-352. Elsevier, North-Holland.
- REDSHAW, M. R.  
1972. The hormonal control of the amphibian ovary. *Am. Zool.* 12:289-306.
- RUGH, R.  
1935. Pituitary-induced sexual reactions in Anura. *Biol. Bull. (Woods Hole)* 68:74-81.
- RUGH, R.  
1965. *Experimental embryology: Techniques and procedures*, 3rd ed. Burgess, Minneapolis, 501 p.
- SCHALLY, A. V., A. ARIMURA, and A. J. KASTIN.  
1973. Hypothalamic regulatory hormones. *Science* 199:341-350.
- THORNTON, V. F., and I. I. GESCHWIND.  
1974. Hypothalamic control of gonadotropin release in Amphibia: Evidence from studies of gonadotropin release *in vitro* and *in vivo*. *Gen. Comp. Endocrinol.* 23:294-301.
- VELLANO, C., A. BONA, and V. MAZZI.  
1974. The effect of synthetic luteinizing hormone-releasing hormone on ovulation in the crested newt. *Gen. Comp. Endocrinol.* 24:338-340.
- WOLF, O. M.  
1929. Effect of daily transplants of anterior lobe of the pituitary on reproduction of the frog (*Rana pipiens* Shreber). *Anat. Rec.* 44:206.
- WRIGHT, P. A.  
1961. Induction of ovulation *in vitro* in *Rana pipiens* with steroids. *Gen. Comp. Endocrinol.* 1:20-23.
- WRIGHT, P. A., and A. R. FLATHERS.  
1961. Facilitation of pituitary induced frog ovulation by progesterone in early fall. *Proc. Soc. Exp. Biol. Med.* 106:346-347.



# Treatment of Fish Hatchery Water for Solids and Turbidity Removal

THOMAS B. LAWSON

*Agricultural Engineering Department  
Louisiana Agricultural Experiment Station  
Louisiana State University Agricultural Center  
Baton Rouge, Louisiana 70803*

## INTRODUCTION

---

Hatchery systems are primarily of two types: Single pass and recirculating or reconditioning systems. In single-pass systems the water enters the hatchery, is used once and discharged. In recirculating systems the used water is filtered and purified in one or more ways and reused for such purposes as broodstock maintenance or rearing of juveniles. From 90 to 95% of the water is reused in recirculating systems, the other 5-10% made up from fresh water.

In site selection for a fish hatchery, one of the prime considerations is a reliable year-round source of good quality water: free of pollutants and disease organisms, high in oxygen, within the temperature range of the organism being cultured, and containing a minimum of solid and organic material. The purity of the water is important in reducing the costs of treating incoming water and decreasing overall operating costs of the hatchery. With single-pass systems the water may only need to be treated once or twice if treatment of effluent is required. With recirculating systems the problem is compounded. Incoming as well as reused water may require treatment and, in many cases, the effluent may require treatment.

Ever increasing pollution problems make it more difficult to locate sources of good quality water for hatcheries. For site development of cold-water fish hatcheries (trout and salmon), one may still find sources of relatively pure mountain water in the Pacific Northwest region of the United States. These water sources may require little or no treatment for once-through systems. For most hatchery-reared species, however, particularly brackish water and warm-water species, locating a source of good quality water may be a difficult task. Coastal waters are becoming more polluted from industry, sewage treatment plants, power plants, marine oil spills, and agricultural runoff. Freshwater bodies such as lakes and rivers, often suffer from one or more pollution sources.

## WATER SOURCES

---

Water for hatcheries may come from one source or from a combination of several sources including coastal seawater, lakes, rivers, wells or ponds.

### Seawater

The hatchery culture of marine or brackish water species is often hindered by the fact that it is difficult to locate a coastal site that is not affected by some type of pollution. Once-productive coastal areas in the United States are affected more and more by pollution in the form of industrial wastes, sewage, and oil spills. The location of a suitable coastal hatchery site is further complicated by the system of permits and bureaucratic "red tape" that one must go through in order to locate a hatchery in a coastal region.

It is possible that a hatchery could be developed inland for the culture of marine organisms such as oysters and clams through the use of commercially available artificial sea salts; this, however, would be feasible only on a small scale. The expense of using artificial sea salts on a large scale would be prohibitive.

### Lakes

Lakes are usually a good source of water, although they are often affected by pollution sources, either urban, industrial or agricultural.

In addition, lakes and reservoirs often harbor fish disease organisms and contain enough nutrients to promote excessive algal growth. They also present temperature problems in many cases, due to the rise and fall of a thermocline at different times of the year. Intakes from lakes should be screened to remove trash, small fish, and eggs.

### Rivers and Streams

Rivers and streams are often subject to extreme fluctuations in flow, and may carry considerable amounts of debris which must be screened out at the intake. The water also may contain large amounts of silt which must be settled out before it reaches the hatchery. Water from rivers and streams may also contain pollutants, excess nutrients, and disease organisms, thus requiring extensive screening and filtering in addition to disinfection.

### Wells

Water for hatcheries may come from deep or artesian wells, or springs. Deep wells require pumping and often contain nitrogen gas, hydrogen sulfide, carbon dioxide or other gases which must be removed before the water can be used. Groundwater may contain pollutants or toxic substances such as arsenic, iron, insecticides, and herbicides. In addition, groundwater is usually very low, or completely devoid, in oxygen and must be aerated before use.

### Ponds

Ponds are often a good source of high quality water since the user generally has control over what goes into the pond. However, ponds may sometimes suffer the same fate as lakes and may receive pollution in the form of silt from shoreline erosion or chemicals from agricultural runoff. Nutrients from agricultural areas often cause excessive algal blooms. In addition, if fish are present in the water supply pond, they may keep the water stirred up so that the water is excessively turbid. High levels of turbidity are generally not harmful to fish except in exceptionally high concentrations; but turbidity does limit spawning somewhat, and it also hinders egg development.

### Recycled water

In a strict sense, water which has been reconditioned and recycled may be considered a water source. It is often feasible to justify the added expense of reconditioning water for reuse, and in many cases the same water may be recycled as many as ten times before it is discharged (Piper et al. 1982). Water may be recycled for a variety of reasons: The quantity of source water may be insufficient, or the quality may not come up to the desired standards. The cost of treating hatchery effluents is reduced considerably when the same water is used several times before discharge. Continuous quality control and sterilization of fresh incoming water may be expensive (Piper et al. 1982).

## CLASSIFICATION OF SOLIDS

The subject of this paper is the removal of solids and turbidity from fish hatchery water. Removal of various types of solid particles and turbidity from water before it enters the hatchery is important in reducing the expense involved in providing a good quality environment in which cultured organisms can grow.

In order to better understand the processes involved in removing solids and turbidity from water, a discussion of the classification of solids is necessary.

### Screenable solids

For lack of a better term, those solids such as twigs, branches, and stones which are large enough to be removed by some type of screening device are referred to as "screenable solids." Sticks, stones, and other forms of large solid materials may damage pumping equipment and clog pipes and water lines. These objects should be removed at the water intake.

### Total solids

Analytically, the total solids content of water is defined as the matter that remains as residue upon evaporation at 103 to 105°C (Metcalf and Eddy 1972). The material referred to as screenable solids is not generally determined by analytical methods; therefore, this material is not included in the category of total solids. Classification of particle sizes for analytical determinations are summarized in Figure 1.

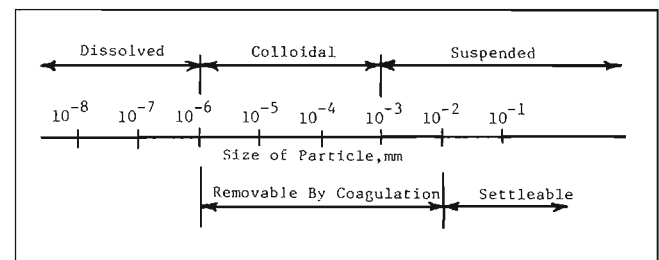

Figure 1—Classification and size range of particles found in water (Metcalf and Eddy 1972).

### Suspended solids

Suspended solids are those having a particle diameter >0.001 mm (Metcalf and Eddy 1972). This includes solids which will settle out in an Imhoff cone within a 60-minute time period. Settleable solids are those having a particle diameter >0.01 mm (see Fig. 1). Those suspended solids having a particle diameter between 0.01 and 0.001 mm will not settle and must be removed from water by other means.

## Colloidal solids

Colloidal solids are those classified as having a particle diameter between 0.001 and 0.000001 mm (Fig. 1). The colloidal fraction cannot be removed by settling and must be removed from water by coagulation, chemical precipitation, biological filtration, or other means.

## Dissolved solids

Dissolved solids are those classified as having a particle diameter <0.000001 mm (Fig. 1). The dissolved solids consists of both organic and inorganic ions and molecules that are present in solution in the water. These may include metals such as copper, iron, and zinc, toxic organic molecules of herbicides and insecticides, un-ionized ammonia, and other substances harmful to fish.

## Turbidity

Turbidity is a measure of the light-scattering properties of water. Colloidal particles, matter suspended in the water, and algae generally all contribute to turbidity. Turbidity may be present in water from any source, while larger particles such as silt may be present only in rivers and streams.

The most common method of reporting turbidity is in Jackson Turbidity Units (JTU's). One JTU = 1 mg/L of turbidity as measured on a silica scale. Silica was chosen as the means to express turbidity with 1 mg/L of SiO<sub>2</sub> equivalent to one unit of turbidity (Sawyer and McCarty 1978).

## EFFECTS OF SOLIDS AND TURBIDITY

Relatively large quantities (500 to 1000 mg/L) of suspended material may be tolerated by fish for short periods of time with minimal effects; however, long-term exposure to certain types of suspended material may cause clubbed gills in some species (Bell 1973). Fish culturists have noted evidence of gill irritation in trout and salmon fingerlings held in turbid water, and this is considered a common avenue of infection by fungi and pathogenic bacteria (Bell 1973).

Fine materials such as silt are detrimental to hatcheries since they may coat eggs, thus reducing or eliminating the necessary oxygen exchange. Salmonid eggs may suffer mortalities up to 85% if 15-20% of the void spaces between eggs are filled with sediment (Bell 1973). This smothering effect may also promote development of fungus on the eggs. Silt and other fine settleable material must be removed from hatchery water before it enters the hatchery.

Turbidity may result from industrial or domestic waste discharges or it may be caused by living organisms including phytoplankton and zooplankton. Turbidity caused by plankton is generally desirable in growout ponds, but algae should not be allowed to enter the hatchery since it will clog pumping and piping systems or filters. Turbidity resulting from humic substances is generally not harmful to fishes, but such waters usually have low pH, low nutrient levels, and limited light penetration ability for photosynthesis (Boyd 1982).

Turbidity resulting from suspended clay particles is extremely undesirable. This type of turbidity occurs to a large extent in ponds, such as in South Louisiana, due to the high clay content of the soil.

Behavioral changes occur in fish exposed to clay turbidities >20,000 mg/L, and appreciable mortalities result when clay turbidity reaches 175,000 mg/L (Boyd 1982).

Other harmful effects of high turbidity are the diminished oxygen-holding capacity of the water and the difficulty of water disinfection. This second point is especially apparent where ultraviolet (UV) radiation is used to disinfect water. The lethal dosage of UV radiation required to kill microorganisms in water is a function of several factors: microorganism species, water depth (or thickness of water film), turbidity, and exposure time (Wheaton 1977). Turbidity not only reduces light penetration into the water, it also shelters organisms from exposure to UV light.

## SOLIDS AND TURBIDITY REMOVAL

A variety of treatment processes are available to the fish culturist for the removal or reduction of solids and turbidity from water. The choice depends largely on such factors as water quality before treatment, degree of required cleanliness, site limitations, and capital investment required.

## Screening

Large objects and particles such as twigs, branches, and stones may easily be removed by a screening process. The screen may be placed over the intake pipe (Figs. 2a and 2b), or a screen or bar rack may be placed within a channel coming into the hatchery (Fig. 3). The screening device may be a simple mesh screen or bar rack which requires periodical hand cleaning, or it may be a more elaborate self-cleaning mechanical bar rack such as used in water treatment or sewage treatment plants. For a complete discussion of screens and bar racks, the reader is referred to Metcalf and Eddy (1972) and Wheaton (1977).

Stationary screens are seldom used to trap particles <1.5 to 3 mm diameter (Wheaton 1977). Rotating microscreens may be used to remove particles as small as 5 μ (Piper et al. 1982).

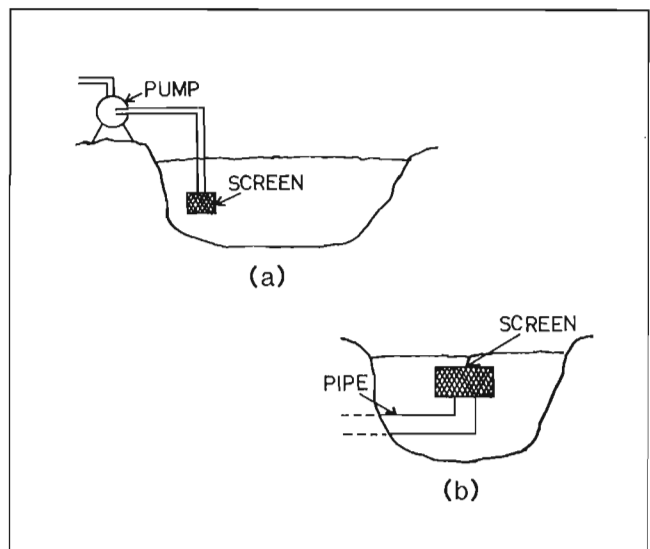

Figure 2—Screens over intake to (a) pump and (b) pipe.

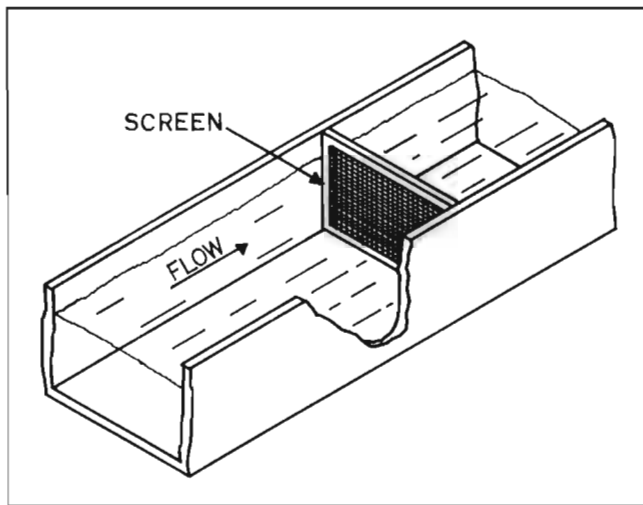

Figure 3—Fixed screen across a channel.

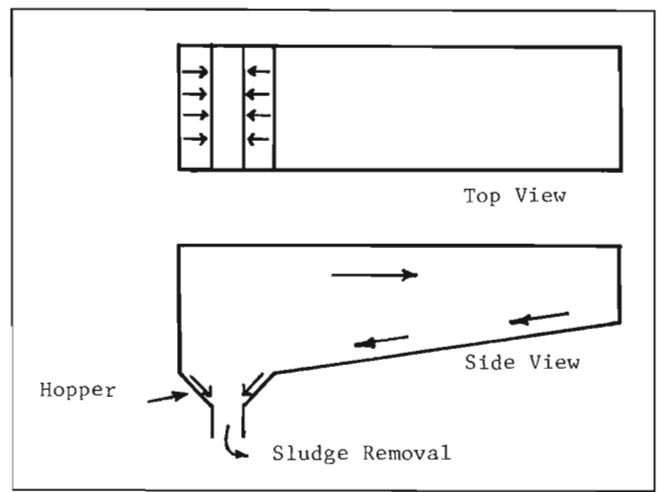

Figure 4—Horizontal rectangular sedimentation basin.

## Sedimentation

Particles too small to be screened, such as pebbles and sand, having a density greater than water may be removed readily by allowing them to settle by gravity in still or slowly moving water in a sedimentation basin or “grit chamber.” There is an unlimited number of basin design configurations from which the culturist may choose, but the horizontal rectangular basin, with or without self-cleaning devices (Fig. 4), is probably the most widely used (Wheaton 1977). Grit chambers, as they are known in the wastewater treatment industry, are basins in which larger, more dense particles will settle out within a short period of time. Generally a retention time of 15 to 60 minutes is sufficient to settle out the larger particles (Bell 1973; Liao et al. 1972). Therefore, basins must be designed to provide the particle with the proper amount of time to settle. For example, if the water flow rate is 100 m<sup>3</sup>/minute, then a basin having a volume of 6,000 m<sup>3</sup> is required to provide a retention time of 60 minutes.

For very small particles, a settling time of several days or weeks is often required. Therefore, land space must be available to provide large enough settling basins, or else some other means of removal must be available.

Sedimentation basins are generally divided into four zones or areas (Fig. 5): inlet area; settling area where particles settling occurs; sludge area where settled particles accumulate; and outlet area. The inlet and outlet areas are separated from the settling area by baffles to provide a quiet zone in which particles can settle out with a minimum of disturbance. Sedimentation basin effectiveness is strongly influenced by each of the four areas and by interaction between areas. For example, if the water flow rate through the basin is too high, sedimentation will not occur.

Particles with a density less than the water in which they are suspended will not settle out regardless of the time allowed. These particles may be removed by one of two methods: coagulation or chemical precipitation. Coagulation refers to a process in which a gentle mixing action brings several particles into contact with one another. As they clump together, the density of the mass increases until it becomes heavier than water and then the particulate mass will settle. The time required may be several hours or days, depending on the size and density of the particles.

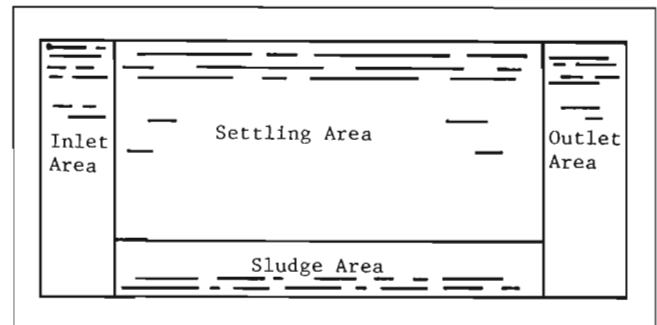

Figure 5—Four areas within settling basin.

In chemical precipitation, a chemical is added to the water which causes the particles to clump together in a mass called a “floc.” The floc then settles out of solution or may be filtered out. The degree of clarification depends upon the amount of chemicals added and the care with which the process is controlled. Through the use of chemical precipitation it is possible to obtain water essentially free from solids in suspension or in the colloidal state (Metcalf and Eddy 1972). In wastewater treatment processes, from 80 to 90% of total suspended solids, 50 to 55% of total organic matter, and 80 to 90% of bacteria may be removed by chemical precipitation (Metcalf and Eddy 1972).

The most commonly used chemicals for precipitation in fish culture water are lime (Ca(OH)<sub>2</sub>) and alum, or aluminum sulfate (Al<sub>2</sub>(SO<sub>4</sub>)<sub>3</sub> · 14H<sub>2</sub>O). However, use of these chemicals may alter the pH of the water somewhat; therefore some control must be maintained on the pH.

## Sand filters

Sand filters consist of a layer of sand or other particulate material through which water flows. Filtering is a mechanical process by which particles too large to pass through the spaces between sand particles are filtered out. The maximum particle size which may pass through the filter is determined by the sand grain size. Generally sand particle sizes vary from 0.02 to 2 mm (Wheaton 1977). By using gravel, rocks, and various shaped plastic media, the particle size removed may be extended upwards.

Sand filters may be classified as slow or rapid (Spotte 1970; Muir 1982; Wheaton 1977). In slow sand filters, the hydraulic loading rate is usually about 0.2 m<sup>3</sup>/m<sup>3</sup> of filter bed per day (Muir 1982). The sand grain size normally varies from 0.3 to 0.4 mm. The smallest particle size removed with the filter is about 30 μ (Spotte 1970), and the depth of the filter bed is usually no more than 0.7 m (Muir 1982). The filter must be cleaned by periodic backwashing or by scraping off the top layer of sand and replacing it with washed sand.

In rapid sand filters, there is generally more than one layer of filter material. Three to five layers of various size particles are commonly used, with the layers arranged in increasing size from the bottom of the filter, with the finest material on top (Fig. 6). The smallest size particle removed by the rapid sand filter is determined by the sand grain size of the uppermost layer, but generally the smallest particle removed is the same as for the slow-rate sand filter, i.e., 30 μ (Spotte 1970).

In rapid sand filters the hydraulic loading rate ranges from 60 to 200 m<sup>3</sup>/m<sup>3</sup> of filter bed per day (Muir 1982). The depth of the filter bed varies from 0.7 to 1.0 m (Muir 1982). These filters must be cleaned periodically by backwashing and some means of disposal of the backwash must be provided.

## Biological filters

In biological filtration, the organic nitrogenous compounds in the water are converted aerobically into nitrate. Simply put, the process is a two-step conversion of ammonium nitrogen (NH<sub>4</sub><sup>+</sup>-N) to nitrate as shown by the kinetic reactions in Equations 1 and 2 (Wheaton 1977):

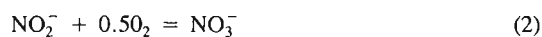
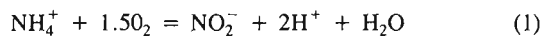

In Equation 1, ammonium nitrogen is utilized as an energy source by autotrophic bacteria of the genus *Nitrosomonas* and converted into the relatively toxic nitrite. In the second stage of the process (Equation 2), bacteria of the genus *Nitrobacter* convert the nitrite to the nontoxic nitrate. This process is called "nitrification" and is known by every fish culturist.

Although the nitrogen cycle begins with the conversion of organic nitrogen into ammonia, this stage is usually completed before the water reaches the biological filter. Ammonia occurs at very low concentrations in natural waters, or it may be present in fairly high concentrations in fish culture water that is to be recycled. Un-ionized ammonia (NH<sub>3</sub>) and nitrite (NO<sub>2</sub><sup>-</sup>) are toxic to fish and other aquatic animals at very low concentrations (Bell 1973; Boyd 1982; Wheaton 1977; Spotte 1970), while nitrate (NO<sub>3</sub><sup>-</sup>) appears to have very little, if any, toxicity even at concentrations as high as 400 mg/L (Boyd 1982; Wheaton 1977; Spotte 1970).

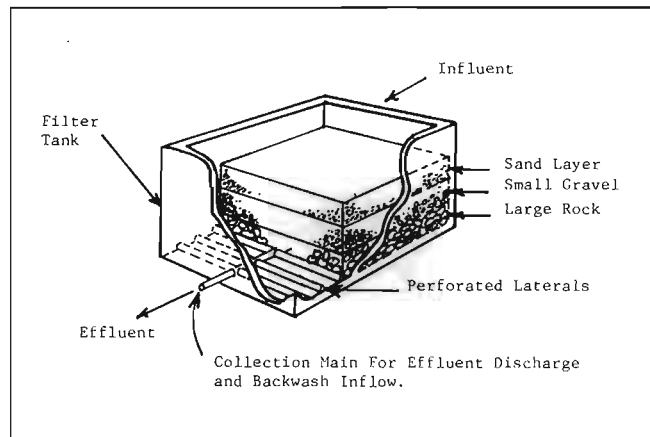

Figure 6—Rapid sand filter utilizing layers of different sized filter media (Wheaton 1977).

A discussion of biological filtration was included in solids removal, since the nitrification process just described begins with organic solids dissolved into solution. As previously mentioned, natural waters contain very little ammonia, the nitrification process being triggered by conversion of organic nitrogen to ammonia. However, water that has been previously used for fish culture may contain appreciable amounts of ammonia.

In biological filter design, the major operating parameters to be defined are filter configuration, flow rate and distribution, waste loading, surface area of the filter media, residence time, and such environmental variables as temperature, pH, oxygen concentration, and organic loading (Muir 1982).

Many types of filter media have been tried, the object being to increase the surface area available for bacterial growth. The rate of ammonia removal can be directly related to surface area in those systems where the flow through the media has been evenly distributed (Muir 1982). Some types of media include sand, gravel, stones, plastic media of various shapes and sizes, styrofoam shapes, wooden pallets, and plastic netting material. As water passes over the media, bacteria extract their nutrients, oxygen, and other life needs from the water.

There does not appear to be a general system or set of equations available to design biological filters. Most design efforts in the past have been based on the results of equations used to design submerged and trickling filters in sewage treatment plants. Many researchers in the past two decades have attempted to describe mathematically the design of biological filters for aquaculture use, with varying success. Their efforts are described at length by Wheaton (1977) and Muir (1982). Spotte (1970) recommended, as a rule of thumb, that a hydraulic loading rate of at least 42 L/(min · m<sup>2</sup>) of filter bed surface be maintained through the filter. Muir (1982) emphasized that for proper nitrification to take place within the filter, oxygen must be available throughout the filter bed. At least 1-2 mg/L of oxygen is required for nitrification to occur normally (Muir 1982).

A simple biological filter consists of a box filled with rocks (Fig. 7). Water enters the top, flows downward through the filter, and passes out through underdrains in the bottom of the box. This type of configuration is referred to as a downflow filter. Filters of the same basic configuration may be operated as upflow filters, where the water is forced upwards through the bottom of the box and flows out the top. Both of these filters generally perform the same, and since the rate of ammonia removal is related to surface area, the upflow and downflow regimes are equivalent (Muir 1982). One

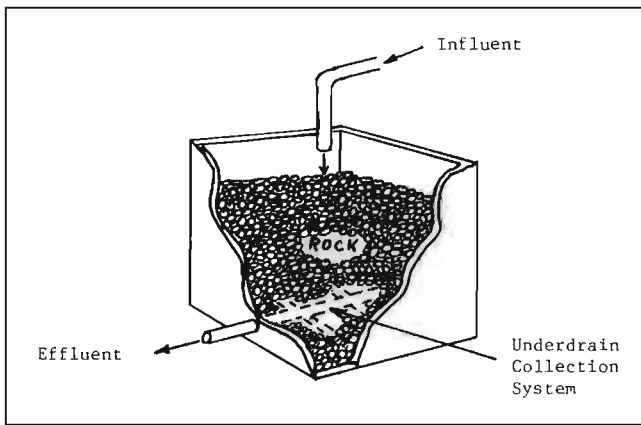

Figure 7—Typical downflow biological filter.

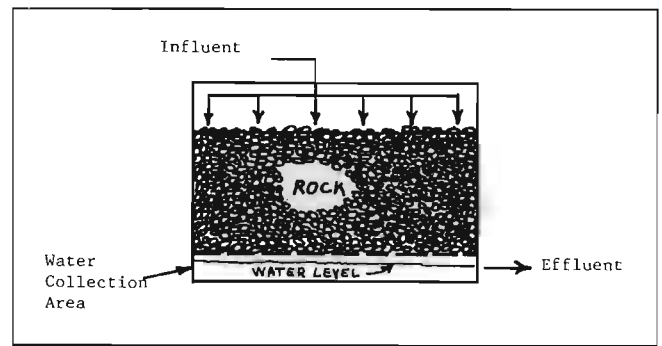

Figure 8—Trickling filter.

general advantage of upflow filters is that they seem to be less affected by solids clogging than downflow filters (Wheaton 1977).

Filters may also be classified as submerged or trickling filters. Submerged filters are those in which the filter media is kept completely under water. In trickling filters, the water level is maintained below the bottom of the filter (Fig. 8). An advantage of the trickling filter is that oxygen is supplied by natural air convection, and clogging by solids does not seem to be a problem (Wheaton 1977). In both types of filters, the particle size removed depends upon media particle size.

Another type of biological filter is the rotating biodisc or biodrum (Figs. 9 and 10). In these systems, fixed media are rotated through the water and nitrification proceeds as in other previously described systems, with nitrifying bacteria growing on the surfaces of the rotating media. Here again the emphasis is on designing the media with a maximum surface area. The discs or drums normally are rotated at about 2-6 revolutions/minute through the water medium, both aerating and allowing contact with the bacteria growing on the discs (Muir 1982). Suspended solids are normally separated and recycled through the tanks at the bottom of the discs (Muir 1982). Solid material sloughing off the discs are generally more easily settleable or removed by additional filtration. Fifty percent settling occurs within 10 minutes residence time, and 100% settling within 30 minutes (Muir 1982).

The disc surface area required is 0.5 m<sup>2</sup>/kg of fish for channel catfish (Muir 1982). A BOD and NH<sub>3</sub>-N removal of more than 95% occurs at a hydraulic loading of 0.06-0.1 m<sup>3</sup>/(m<sup>2</sup>·day) (Muir 1982). Surface area requirements and loading rates may vary between species. Biodiscs or biodrums may be operated singly or in multiple stages.

### Diatomaceous earth filters

Diatomaceous earth (DE) filters may be used to remove extremely fine particles (0.1-5 μ) (Muir 1982). In these filters a layer of graded skeletal remains of diatoms is held against a porous sleeve by vacuum or pressure, and particulate matter is removed as the water passes through. Because of the expense involved, these systems are only practical where water of extreme clarity is required. Typical loading rates are 43-130 m<sup>3</sup>/(m<sup>2</sup>·day) (Muir 1982).

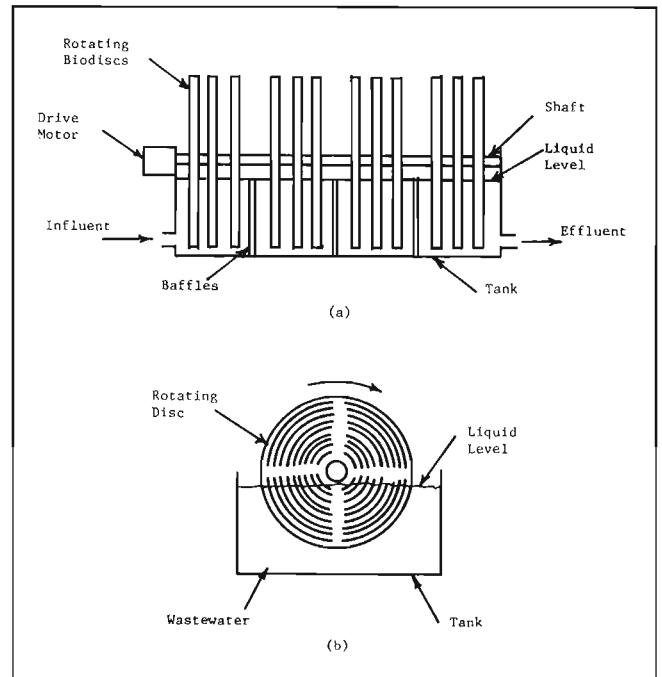

Figure 9—Rotating biodisc system (a) side view and (b) end view.

### Other systems

The filtering systems described in this paper are by no means the only options available to the fish culturist. Other methods exist for removing dissolved organic material, gases, ions, and molecules from solution. Some of these methods are activated carbon, foam fractionation, and ion exchange. Because of the complexity of these processes, discussion of each was considered out of the scope of this paper. For further discussion of these processes, the reader is referred to Spotte (1972), Wheaton (1977), and Muir (1982).

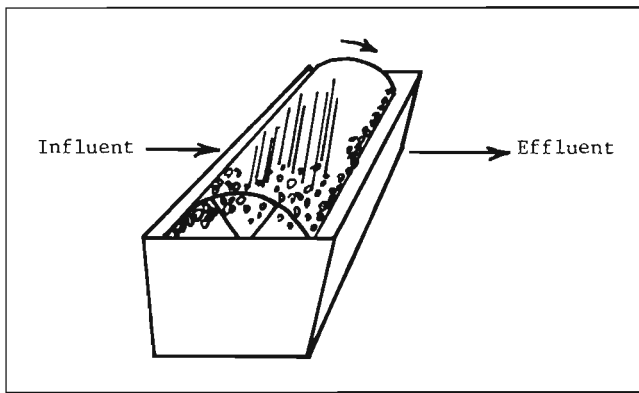

Figure 10—Single-stage biodrum system.

## CITATIONS

---

- BELL, M. C.  
1973. Fisheries handbook of engineering requirements and biological criteria. U.S. Army Corps of Engineers, Portland, OR.
- BOYD, C. E.  
1982. Water quality management for pond fish culture. Elsevier Sci. Publ. Co., New York, 708 p.
- LIAO, P. B., R. D. MAYO, and S. W. WILLIAMS.  
1972. A study for development of fish hatchery water treatment systems. U.S. Army Corps of Engineers, Walla Walla, WA.
- METCALF and EDDY, Inc.  
1972. Wastewater engineering: Collection, treatment, disposal. McGraw-Hill, New York, 782 p.
- MUIR, J. F.  
1982. Recirculated water systems in aquaculture. *In*: Muir, J. F., and R. J. Roberts (eds.), Recent advances in aquaculture. Croom Helm Publ., London, 453 p.
- PIPER, R. G., I. B. McELWAIN, L. E. ORMA, J. P. McCRAREN, L. G. FOWLER, and J. R. LEONARD.  
1982. Fish hatchery management. U.S. Dep. Int., Fish Wildl. Serv., Wash., D.C. 517 p.
- SAWYER, C. N., and P. L. McCARTY.  
1978. Chemistry for environmental engineering. McGraw-Hill, New York, 532 p.
- SPOTTE, S. H.  
1970. Fish and invertebrate culture. Wiley-Interscience, New York, 145 p.
- WHEATON, F. W.  
1977. Aquacultural engineering. Wiley-Interscience, New York, 708 p.