



NOAA Technical Report NMFS 16

Proceedings of the Ninth and Tenth U.S.-Japan Meetings on Aquaculture

Carl J. Sindermann (Editor)

*Under the U.S.-Japan Cooperative Program
in Natural Resources (UJNR)*

Panel Chairmen:

NINTH MEETING: AKIRA SUDA - Japan

WILLIAM N. SHAW - United States

TENTH MEETING: CONRAD MAHNKEN - United States

TAKESHI NOSE - Japan

November 1984

U.S. DEPARTMENT OF COMMERCE
National Oceanic and Atmospheric Administration
National Marine Fisheries Service

NOAA TECHNICAL REPORTS NMFS

The major responsibilities of the National Marine Fisheries Service (NMFS) are to monitor and assess the abundance and geographic distribution of fishery resources, to understand and predict fluctuations in the quantity and distribution of these resources, and to establish levels for optimum use of the resources. NMFS is also charged with the development and implementation of policies for managing national fishing grounds, development and enforcement of domestic fisheries regulations, surveillance of foreign fishing off United States coastal waters, and the development and enforcement of international fishery agreements and policies. NMFS also assists the fishing industry through marketing service and economic analysis programs, and mortgage insurance and vessel construction subsidies. It collects, analyzes, and publishes statistics on various phases of the industry.

The NOAA Technical Report NMFS series was established in 1983 to replace two subcategories of the Technical Reports series: "Special Scientific Report—Fisheries" and "Circular." The series contains the following types of reports: Scientific investigations that document long-term continuing programs of NMFS, intensive scientific reports on studies of restricted scope, papers on applied fishery problems, technical reports of general interest intended to aid conservation and management, reports that review in considerable detail and at a high technical level certain broad areas of research, and technical papers originating in economics studies and from management investigations.

Copies of NOAA Technical Report NMFS are available free in limited numbers to governmental agencies, both Federal and State. They are also available in exchange for other scientific and technical publications in the marine sciences. Individual copies may be obtained from: U.S. Department of Commerce, National Technical Information Service, 5285 Port Royal Road, Springfield, VA 22161.

NOAA Technical Report NMFS 16



Proceedings of the Ninth and Tenth U.S.-Japan Meetings on Aquaculture

Carl J. Sindermann (Editor)

*Under the U.S.-Japan Cooperative Program
in Natural Resources (UJNR)*

November 1984

U.S. DEPARTMENT OF COMMERCE

Malcolm Baldrige, Secretary

National Oceanic and Atmospheric Administration

John V. Byrne, Administrator

National Marine Fisheries Service

William G. Gordon, Assistant Administrator for Fisheries

PREFACE

The United States and Japanese counterpart panels on aquaculture were formed in 1969 under the United States-Japan Cooperative Program in Natural Resources (UJNR). The panels currently include specialists drawn from the federal departments most concerned with aquaculture. Charged with exploring and developing bilateral cooperation, the panels have focused their efforts on exchanging information related to aquaculture which could be of benefit to both countries.

The UJNR was started by a proposal made during the Third Cabinet-Level Meeting of the Joint United States-Japan Committee on Trade and Economic Affairs in January 1964. In addition to aquaculture, current subjects in the program are desalination of seawater, toxic microorganisms, air pollution, energy, forage crops, national park management, mycoplasmosis, wind and seismic effects, protein resources, forestry, and several joint panels and committees in marine resources research, development, and utilization.

Accomplishments include: Increased communications and cooperation among technical specialists; exchanges of information, data, and research findings; annual meetings of the panels, a policy coordinative body; administration staff meetings; exchanges of equipment, materials, and samples; several major technical conferences; and beneficial effects on international relations.

Akira Suda — Japan
William N. Shaw — United States

CONTENTS

NINTH MEETING

Papers presented by Japanese panel members:

KANAZAWA, A. Nutritional requirements and artificial diets of Kuruma shrimp, <i>Penaeus japonicus</i>	3
KURATA, H., K. SHIGUENO, and K. YATSUYANAGI. Kuruma shrimp culture in Japan	9
NOMA, T. Structure of a Kuruma shrimp culture pond	17

Papers presented by U.S. panel members:

LIGHTNER, D. V., R. M. REDMAN, D. A. DANALD, R. R. WILLIAMS, and L. A. PEREZ. Major diseases encountered in controlled environment culture of penaeid shrimp at Puerto Peñasco, Soñora, Mexico	25
MALECHA, S. Research and development in freshwater prawn, <i>Macrobrachium rosenbergii</i> , culture in the United States: Current status and biological constraints with emphasis on breeding and domestication	35
SHLESER, R. A., and L. F. FOLLETT. Research and development in maturation and production of penaeid shrimp in the Western Hemisphere	57
SPARKS, A. K. An invasive fungus disease of the Tanner crab and its aquacultural connotations	61

TENTH MEETING

Papers presented by Japanese panel members:

KANAZAWA, A., S. TESHIMA, M. SAKAMOTO, H. MATSUBARA, and T. ABE. An attempt to culture the noble scallop, <i>Mimachlamys nobilis</i> Reeve, using a microparticulate diet	71
NOGAMI, K., O. FUKUHARA, and S. UMEZAWA. Recent developments in shellfish culture in southern Japan	73
UKI, N. Abalone culture in Japan	83
WADA, K. Osmoregulation in marine bivalves	89

The National Marine Fisheries Service (NMFS) does not approve, recommend or endorse any proprietary product or proprietary material mentioned in this publication. No reference shall be made to NMFS, or to this publication furnished by NMFS, in any advertising or sales promotion which would indicate or imply that NMFS approves, recommends or endorses any proprietary product or proprietary material mentioned herein, or which has as its purpose an intent to cause directly or indirectly the advertised product to be used or purchased because of this NMFS publication.

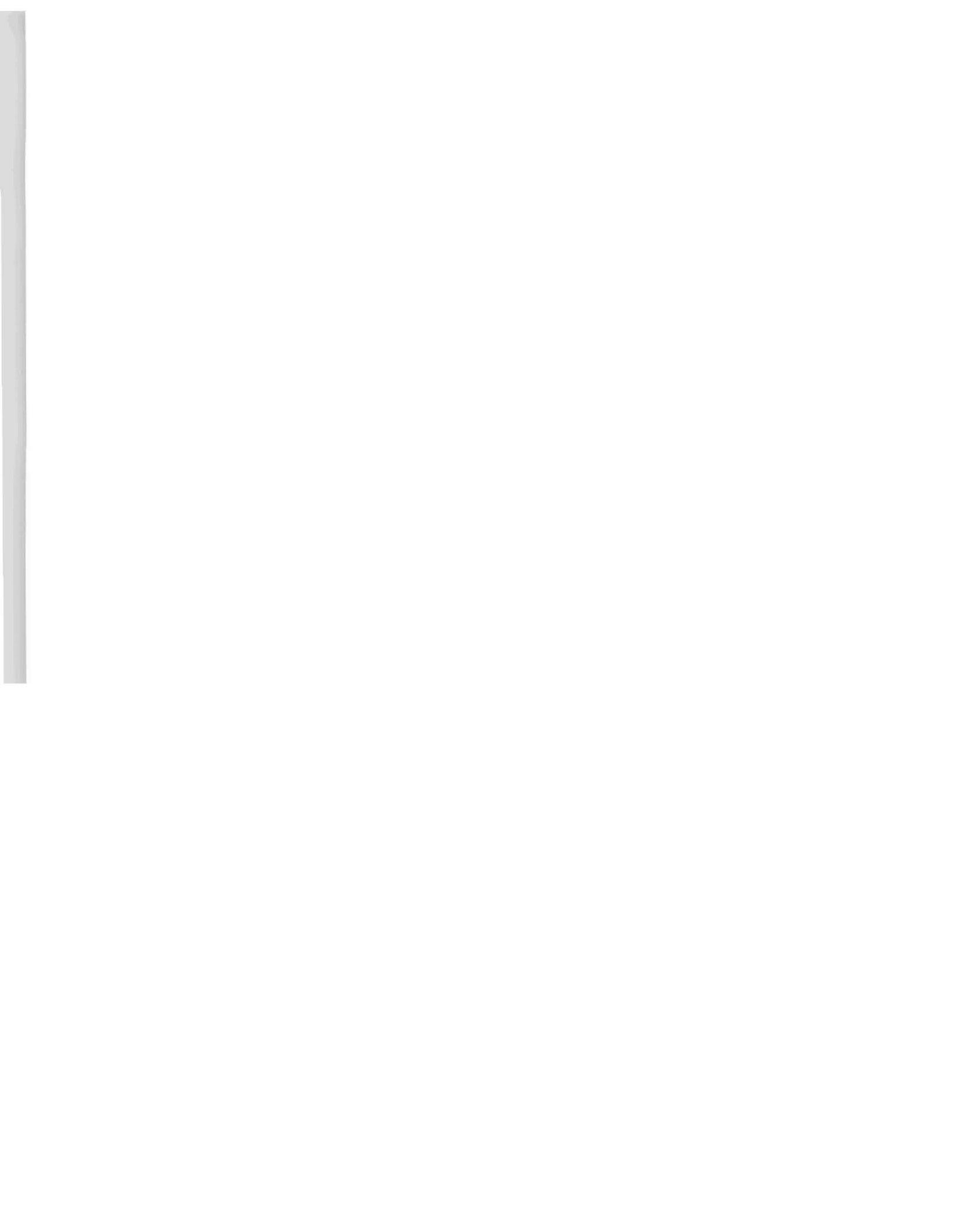

Statement of Ninth Joint Meeting of the UJNR Aquaculture Panel, Crustacean Culture, Kyoto, Japan, May 26-27, 1980

The Ninth Joint Meeting of the UJNR Aquaculture Panel was held on May 26-27, 1980, at the Kyoto International Conference Hall, in Kyoto, Japan. On the first day of the meeting, Dr. S. Sato announced a change of officers for the Japanese delegation. Dr. A. Suda is the new Chairman, and Dr. M. Fujiya the new Vice-Chairman. Dr. T. Nose is the new Secretary General. Mr. W. Shaw, the U.S. Chairman, announced that Dr. C. Mahnken will take over the chairmanship of UJNR for the American side at the conclusion of the 9th session; however, due to Mr. Shaw's accident, Dr. Mahnken chaired the session on the second day.

The business meeting was held on the second day. The morning session was chaired by Dr. Suda and afternoon session by Dr. Mahnken. Dr. Mahnken introduced Dr. Banerjee as the new Vice-Chairman of the U.S./UJNR panel.

1. Scientist Exchange

Panel concluded that the scientist exchange program sponsored by UJNR has been an effective means of advancing aquaculture science and the exchange of information between the two countries. An extended study visit by one U.S. scientist (Mr. McCormick) is in progress and the visit of another U.S. scientist (Dr. Murchelano) may occur in September 1980 or March 1981.

Dr. Shleser will visit Japanese aquaculture industries in the near future. Four U.S. scientists visited Japan to participate in the 9th UJNR Conference (Drs. Shleser, Clark, Lightner, and Malecha). It was suggested by the Japanese that a detail travel plan and coordination be affected previous to arrival of exchange scientists. Dr. Arai will be the next Japanese scientist to visit the U.S. during 1980. He will conduct cooperative research on fish nutrition with Dr. Mahnken at the Northwest and Alaska Fisheries Center (NWAFC), National Marine Fisheries Service, at Seattle, Washington.

It was agreed to exchange information relative to the location and activities of aquaculture scientists in both countries. It was also agreed that a continuous exchange of information on relevant issues be affected by the two chairmen.

2. Literature Exchange

The U.S. and Japan will continue literature exchange as done in the past. The U.S. chairman suggested that aquaculture literature search can be obtained from NWAFC computer facilities.

One translation (Eel culture) was given to the Japanese panel this year. The U.S. also elected to send the national aquaculture plan to the Japanese chairman. The Japanese requested literature on the culture of seaweed.

3. Cooperative Studies

An up-date of ongoing programs was presented. These included:

- a) Mass mortality of oysters.
- b) Disease resistance of U.S. oysters in Japan (project needs re-evaluation).
- c) Register of marine pathology (under consideration).
- d) Cooperative studies on abalone (under consideration).

4. Second Five-Year Plans

The Japanese panel proposed two projects.

- a) Large scale propagation of salmon.
- b) Marine ranching.

The U.S. panel proposed four projects.

- a) Salmon farming with emphasis on evaluation of ocean stocking, seeding technique, carrying capacity, and smolt physiology.
- b) Aquaculture engineering with emphasis on structures and new automated husbandry techniques.
- c) Reproductive physiology, genetics, breeding of aquaculture species.
- d) Environmental quality standards in aquaculture systems with emphasis on control of metabolic by-products (self pollution).

5. Next Joint Meeting

The theme of the meeting will be "Molluscan Aquaculture," the site, the University of Delaware, and the date, September 1981.

It was agreed that UJNR will jointly sponsor a crustacean and molluscan nutrition symposium with the World Mariculture Society and the University of Delaware. The symposium will be held close to the scheduled time of the UJNR meeting. Japanese participants will include Dr. Koji Wada.

6. Field Trip

U.S. chairman thanked Dr. Matsusato for extensive activities on behalf of the panel.

7. Publication

An editorial policy will be developed at a later date by the U.S. panel and will be forwarded to the Japanese panel for review.

Akira Suda — Japan
William N. Shaw — United States

Nutritional Requirements and Artificial Diets of Kuruma Shrimp, *Penaeus japonicus*

AKIO KANAZAWA¹

INTRODUCTION

Since Hudinaga (1942) succeeded in the artificial hatching and subsequent culture of larvae of Kuruma shrimp, *Penaeus japonicus*, techniques in these fields have developed remarkably. Now, in Japan, Kuruma shrimp have been produced in commercial shrimp farms under artificially controlled conditions from hatching to market size. However, problems still remain to be solved concerning disease and the quality and cost of diets. Nearly half of the reasons for shrimp disease seem to be directly or indirectly attributable to nutritionally deficient diets.

Like other animals, shrimp require proteins, lipids, carbohydrates, minerals, and vitamins. Lack of even one nutrient results in deficiency disease, poor growth, and mortality during rearing. In this presentation, I will discuss my investigation on the nutritional requirements for proteins, lipids, minerals, carbohydrates, and vitamins in Kuruma shrimp.

PROTEINS AND ESSENTIAL AMINO ACIDS

The dietary protein requirement of Kuruma shrimp was estimated to be 52% when casein was used as a protein source (Deshimaru and Yone 1978) (Fig. 1). This value was higher than the requirement for proteins in the eel (45%) and the carp (39%).

Next, I tried to culture Kuruma shrimp using a diet containing a mixture of amino acids, instead of casein, to determine the essential amino acid requirements. However, the above amino acid diet did not support the growth of Kuruma shrimp. Therefore, the essential amino acids were evaluated by tracer experiments in which the incorporation of [³H] acetate into each amino acid was examined after injection (Kanazawa and Teshima 1981) (Table 1). On the basis of the results of these tracer experiments, arginine, methionine, valine, threonine, isoleucine, leucine, lysine, histidine, phenylalanine, and tryptophan were found to be essential for Kuruma shrimp (Table 2).

LIPIDS

Feeding trials showed that lipids were important nutrients for Kuruma shrimp, not only as an energy source, but also as a source of indispensable substances such as essential fatty acids and sterols.

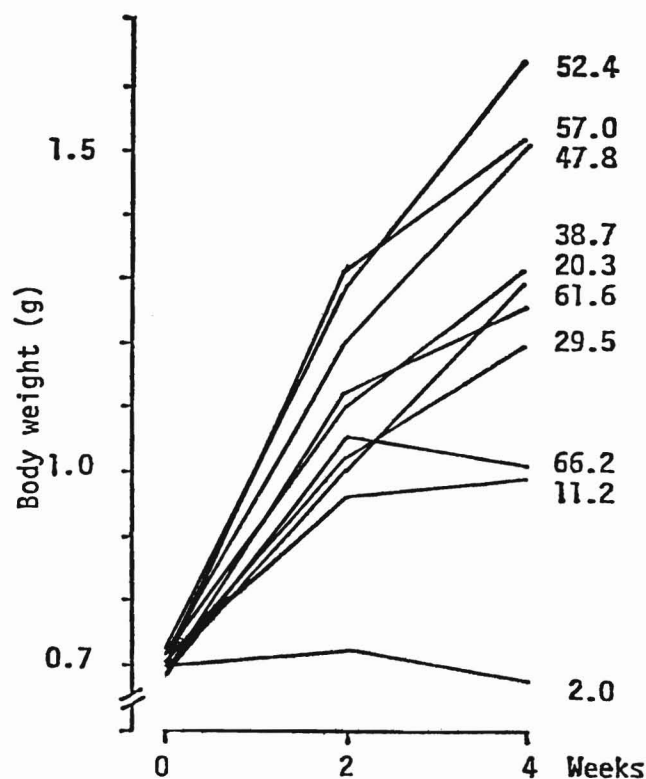

Figure 1.—Growth curves of Kuruma shrimp fed on diets containing different protein levels (percent).

Table 1.—Incorporation of radioactivity into the individual amino acids of protein fraction in shrimps 6 d after injection of [³H] acetate.

Amino acids	Specific activity (cpm/ μ mole)	Amino acids	Specific activity (cpm/ μ mole)
Aspartic acid	203	Valine	0.1
Serine	102	Methionine	2.5
Glutamic acid	196	Isoleucine	0.7
Proline	138	Leucine	0.1
Glycine	132	Phenylalanine	0.1
Alanine	187	Lysine	0.2
Cystine	159	Histidine	0.7
Tyrosine	1.2	Arginine	1.2
Threonine	1.9	Tryptophan	0.4

¹Faculty of Fisheries, University of Kagoshima, 4-50-20 Shimoarata, Kagoshima 890, Japan.

Table 2.—Essential amino acid requirements of Kuruma shrimp. + = essential; - = nonessential.

Amino acid	<i>Penaeus japonicus</i>	Amino acid	<i>Penaeus japonicus</i>
Aspartic acid	-	Methionine	+
Cystine	-	Valine	+
Alanine	-	Threonine	+
Glutamic acid	-	Isoleucine	+
Serine	-	Leucine	+
Glycine	-	Lysine	+
Proline	-	Histidine	+
Tyrosine	-	Phenylalanine	+
Arginine	+	Tryptophan	+

Requirements for Sterols

Although animals generally synthesize cholesterol from lower units, such as acetate and mevalonate, Kuruma shrimp and other crustaceans lack this sterol-synthesizing ability (Zandee 1962, 1964, 1966, 1967; Van den Oord 1964; Gosselin 1965; Whitney 1969, 1970; Teshima and Kanazawa 1971; Walton and Pennock 1972; O'Rourke and Monroe 1976; Teshima et al. 1976) (Table 3). However, cholesterol was shown to be the precursor of steroid hormones (Kanazawa and Teshima 1971) and molting hormones (Spaziani and Kater 1973; Gagosian et al. 1974) in crustaceans. These results indicated that cholesterol is an essential substance for normal growth in crustaceans. My feeding experiments revealed that the dietary cholesterol requirement in Kuruma shrimp was about 0.5% (Kanazawa et al. 1971) (Fig. 2).

Table 3.—Biosynthesis of sterols in Crustacea.

Species	Incorporation	References
<i>Astacus astacus</i>	—	Zandee (1962, 1964, 1966)
<i>Cancer pagrus</i>	—	Van den Oord (1964)
<i>Homarus gammarus</i>	—	Zandee (1964, 1967)
<i>Astacus fluviatilis</i>	—	Gosselin (1965)
<i>Rhithropanopus harrissii</i>	—	Whitney (1969)
<i>Libinia emerginata</i>	—	
<i>Callinectes sapidus</i>	—	Whitney (1970)
<i>Balanus nubilus</i>	—	
<i>Artemia salina</i>	—	Teshima and Kanazawa (1971)
<i>Penaeus japonicus</i>	—	
<i>Panulirus japonica</i>	—	
<i>Portunus trituberculatus</i>	—	
<i>Carcinus maenas</i>	—	Walton and Pennock (1972)
<i>Eupagurus bernhardus</i>	—	
<i>Armadillidium unlgare</i>	—	O'Rourke and Monroe (1976)
<i>Cirolana halfordi</i>	—	
<i>Ligia occidentalis</i>	—	
<i>Helice tridens tridens</i>	—	Teshima et al. (1976)
<i>Searma dehaani</i>	—	

Essential Fatty Acids

In Kuruma shrimp, linolenic acid (18:3 ω 3) was more effective as an essential fatty acid than linoleic acid (18:2 ω 6). However, eicosapentaenoic acid (20:5 ω 3) and docosahexaenoic acid (22:6 ω 3) exerted a higher essential fatty acid activity than 18:3 ω 3 for the shrimp (Kanazawa et al. 1977, 1978; Kanazawa, Teshima, Tokiwa, Kayama, and Hirata 1979) (Fig. 3). The dietary requirements for either 20:5 ω 3 or 22:6 ω 3 in Kuruma shrimp were estimated to be about 1% (Kanazawa, Teshima, and Endo 1979) (Fig. 4). Therefore, poor growth of Kuruma shrimp on diets

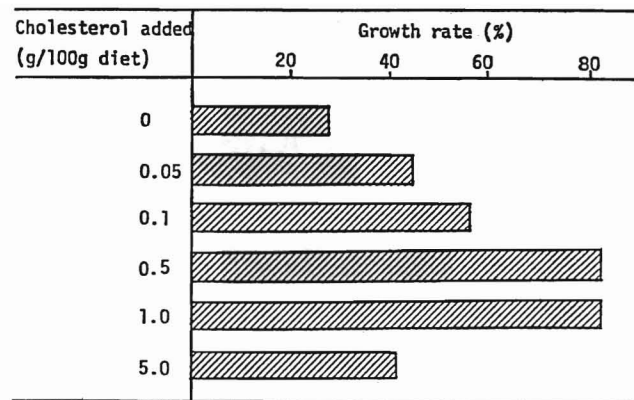

Figure 2.—Effect of cholesterol levels on growth of Kuruma shrimp.

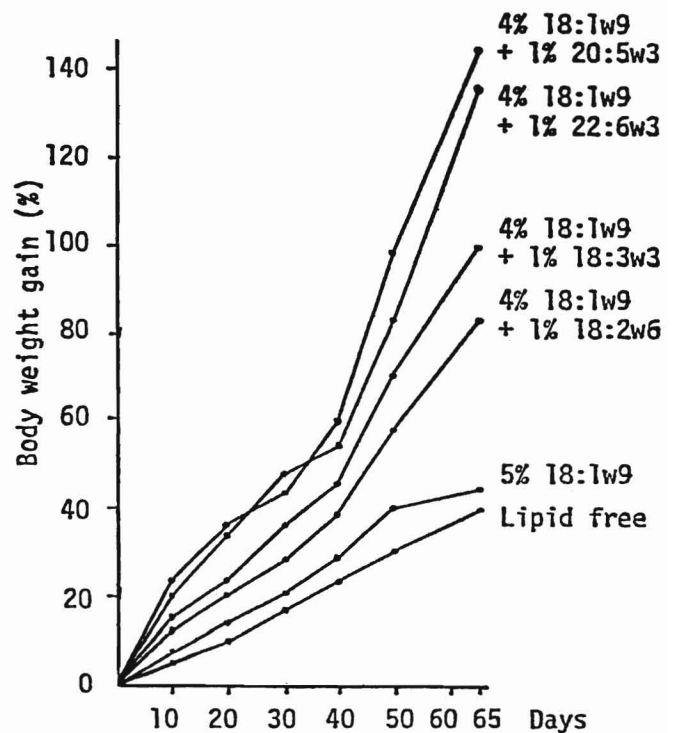

Figure 3.—Growth of Kuruma shrimp fed diets containing several fatty acids.

containing vegetable oils such as soybean oil and corn oil, is probably attributable to the lack of highly polyunsaturated fatty acids. Fish oil, such as cod liver oil rich in ω 3-polyunsaturated fatty acids, produced a high growth rate for Kuruma shrimp.

Growth-Promoting Factor in Short-Necked Clam Oil

Feeding trials showed that short-necked clam oil produced the highest growth rate for Kuruma shrimp among the several lipid sources examined. These results suggested that short-necked clam oil probably contained certain growth-promoting factors besides essential fatty acids. The search for these factors demonstrated that the growth-promoting effect of short-necked clam oil was mainly due to lecithin and kephalin (Kanazawa, Teshima, Tokiwa, Endo, and Abdel Razek 1979) (Fig. 5).

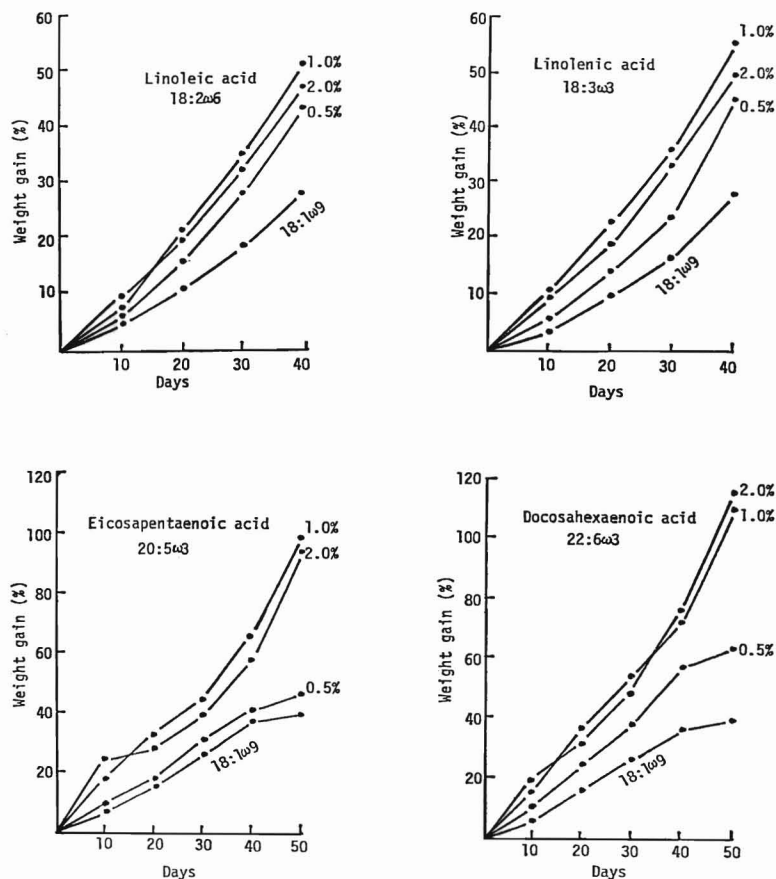

Figure 4.—Dietary requirement of Kuruma shrimp for linoleic, linolenic, eicosapentaenoic, and docosahexaenoic acids.

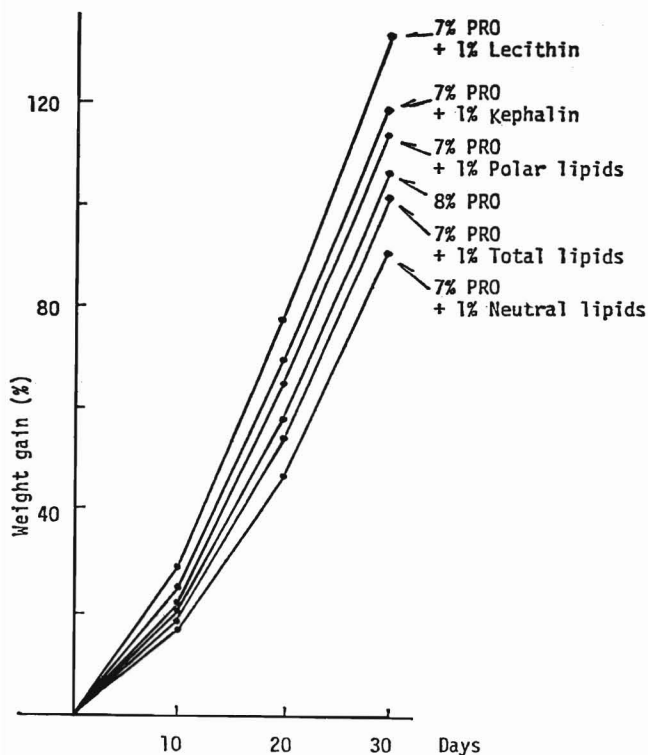

Figure 5.—Effect of short-necked clam lipids on growth of Kuruma shrimp (PRO = pollack liver oil).

MINERALS

Although the shrimp absorb some minerals from seawater, mineral supplementation is necessary for optimum growth. I assume that Kuruma shrimp require a dietary source of minerals because of the considerable loss of calcium and other minerals contained in the exoskeletons during molting. Mineral requirements of Kuruma shrimp were estimated as follows (mg/g of diet): Ca, 10; P, 10; K, 9; Mg, 3; Cu, 0.06 (Fig. 6). The addition of Fe and Mn to the diet resulted in a decrease in growth rate (Kanazawa and Teshima in press).

CARBOHYDRATES

Interestingly, disaccharides and polysaccharides were superior to monosaccharides, such as glucose, as a carbohydrate source for Kuruma shrimp. Diets containing disaccharides, such as maltose and sucrose, produced high growth and survival rates (Abdel-Rahman et al. 1979) (Fig. 7). The addition of 0.8% glucosamine improved the growth of Kuruma shrimp, whereas that of chitin resulted in a decrease in growth rate.

VITAMINS

The requirements for vitamin C, choline, and inositol in Kuruma shrimp were determined to be 1.0, 0.06, and 0.2% of the diet (Figs. 8, 9, 10), respectively. Diets lacking in vitamin C resulted in poor growth and high mortality (Kanazawa et al. 1976;

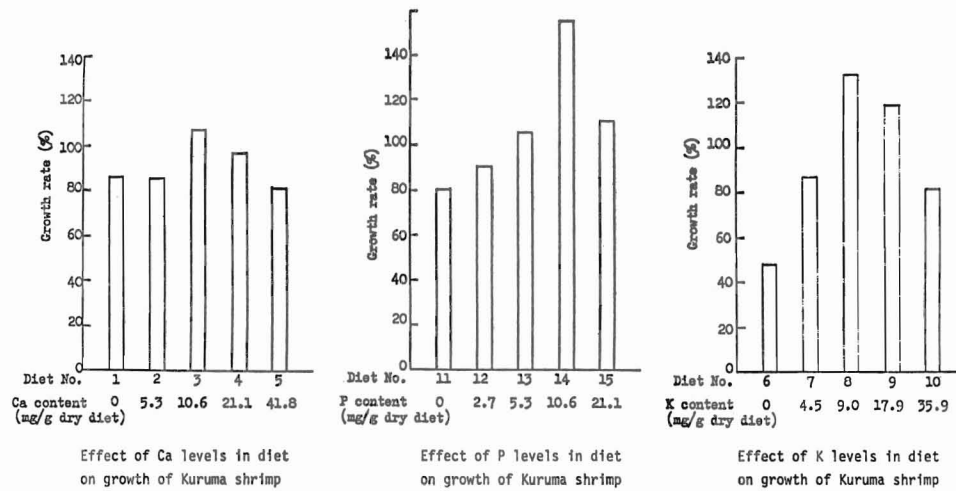

Figure 6.—Requirements for minerals in Kuruma shrimp.

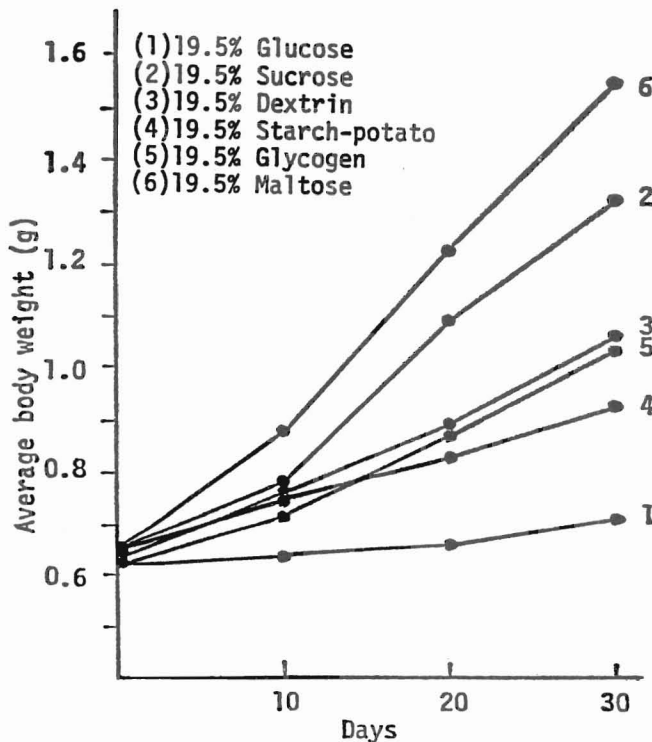

Figure 7.—Effect of dietary carbohydrates on growth of Kuruma shrimp.

Guary et al. 1976). Dietary requirements of Kuruma shrimp for thiamine and pyridoxine were found to be approximately 6-12 and 12 mg%, respectively (Deshimaru and Kuroki 1979).

COMMERCIAL DIETS FOR KURUMA SHRIMP

On the basis of my results on the nutritional requirements of Kuruma shrimp, several types of diet for Kuruma shrimp were commercially produced in Japan. Some diets resulted in a higher growth rate than live feed. The annual production of commercial diets for Kuruma shrimp is about 1,500 tons.

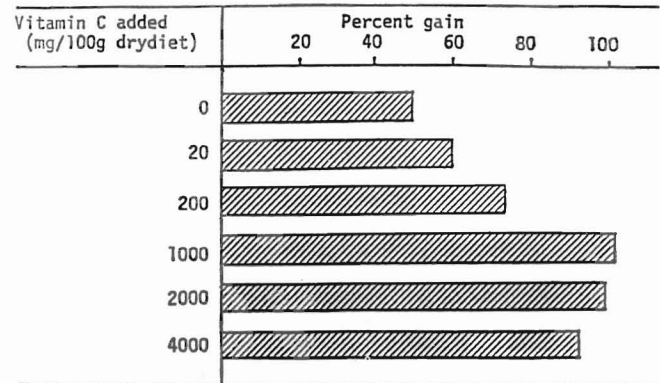

Figure 8.—Effect of vitamin C levels on growth of Kuruma shrimp.

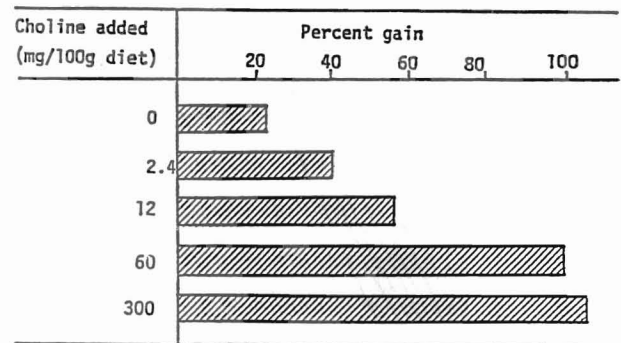

Figure 9.—Effect of choline levels on growth of Kuruma shrimp.

MICROENCAPSULATED DIETS

Live feed is used in the culture of larvae after hatching. My laboratory has attempted to make an artificial diet for larval Kuruma shrimp. Recently, the staff has succeeded in culturing Kuruma shrimp larvae from zoea stage to postlarvae by feeding only the microencapsulated diet (Jones et al. 1979).

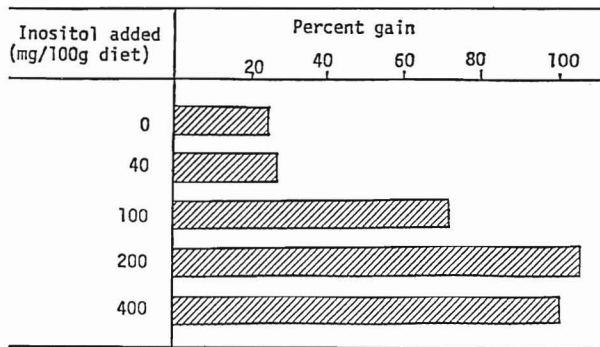

Figure 10.—Effect of inositol levels on growth of Kuruma shrimp.

CONCLUSION

My nutritional studies have made a contribution to the development of formula diets which are coming into the market. Previously, live feed, such as the short-necked clam and the mussel, was widely used for the culture of Kuruma shrimp and was an excellent diet. However, such live feeds are too expensive for use in shrimp culture and the supply is unstable. If one uses materials lacking in some nutrients, careful attention should be paid to adjust every nutrient, such as proteins, lipids, minerals, carbohydrates, and vitamins, to adequate levels on the basis of data on the nutritional requirements of Kuruma shrimp.

It is necessary to devise a diet which accelerates ovary maturation in Kuruma shrimp. If this problem can be solved, the culture of Kuruma shrimp can be performed completely under artificial conditions.

LITERATURE CITED

- ABDEL-RAHMAN, S. H., A. KANAZAWA, and S. TESHIMA.
1979. Effects of dietary carbohydrate on the growth and the levels of the hepatopancreatic glycogen and serum glucose of prawn. *Bull. Jpn. Soc. Sci. Fish.* 45:1491-1494.
- DESHIMARU, O., and K. KUROKI.
1979. Requirement of prawn for dietary thiamine, pyridoxine, and choline chloride. *Bull. Jpn. Soc. Sci. Fish.* 45:363-367.
- DESHIMARU, O., and Y. YONE.
1978. Optimum level of dietary protein for prawn. *Bull. Jpn. Soc. Sci. Fish.* 44:1395-1397.
- GAGOSIAN, R. B., R. A. BOURBONNIERE, W. B. SMITH, E. F. COUCH, C. BLANTON, and W. NOVAK.
1974. Lobster molting hormones: Isolation and biosynthesis of ecdysterone. *Experientia* 30:723-724.
- GOSELIN, L.
1965. L'utilisation de l'acide mévalonique-2-¹⁴C, in vivo, dans l'hépatopancreas de *Astacus fluviatilis*. *Arch. Int. Physiol. Biochim.* 73:543-544.
- GUARY, M., A. KANAZAWA, N. TANAKA, and H. J. CECCALDI.
1976. Nutritional requirements of prawn - VI. Requirement for ascorbic acid. *Mem. Fac. Fish., Kagoshima Univ.* 25:53-57.
- HUDINAGA, M.
1942. Reproduction, development and rearing of *Penaeus japonicus* Bate. *Jpn. J. Sci.* 10:305-393.

- JONES, D. A., A. KANAZAWA, and S. ABDEL RAHMAN.
1979. Studies on the presentation of artificial diets for rearing the larvae of *Penaeus japonicus* Bate. *Aquaculture* 17:33-43.
- KANAZAWA, A., N. TANAKA, S. TESHIMA, and K. KASHIWADA.
1971. Nutritional requirements of prawn—II. Requirement for sterols. *Bull. Jpn. Soc. Sci. Fish.* 37:211-215.
- KANAZAWA, A., and S. TESHIMA.
1971. *In vivo* conversion of cholesterol to steroid hormones in the spiny lobster, *Panulirus japonica*. *Bull. Jpn. Soc. Sci. Fish.* 37:891-898.
1981. Essential amino acids of the prawn. *Bull. Jpn. Soc. Sci. Fish.* 47:1375-1377.
- In press. Requirements for minerals in prawn. *Mem. Fac. Fish. Kagoshima Univ.*
- KANAZAWA, A., S. TESHIMA, and M. ENDO.
1979. Requirements of prawn, *Penaeus japonicus*, for essential fatty acids. *Mem. Fac. Fish., Kagoshima Univ.* 28:27-33.
- KANAZAWA, A., S. TESHIMA, M. ENDO, and M. KAYAMA.
1978. Effects of eicosapentaenoic acid on growth and fatty acid composition of the prawn, *Penaeus japonicus*. *Mem. Fac. Fish., Kagoshima Univ.* 27:35-40.
- KANAZAWA, A., S. TESHIMA, and N. TANAKA.
1976. Nutritional requirements of prawn - V. Requirements for choline and inositol. *Mem. Fac. Fish., Kagoshima Univ.* 25:47-51.
- KANAZAWA, A., S. TESHIMA, S. TOKIWA, M. ENDO, and F. A. ABDEL RAZEK.
1979. Effects of short-necked clam phospholipids on the growth of prawn. *Bull. Jpn. Soc. Sci. Fish.* 45:961-965.
- KANAZAWA, A., S. TESHIMA, S. TOKIWA, M. KAYAMA, and M. HIRATA.
1979. Essential fatty acids in the diet of prawn—II Effect of docosahexaenoic acid on growth. *Bull. Jpn. Soc. Sci. Fish.* 45:1151-1153.
- KANAZAWA, A., S. TOKIWA, M. KAYAMA, and M. HIRATA.
1977. Essential fatty acids in the diet of prawn—I Effects of linoleic and linolenic acids on growth. *Bull. Jpn. Soc. Sci. Fish.* 43:1111-1114.
- O'ROUKE, L., and R. E. MONROE.
1976. Utilization of radiolabelled acetate by three isopods in lipid synthesis. *Comp. Biochem. Physiol.* 55B:553-557.
- SPAZIANI, E., and S. B. KATER.
1973. Uptake and turnover of cholesterol-¹⁴C in Y-organs of the crab *Hemigrapsus* as a function of the molt cycle. *Gen. Comp. Endocrinol.* 20:534-549.
- TESHIMA, S., and A. KANAZAWA.
1971. Biosynthesis of sterols in the lobster, *Panulirus japonica*, the prawn, *Penaeus japonicus*, and the crab, *Portunus triuber culatus*. *Comp. Biochem. Physiol.* 38B:597-602.
- TESHIMA, S., A. KANAZAWA, and H. OKAMOTO.
1976. Sterol biosynthesis from acetate and the fate of dietary cholesterol and desmosterol in crabs. *Bull. Jpn. Soc. Sci. Fish.* 42:1273-1280.
- VAN den OORD, A.
1964. The absence of cholesterol synthesis in crab, *Cancer pagurus* L. *Comp. Biochem. Physiol.* 13:461-467.
- WALTON, M. J., and J. F. PENNOCK.
1972. Some studies on the biosynthesis of ubiquinone, isoprenoid alcohols, squalene and sterols by marine invertebrates. *Biochem. J.* 127:471-479.
- WHITNEY, J. O.
1969. Absence of sterol synthesis in larvae of the mud crab *Rhithropanopeus harrissii* and of the spider crab *Libinia emarginata*. *Mar. Biol. (Berl.)* 3:134-135.
1970. Absence of sterol biosynthesis in the blue crab *Callinectes sapidus* Rathbun and in the barnacle *Balanus nubilus* Darwin. *J. Exp. Mar. Biol. Ecol.* 4:229-237.
- ZANDEE, D. I.
1962. Lipid metabolism in *Astacus astacus* L. *Nature (Lond.)* 195:814-815.
1964. Absence of sterol synthesis in some Arthropods. *Nature (Lond.)* 202:1335-1336.
1966. Metabolism in the crayfish *Astacus astacus* (L.). III.—Absence of cholesterol synthesis. *Arch. Int. Physiol. Biochim.* 74:435-441.
1967. Absence of cholesterol synthesis as contrasted with the presence of fatty acid synthesis in some Arthropods. *Comp. Biochem. Physiol.* 20:811-822.



Kuruma Shrimp Culture in Japan

HIROSHI KURATA,¹ KUNIHICO SHIGUENO,² and
KENRO YATSUYANAGI³

INTRODUCTION

Live Kuruma shrimp is one of the most esteemed seafood delicacies in Japan. Its maximum price may exceed ¥10,000 (about US\$45)/kg at the wholesale market in large cities. Japan's fishery and transport industries exercise special care in handling this product to assure its freshness because of its prime importance in determining its market price. Most Kuruma shrimp are kept alive throughout the entire process of catching or harvesting, and packing and shipping to urban consumption centers.

Kuruma shrimp culture in Japan began in the early 1960's and has developed to a ¥9 billion business within 20 yr. Culture techniques practiced today in Japan may be divided into two major types according to the kind of facilities used for growing. One is an extensive type using tidal ponds of 0.5-5.0 ha in area pioneered by the late M. Hujinaga; the other is an intensive type using concrete tanks with a dual bottom system developed by K. Shigueno. There are considerable variations in detail within each type.

Culture techniques of Kuruma shrimp have been reported in detail, along with experimental data, by Shigueno (1975) and Hujinaga et al. (1977). Commercial aspects of Kuruma shrimp culture have been analyzed economically by Hirasawa and Walford (1979). This report briefly summarizes the present status and problems of the Kuruma shrimp culture industry in Japan from a technical and, to some extent, economic point of view.

CONSUMPTION AND PRODUCTION OF SHRIMP IN JAPAN

The Japanese nominal annual consumption of all kinds of shrimp, as defined by domestic production plus imports, has climbed steadily during the last 20 yr from about 0.6 kg per capita in 1960 to 3.3 kg per capita in 1979 on a fresh head-on basis. Over the same period, domestic production has remained relatively stable at 60-70 thousand t (metric tons) a year. The increased consumption is associated with increased imports of penaeid shrimp from Asia and South America. Figure 1 shows that in Japan shrimp of all kinds combined have supported a ¥ 300-400 billion business in recent years.

Japan's demand for shrimp as a whole has leveled off recently. However, the situation is quite different for live Kuruma shrimp. Hirasawa and Walford (1979) estimated, based on income elasticity analysis, that a 10% increase in per capita income will enhance the demand for live Kuruma shrimp by 22%.

Figure 2 shows that the domestic annual catch of wild Kuruma shrimp by fisheries in Japan has, for the most part, fluctuated between 2,000 and 3,000 t over the past 30 yr. The drastic fall in the late 1960's recovered in the early 1970's owing to concentrated efforts in releasing artificial fry in coastal nursery grounds. Culture production, on the other hand, has followed a more or less steady increase since its beginning. Figure 2 also illustrates that the area of production is concentrated in the southern part of Japan. The major limiting factors in the abundance and distribu-

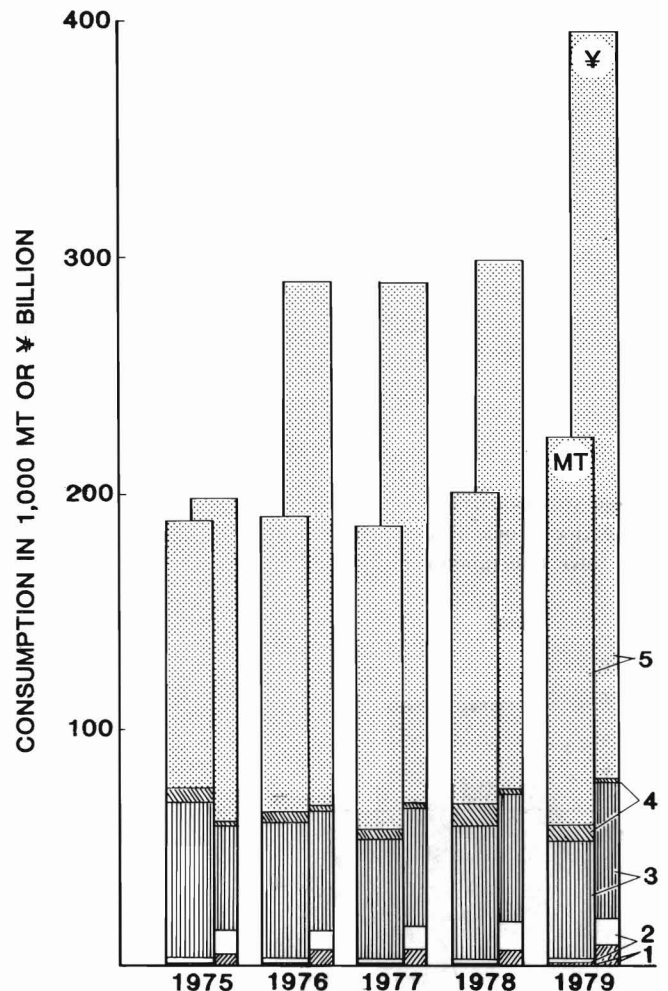

Figure 1.—Japan's nominal annual consumption of all kinds of shrimp. Amount of import may be doubled when converted into original fresh head-on weight. 1-4, domestic production in head-on weight; 1, cultured Kuruma shrimp; 2, wild Kuruma shrimp; 3, other marine shrimps; 4, freshwater shrimps; 5, imported shrimps, heads-off, frozen, salted, or dried. Data from the Fisheries Trade Statistics and the Annual Report of Catch Statistics on Fisheries and Aquaculture, Japanese Government.

¹Nansei Regional Fisheries Research Laboratory, Ohno-cho, Hiroshima 739-40, Japan.

²Kagoshima Prefecture Fisheries Research Station, Kinko-cho, Kagoshima 892, Japan.

³Yamaguchi Prefecture Fisheries Seed Production Center, Aio-cho, Yamaguchi 754-11, Japan.

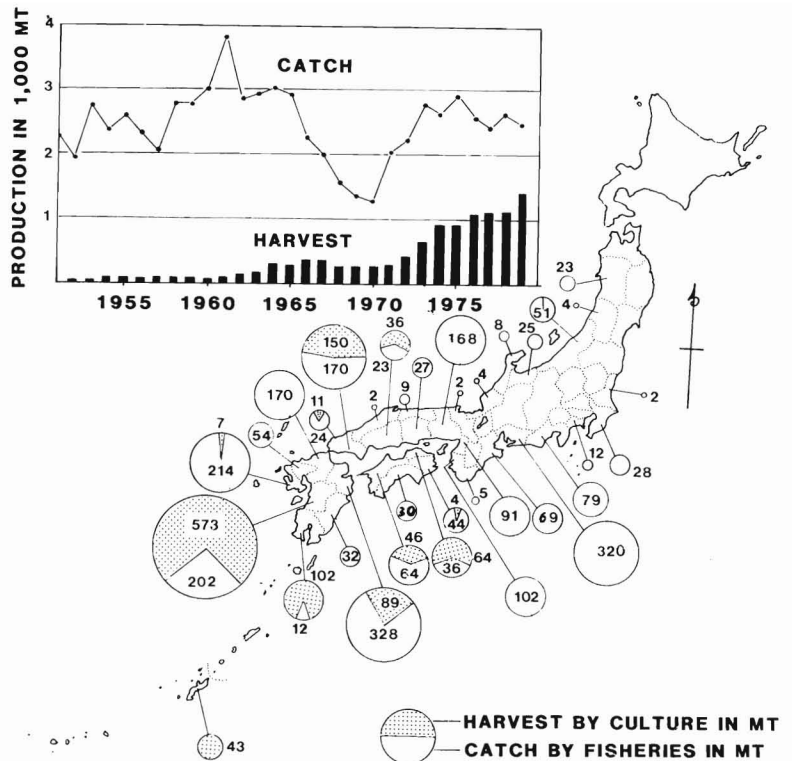

Figure 2.—Domestic catch and harvest of Kuruma shrimp in Japan, showing annual trend (upper) and production by prefecture in 1977 (lower). Data from the Annual Report of Catch Statistics on Fisheries and Aquaculture, Japanese Government.

tion of the wild population are the temperature of coastal waters and the lack of large expanses of intertidal flats in the immediate inshore areas. The centers of culture production are shifted further south and include Okinawa where there are no wild populations.

The data presented in Figure 3 show that wild Kuruma shrimp are fished for the most part from May to October, with the busiest season from June to September. Cultured Kuruma shrimp are harvested during the rest of the year when the market price is relatively high. The main localities of Kuruma shrimp culture are in the Seto Inland Sea, Amakusa, and Kagoshima. They differ in the period of peak shipment depending on the water temperature in winter, thus minimizing competition in the common market.

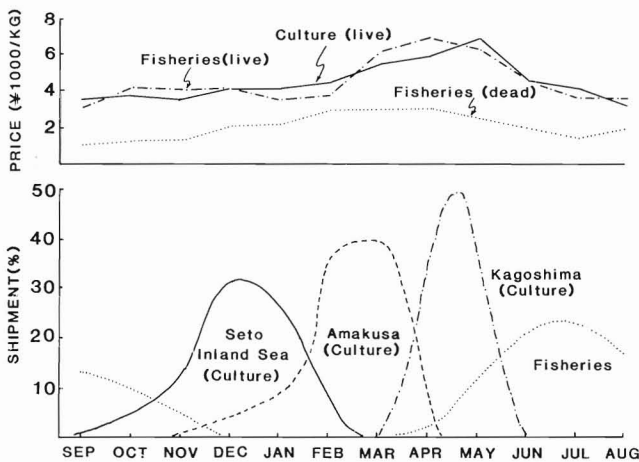

Figure 3.—Monthly variation of the wholesale price in Tokyo market in 1974 (upper) and of shipment by localities (lower). (Hirasawa and Walford 1979.)

CULTURE TECHNIQUES

Fry Production

Spawners.—All the spawners for fry production are separated from ordinary commercial catches. Artificial spawner production is not yet practiced in Japan on a commercial scale. Wild spawners are available as early as mid-March in restricted oceanic grounds and as late as early October in coastal grounds.

Spawners are introduced directly into the breeding tank upon arrival in the required numbers. The percentage of accepted spawners that successfully spawn in the tank range from 20 to 50% depending on their activity and size. Usually they are held in the tank for 2 d and are removed on the third day before rapid growth of diatoms begins.

Breeding tank.—A simple rectangular concrete tank, 100-250 m³ in volume, is used in commercial fry culture. As long as a sufficient number of spawners is available, a large tank is preferred. Figure 4 shows the layout of a common rearing tank. It is usually covered by transparent materials to maximize the use of solar energy. The agitation of rearing water is effected by aeration with blowers through air diffuser stones. A rotary blade may also be installed slightly above the tank bottom to ensure a homogeneous distribution of larvae, feed, and organic wastes. The tank water is heated early in the breeding season when the water is not warm enough for larval development. The optimum temperature range is 26°-28°C.

Coastal seawater is filtered through a sand layer before it is introduced to the rearing tank. Shrimp larvae require clean water for survival. The quality of the rearing water is controlled by the daily addition of fresh seawater during the early phase of rearing. For this purpose the tank is filled with seawater to less than one-half of its actual depth when spawners are introduced. By the time the

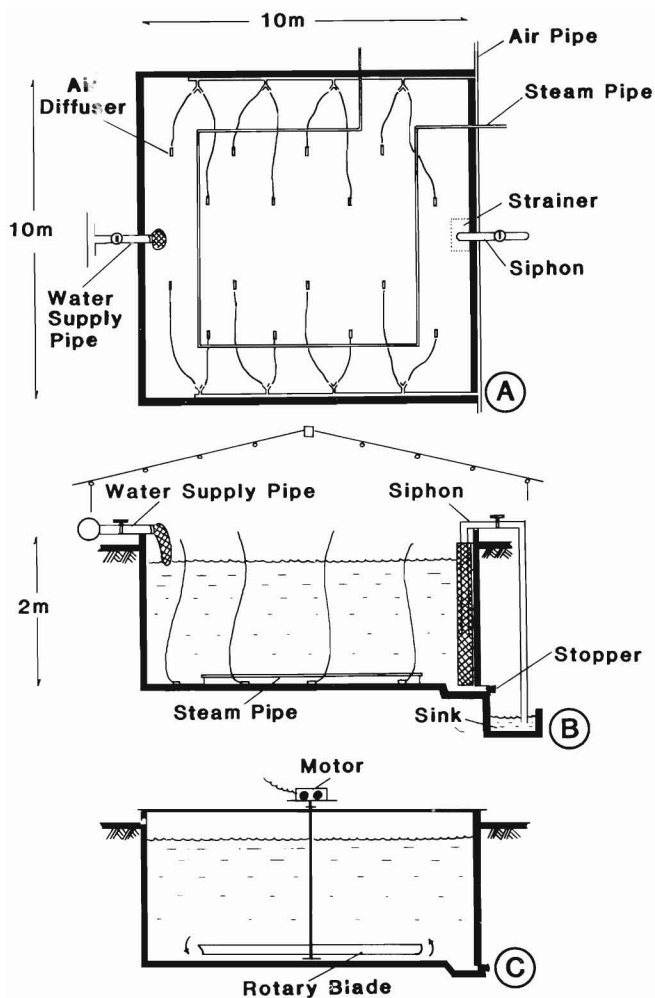

Figure 4.—Layout of Kuruma shrimp fry production tank. A, floor plan; B, cross section; C, tank with a rotary blade.

shrimp reach the postlarval stage, the water will almost fill the tank. Afterwards, one-third to one-fifth of the water is renewed daily according to its degree of deterioration.

Foods and feeding.—Diatoms, such as *Skeletonema costatum* or *Chaetoceros simplex*, are supplied to the protozoae either by direct enrichment of the rearing water with nutrient salts or by introduction from other culture tanks. The direct enrichment method is not always reliable in summer when the temperature of the rearing water may exceed 30°C and during the rainy season when the available solar energy is limited. The optimum density of the food diatoms is between 30,000 and 100,000 cells/ml. Frozen algal feeds and trochophore larvae of oysters may also be used successfully.

During mysis and early postlarval stages, a variety of animal feeds are used in addition to diatoms. *Artemia* nauplii are the most common feed for animals in these stages. About 5-8 kg of dry egg are used in the production of 1 million fry. Rotifers or bacteria may be substituted. Minced meat of bivalve mollusks and mysids are the most popular feeds for postlarvae; 120-170 kg of these, in addition to *Artemia* nauplii, are used to produce 1 million fry. The use of compound feeds for postlarvae has recently become popular.

Stocking density and survival rate.—Suitable stocking density is about 30,000/m³ for newly hatched nauplii, and 10,000-15,000/m³ at harvest of postlarva of 11-13 mm in body length and 0.01 g in wet weight. Larval development requires 10-12 d and another 20-25 d are required to reach 0.01 g postlarva. Survival rates throughout larval and postlarval development may be as high as 50% or greater, but vary to a considerable extent depending upon several factors.

Harvest and shipment.—In order to harvest, the fry are concentrated by draining the rearing water to one-half or one-third of its depth. They may then be scooped out with a dip net or flushed out along with the rearing water through the bottom drain and caught with an appropriate net. They are counted by measuring either wet weight or volume and shipped in plastic containers by cold storage trucks equipped with an aerating device. About 700,000 fry may be kept in a 1 m³ container for 10-12 h without serious ill effects.

Problems.—Deterioration of the midgut gland may occur during the early postlarval stage. Once this is observed, all the animals in the tank will perish within a week. This is the only serious problem in fry production of Kuruma shrimp.

Growing Shrimp in Tidal Ponds

Facilities.—The tidal pond is the most commonly used facility in Japan for growing Kuruma shrimp. About 400 ha of coastal area, converted mostly from salt evaporation ponds, are now used for shrimp ponds. The ponds are drained during the off season in winter for 60-80 d to expose the bottom sand to the atmosphere and sunlight to ensure adequate oxidation. Predatory fishes are eliminated by applying piscicides before the shrimp fry are released.

The pond areas range from 0.5 to 5.0 ha. Small ponds are used as nurseries. For growing, however, large ponds are preferable because they can be managed at a lower cost per unit area than smaller ponds. In large ponds, a canal system is constructed running from the periphery toward the sluice gate. The exchange of pond water is effected by the movement of tides. Usually about one-third of the pond water is changed daily either during the day or night. The rate varies according to the ambient temperature, oxygen content, and concentration of diatoms in the pond water. Exchange of pond water is limited during each neap tide for 3-4 d. The sluice gate is accompanied outside by an iron lattice to keep out large seaweeds and other floating material; inside a fine mesh screen fence prevents loss of shrimp and intrusion of predatory fishes.

An aeration system or mechanical agitation is used to mix surface water and to supply oxygen. The deterioration of the bottom condition may be improved to some extent by stirring bottom sand with a water jet or by treatment with iron oxide at a density of 60-120 g/m². Seaweed is controlled by maintaining diatom populations at an appropriate level.

Growth management.—To maximize productivity per unit area, several technical improvements have been made in recent years, although no final answers are presented. At present, three types of management plans are practiced among tidal pond culturists in the Seto Inland Sea area. They may be called one-crop, two-crop, and multicrop plans according to the number of cropping times per year as illustrated in Figure 5 A-C. In any

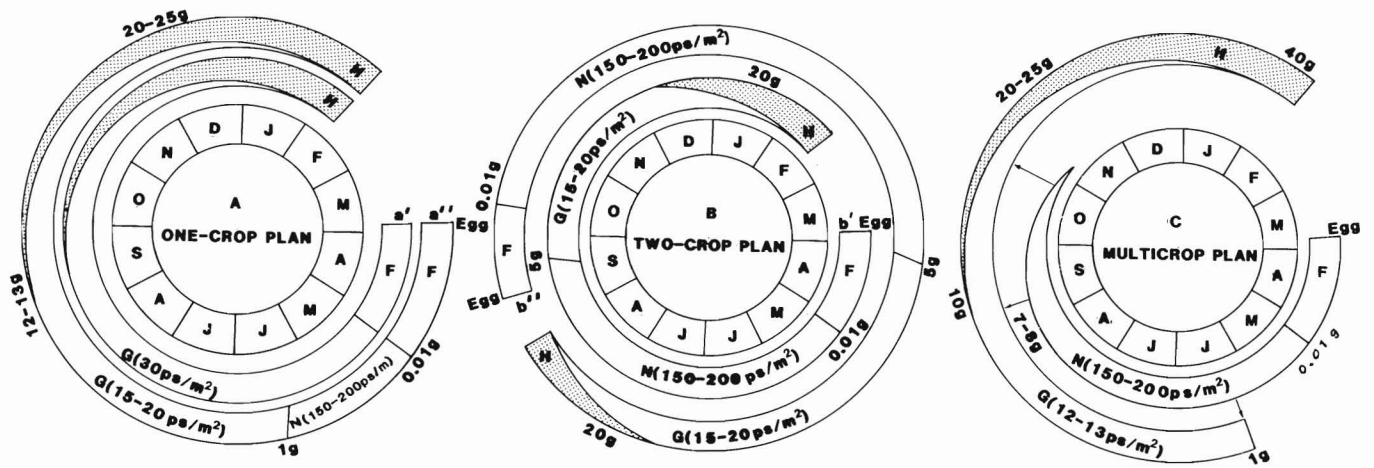

Figure 5.—Kuruma shrimp culture plans in tidal ponds in the Seto Inland Sea area. F, fry production; N, nursery; G, growing; H, harvest.

method, however, the maximum carrying capacity is around 200-250 g of shrimp/m². It is a basic principle of growth management to keep the stocking density below the carrying capacity by thinning out the population at appropriate times.

One-crop culture is the original type of culture. Figure 5A shows that in this plan 0.01 g fry are directly released into the culture pond in May (a'), or 1 g fry that have been precultured in other nursery ponds at a density of 150-200/m², are stocked in the culture pond in June at 15-20/m² (a''). In both cases, fast-growing shrimp may attain 12-13 g each by September with a survival rate of 70-80%, which approaches the maximum carrying capacity. The large shrimp should be removed by installing pound nets along the periphery of the pond to allow the remaining shrimp further growth. By November, 20-30% of the population is removed and sold. The rest of the surviving shrimp, now attaining 25-30 g each, are harvested in full scale from November until February. Total annual productivity is 3 t or less per hectare.

In the two-crop plan (Fig. 5B), the culture process is carried out in two series of four steps each—fry production, nursery, growing, and harvest—in succession during alternate months of the year with the same set of facilities, thus maximizing annual productivity per unit area. Shrimp are cropped twice a year during July-August and December-February.

In the multicrop plan (Fig. 5C), 1 g fry are released in the culture pond at a lower density (12-13/m²) than usual to allow them to grow as fast as possible. As soon as the fast-growing shrimp attain 10 g in early August, the farmer begins harvesting large shrimp and subsequently releases additional juveniles from the nursery ponds. This procedure is repeated almost every day until the end of October. From November to February, effort is concentrated in the final growing and full-scale harvest of larger shrimp without additional stocking. The total harvest may reach 3.0-4.5 t/ha per yr.

Foods and feeding.—The short-necked clam and blue mussel have been the main feeds used in Kuruma shrimp culture. Their use, however, has been seriously limited in recent years owing to their short supply and enormous increase in price. A variety of substitutes are used today including small-sized shrimp, mysids, krill, squid, oysters, and several kinds of fish with white meat. These are stored frozen and used in combination. In addition to these, several kinds of compound diets are now available at

reasonable cost. They were originally developed as an integral part of Shigueno's method. Recently, however, as much as 30-40% of the total feed consumption in tidal pond culture has been supported by these pellets.

Daily food consumption varies greatly depending on the size of the shrimp. Smaller shrimp consume much more feed than larger ones in relation to their own body weight. Figure 6 shows the standard daily rations by shrimp size. When pellets are used, about one-sixth of these amounts may be taken as standard allowing for the moisture content.

Food conversion ratios range from 14 to 15 when frozen feeds are used. A similar value can be expected with pellets when moisture content is taken into consideration. In tidal ponds, natural benthic organisms may constitute supplementary feed for Kuruma shrimp, but the quantity of benthic organisms is too low to support the shrimp in any appreciable densities.

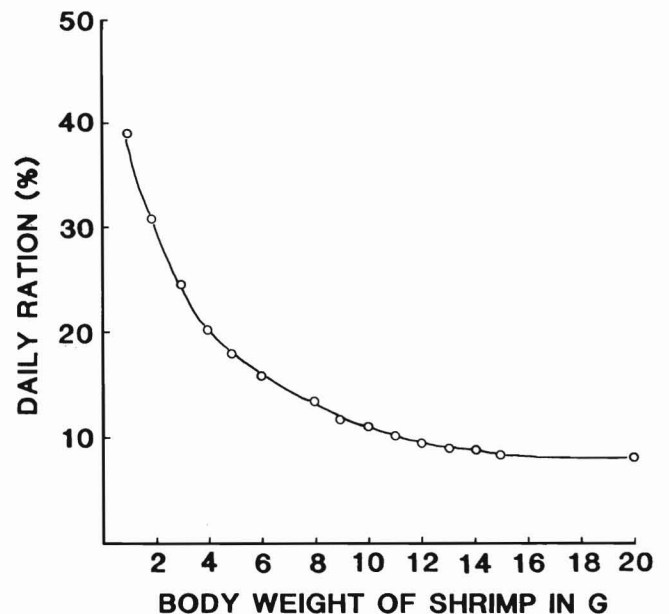

Figure 6.—Daily rations of Kuruma shrimp in percentages of their own body weight.

Harvest.—Cultured shrimp are harvested by either of the following two methods. During the warm season they are effectively captured at night by pound nets installed at right angles to the dikes of the pond. After the water temperature falls below 15°C in early December, the shrimp become dormant and are harvested with drag nets equipped with either a water jet or an electric shocker.

Growing Shrimp in Concrete Tanks

Layout of tank.—A circular concrete tank, 36 m in diameter and 2.5 m in depth at the periphery, is recommended as a standard unit. Figure 7 shows a culture tank in cross section. Seawater is constantly circulated at a peripheral linear velocity of about 10 cm/s. Movement of water is effected by two or three 1 hp motor driven wheels or a series of oblique water sprays from a pipe, whose length equals the tank diameter, above the tank. Since it is a continuous flow-through system, it is desirable to have a pump capacity at least 5 times the holding capacity of the tank.

A layer of fine sand about 10 cm thick is held slightly above the bottom of the tank by plastic spacers and a sheet of synthetic fiber net. The tank floor ascends from the periphery toward the center at a slope of 2/100 to minimize loss of sand from the central drain. The central drain automatically removes any deposits and suspensions of organic detritus, food residues, feces, and molts. These are carried toward the center of the tank by centripetal force created by circular movement of the tank water. This system is most effectively operated at night when bottom sediments are stirred up by active movement of shrimp. During the day when shrimp remain buried in the sand, the central drain is closed and the draining is effected through other routes which run from midway between the center and periphery and under the sand layer. This allows a flow of seawater through the sand bed and keeps it aerobic. The quality of water and sand beds is managed by manipulating the water supply and draining route. The general practice is to exchange more water at night than during the day. The tank water should mature for 4-5 d before releasing the fry. During this time, the water turns light brown due to the growth of diatoms.

Culture management.—During the nursery stage, as many as 400-600 fry/m² are stocked and cultured for about 50 d until they attain 0.7 g each with an average survival rate of 80%. The stocking density is then adjusted to about 160 juveniles/m² by transferring some shrimp to other tanks where they enter the growth stage. By the end of October, the shrimp reach 10 g each and the stocking density approaches the maximum carrying capacity of 1.5 kg/m². It is essential at this stage to reduce the population by

20-30% to ensure further growth of the remaining shrimp and to maintain the overall survival and food conversion ratio at reasonable levels. Through proper management, almost 70% of the original number of shrimp may be cultured up to 20-25 g each by March with a maximum production of 2.7 kg/m².

Foods and feeding.—In Shigueno's culture method, the shrimp are fed pellets, which are produced and sold from several factories in Japan. Not all the pellets now on sale are adequate for intensive culture, but the best quality ones promote satisfactory growth, survival rates, and visual appearance of the final products at a reasonable cost.

Figure 8 shows feeding and growth of shrimp in two of the typical culture practices carried on after Shigueno's method in 1979 at a shrimp farm in Kagoshima. The shrimp are fed once a day after dark when they actively search for food. Fresh frozen feeds, comprising about 2% of the total amount, are used just before harvest to produce a desirable color in the final product. The overall food conversion ratio averaged approximately 2.5 dry weight of pellet to wet weight of shrimp.

Harvest.—A drag net with an electric shocker is effectively used to harvest the shrimp. However, approximately the last 5% of the shrimp have to be picked up by hand, one by one, from the sand bed after draining the water from the tank.

SHIPMENT

The harvested shrimp are held in chilled seawater in a dark room for a couple of hours before being packed. This process minimizes shrimp metabolism and enhances their hardness for out-of-water viability. They are then sorted into size groups and packed in a carton sandwiched in chilled sawdust. One package contains 2 kg of live Kuruma shrimp and almost equal amounts of sawdust. These are packed and sealed in a large carton and are then ready for shipment. Kuruma shrimp are usually flown from the production sites to Tokyo, Osaka, and other urban consumption centers and brought to the consumers while still alive on the day following harvest.

MAJOR TECHNICAL PROBLEMS

A major technical problem in growing Kuruma shrimp in tidal ponds or Shigueno's tanks is the occurrence of heavy mortality during the summer due to disease among the growing animals. The most common symptom, which is usually followed by serious mortality, is the deterioration of gills by infection with fungi or

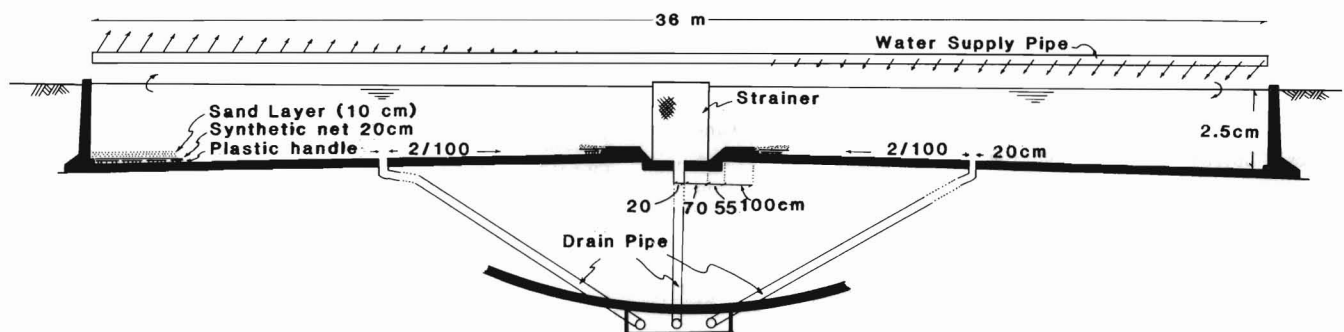

Figure 7.—Diagram showing the structure of a Shigueno type concrete tank for growing Kuruma shrimp.

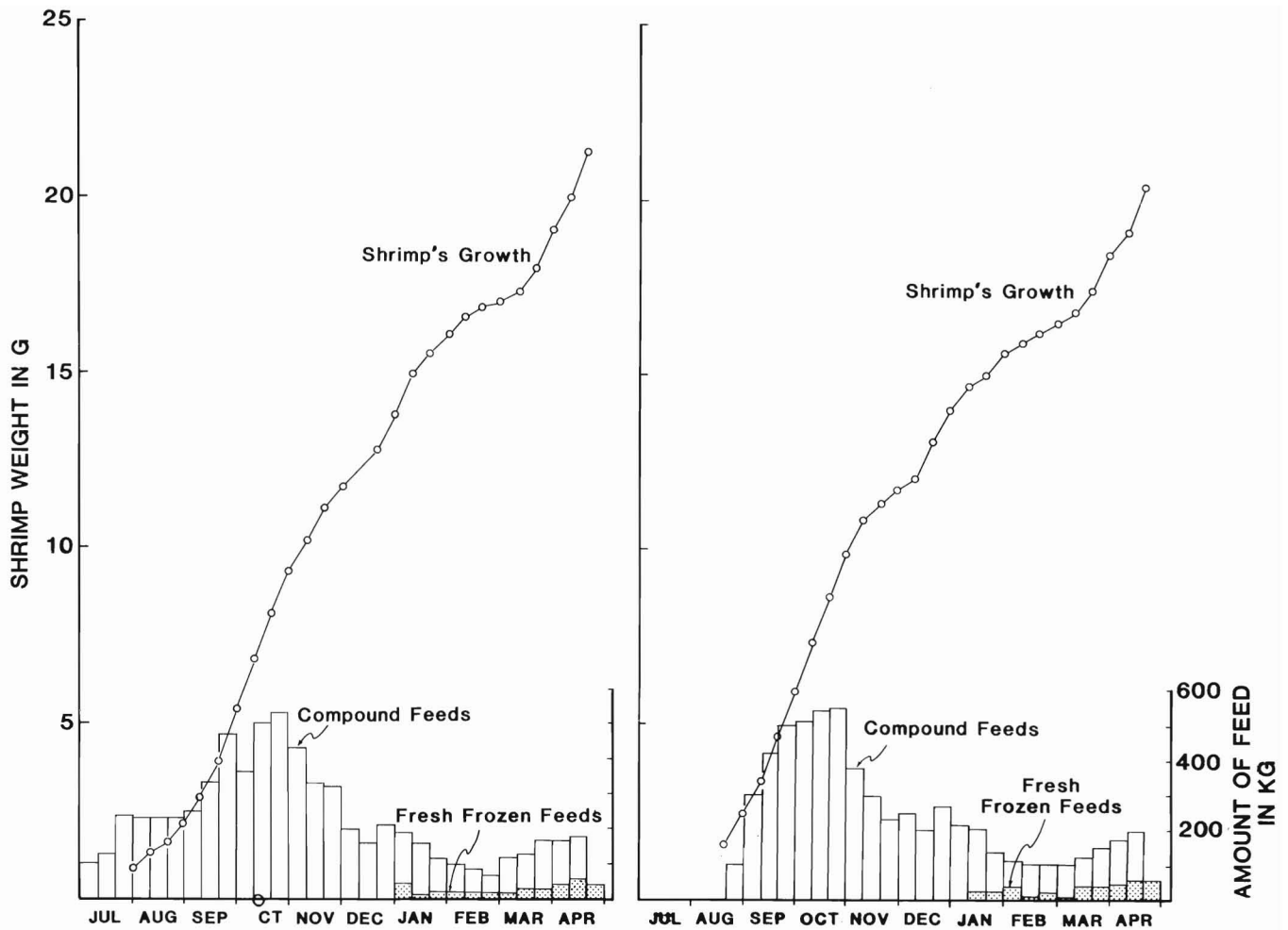

Figure 8.—Feeding and growth of Kuruma shrimp in the Shigueno type growing tank. Fresh frozen feeds are euphausiids and shrimps and are used to produce a desirable color in the final product.

bacteria. The major cause is believed to be the excess stocking density combined with pollution of bottom sediments due to accumulation and decomposition of organic wastes.

COST AND PRODUCTIVITY

It is somewhat difficult to analyze commercial cultivation from an economic viewpoint, since the availability of reliable financial data is limited and, in addition, the economic situation is affected by a number of variables. The data presented in Table 1 are approximations estimated from various sources. Nevertheless, these data show that the production cost per kilogram of shrimp is cheaper, for the present at least, in tidal ponds than in Shigueno's tanks owing to a smaller expense for power and fuel in the former. Productivity, however, is greater in Shigueno's tanks than in any tidal pond on both a per unit area and per man basis. Other advantages of Shigueno's method over the tidal pond method are: 1) The ease of various aspects of culture management, thus saving on wage costs, 2) the capability of shrimp cultivation in localities where tidal and topographic conditions are not suitable for the construction of tidal ponds, 3) the applicability of maximum utilization of warm water effluents from electric power plants or other sources, and 4) the potential of providing a strong impetus toward the development and improvement of high quality pellet feeds.

Table 1.—Cost and productivity of Kuruma shrimp culture.

Type of culture	Shigueno type	Tidal pond type	
Total cost per kg	¥ 5,000	¥ 2,900-4,600	¥ 2,930
Feeds	39.3%	29-35%	41%
Power and fuel	14.0	3	3
Interest	14.0	4-10	5
Wages	9.3	18-31	18
Shipment	7.1	10-15	16
Depreciation	6.6	2-5	3
Seedling	0.4	2-5	1
Management	3.2	4-8	8
Repairs	1.5		
Prosperity	0.9		
Trips	0.4		
Public relations	0.4		
Others	6.0	8-11	5
Part-timers wage	2.6		
Commodities	1.5		
Chemicals	0.9		
Others	1.0		
Annual productivity			
per ha (t)	25-27	3-5	3
per man (t)	2.5-4.0	1.8-2.2	—
Source of data	Present paper	Hirasawa and Walford (1979)	Shigueno (1975)

RECENT TRENDS AND FUTURE OUTLOOK

From 1970 to 1979, the Kuruma shrimp culture industry in Japan achieved striking growth. The amount of production increased by a factor of 5 at an average annual rate of 18% from 295 t to 1,480 t and is still expected to increase; the number of farms increased 1.6 times from 77 to 120, and the total pond area increased 1.9 times from 204 to 397 ha. A much greater rate of increase in the amount of production over that of pond area is due to improvement of productivity per unit area. It has increased 2.6 times from 1.4 t/ha in 1970 to 3.7 t/ha in 1979.

Recent trends are reflected in the construction of new concrete tanks by Shigueno's method. The tank area of this type has increased at an annual rate of 24% during these years attaining 12 ha in 1979, while tidal pond areas have leveled off lately at about 400 ha. Beginning a new venture in shrimp culture in tidal ponds in Japan seems to be far from feasible today owing to the enormous rise in the cost of land coupled with the inherent low productivity. In addition, the limited availability of fresh feeds due to their high purchase and handling costs puts another constraint on the culture practice in tidal ponds, where the majority of feeds for growing shrimp depend on fresh frozen feed.

The culture techniques of Kuruma shrimp on the whole are well established and the commercial venture of shrimp culture has so far been a more or less profitable business in Japan. Its economic feasibility, however, is to a large extent supported by a high market price for live Kuruma shrimp. A growing menace to the future of this industry is the hovering trend in the price of products on the one hand and a rapid rise in production costs on the other. Efforts must be concentrated to further improve productivity through the intensification and rationalization of culture

practices and enhancing the survival rate which, in turn, will require refinement in the quality of compound feeds and in the techniques of bottom sediment management.

To meet the economic demands of commercial shrimp culture under a controlled environment, another means of low cost shrimp production has been explored. The most promising is the farming of the edge of the sea by releasing a large number of artificially reared shrimp fry. The principles and techniques of this activity have already been reviewed by Kurata and Shigueno (1979) and Kurata (1981). The amount of Kuruma shrimp fry production for this purpose has rapidly increased in recent years attaining a total of 450 million in 1978; it is still expected to increase as a result of the construction of new marine fish and shellfish seed production centers in the majority of prefectures throughout Japan.

LITERATURE CITED

- HIRASAWA, Y., and J. WALFORD.
1979. The economics of Kuruma-Ebi (*Penaeus japonicus*) shrimp farming. In T. V. R. Pillay and W. A. Dill (editors), *Advances in aquaculture*, p. 288-298. Fishing News Books Ltd., Farnham, Surrey, Engl.
- HUJINAGA, M., H. KURATA, and J. KITAKA.
1977. The evolution of prawn culture. In T. Imai (editor), *Aquaculture in shallow seas: Progress in shallow sea culture*, p. 411-561. New Delhi, Amerind Publ. Co. Pvt. Ltd.
- KURATA, H.
1981. Shrimp fry releasing techniques in Japan with special reference to the artificial tideland. *Kuwait Bull. Mar. Sci.* 2:117-147.
- KURATA, H., and K. SHIGUENO.
1979. Recent progress in the farming of Kuruma shrimp (*Penaeus japonicus*). In T. V. R. Pillay and W. A. Dill (editors), *Advances in aquaculture*, p. 258-268. Fishing News Books Ltd., Farnham, Surrey, Engl.
- SHIGUENO, K.
1975. Shrimp culture in Japan. *Assoc. Int. Tech. Promot.*, Tokyo, 153 p.

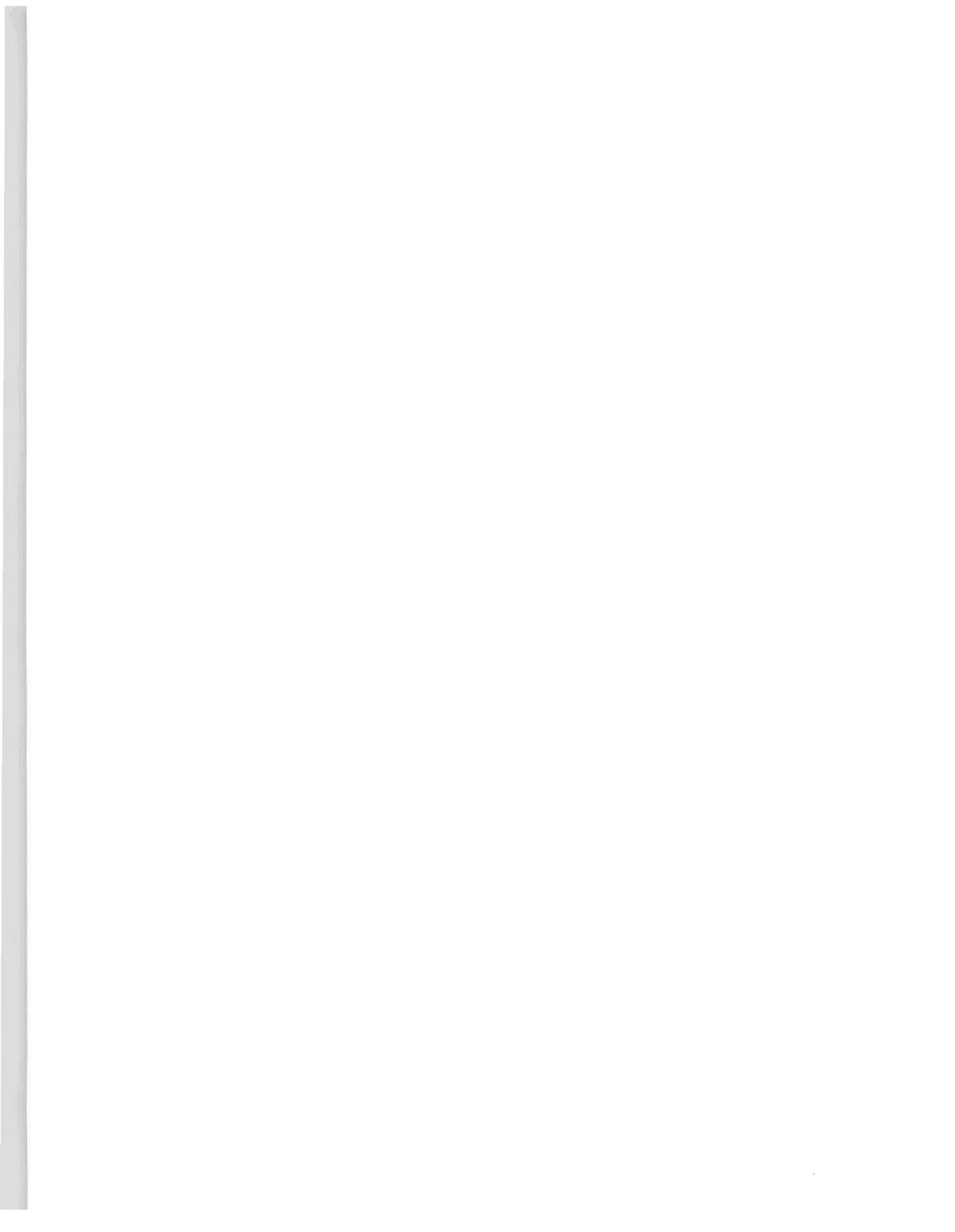

Structure of a Kuruma Shrimp Culture Pond

TOSHIFUMI NOMA¹

SHRIMP CULTURE IN JAPAN

In Japan, seafood, especially live and fresh fish, is highly valued. The Japanese prefer sea bream, lobster, and shrimp and it is not surprising that some of these species have been cultured. Culture of Kuruma shrimp, *Penaeus japonicus*, was initiated in Amakusa, Kumamoto Prefecture in 1902 (Honma 1971). Today, the shrimp are cultured in the warm districts of southwest Japan. Yearly production has been increasing; in 1979, production was about 1,500 tons (Japan, Ministry of Agriculture and Forestry 1981) (Fig. 1). The flourish of shrimp culture can be attributed to

¹National Research Institute of Fisheries Engineering, Ebidai, Hasaki-machi, Kashima-gun, Ibaraki, Japan.

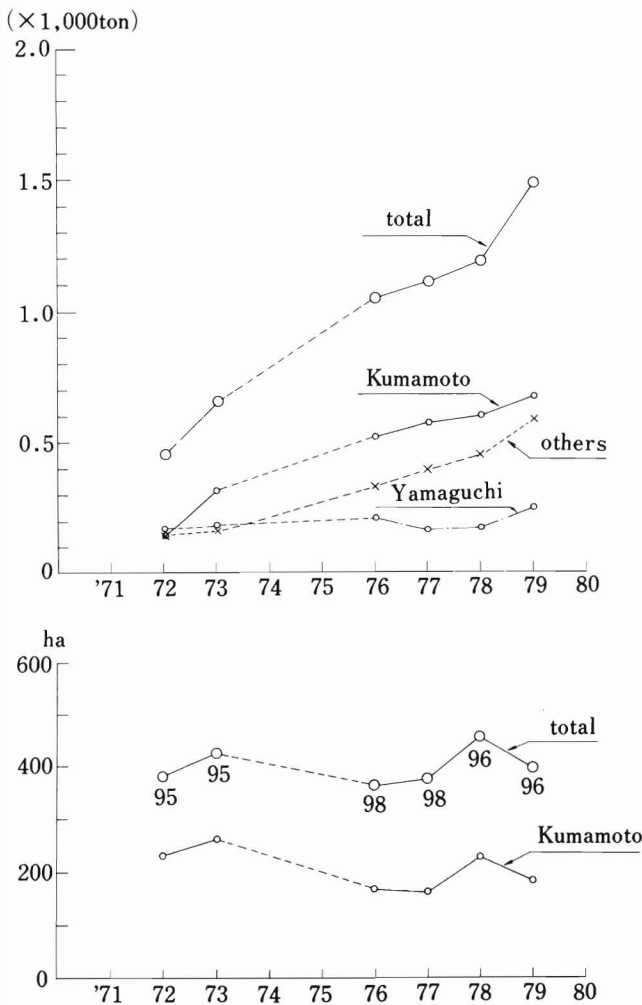

Figure 1.—Yearly changes in Kuruma shrimp culture. Top: Others = Kagoshima, Ehime, Ohita, and Okinawa. Bottom: The numbers under the total line are the percentages of embankment type ponds.

the late Dr. Hudinaga and his successors, as well as to shrimp culturists who have perfected the technique of mass production of shrimp seed.

Originally, shrimp culture was performed in net enclosure ponds (Yamamoto et al. unpubl. data). These ponds had a 100 m² surface area and were enclosed by bamboo nets (Fig. 2). Shrimp culture of this type expanded in the Amakusa district. Net enclosure ponds were often damaged by storm surges; as a countermeasure, the bases of the poles that sustained the net were strengthened by stones or concrete. Even with this improvement, they were still damaged by storm surges. An embankment was also tested, but low water exchange caused high mortality of the shrimp. In addition, this type of construction was expensive.

In 1920, the semi-embankment type was designed (Fig. 3). This type, a combination of net enclosure and submerged dyke, was less expensive compared with full embankment, had a greater water exchange rate, and had a smaller wave force acting on the poles. Today the semi-embankment type is dominant in Amakusa.

Thus, shrimp culture ponds can be classified as 1) semi-embankment type, 2) embankment type, which are converted from obsolete salt pans or kantakued paddy fields, 3) inland pond (shrimp culture tank), and 4) others. The first two use tidal energy for water interchange and exchange; the third uses a mechanical pump.

Figure 4 shows the relationship between yield and surface area of pond in Amakusa in 1970 (Yamamoto et al. unpubl. data). The yields varied from pond to pond and ranged from 100 to 300 g/m². After 1970, the yield in the district gradually increased as shown

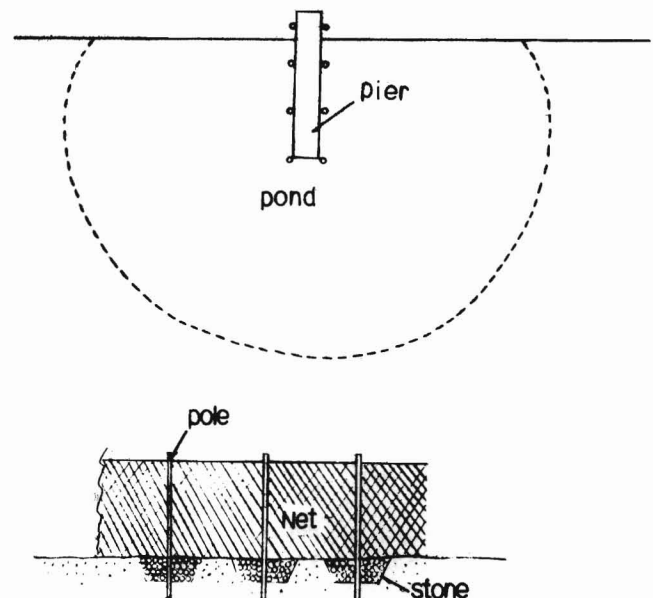

Figure 2.—Net enclosure.

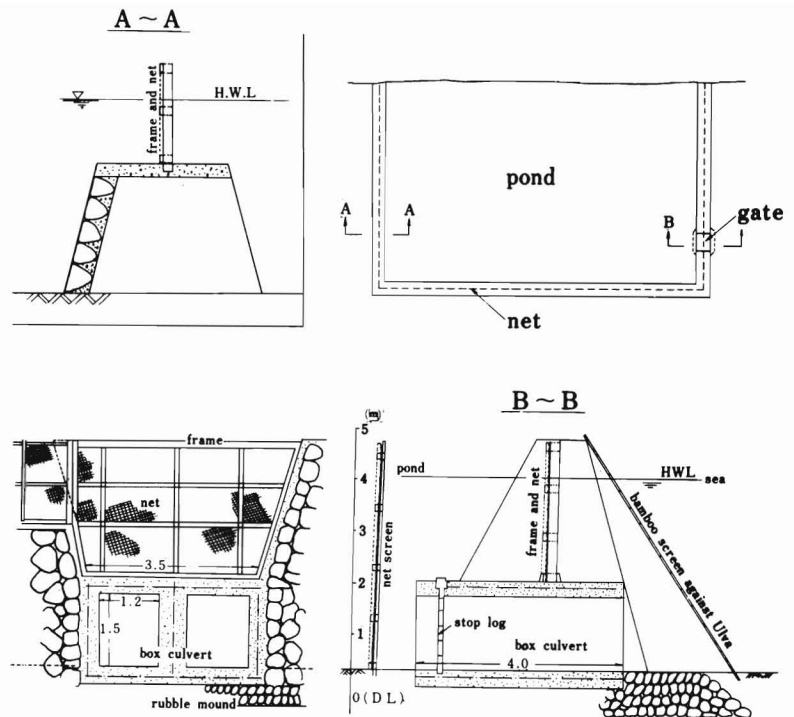

Figure 3.—Semi-embankment pond.

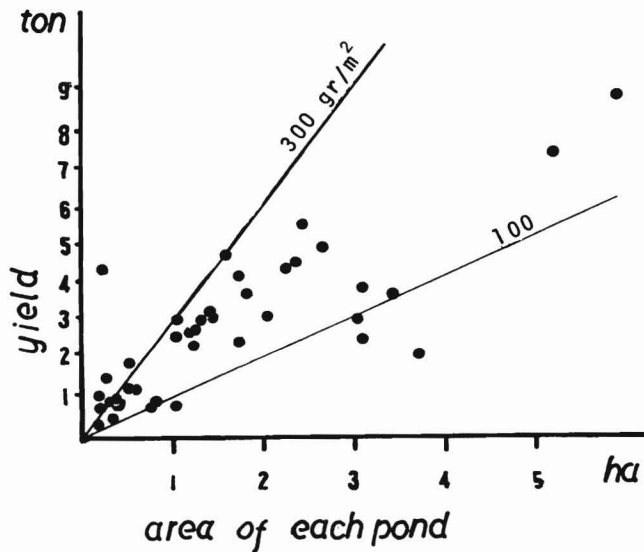

Figure 4.—Yield and area of ponds, Amakusa, 1970.

Table 1.—Yearly change in production in Amakusa. Total pond area = 159.5 ha. Average annual production = 374 g/m².

Year	Tons
1974	510
1975	513
1976	517
1977	573
1978	596

Table 2.—Types of pond and yield.

Pond type	Yield (g/m ²)
Semi-embankment	400
Embankment	400
Tank culture	2,500

in Table 1, and production per unit area reached 400 g/m². Production per unit area of each type is shown in Table 2. Production per unit area in tank culture is the highest and can be attributed to pond management.

FACTORS TO CONSIDER

In planning a shrimp culture pond, many factors need to be considered (Kurata and Shigueno 1976; Shigueno 1969) including 1) natural conditions such as climate, topography, tide, and risk of storm surges, and 2) socioeconomic conditions. The pond is designed to meet the requirements of the shrimp and to facilitate pond management. The shrimp require food, living space, DO

(dissolved oxygen), adequate water temperature, and a clean and soft sand bed which allows easy burrowing.

Pond management activities are listed in Table 3. Before the shrimp fry are introduced into the pond, the substrate is ploughed repeatedly to oxidize the bed materials; deteriorated sand may be replaced; and predator fishes are eliminated. The facilities are repaired and, on occasion, sand will be supplemented.

In embankment type ponds, water is let into the pond about 10 d before the fry are introduced. The water is controlled to allow propagation of diatoms to an adequate density.

Table 3.—Management activities.

Preparatory activities	
	Oxidation of sand bed (chemical sterilization in tank culture)
	Substitution of bed materials
	Repair of facilities
	Predator control
	Water curing
Activities during the rearing period (include the prestocking rearing)	
	Feeding
	Water quality control
	Ulva (<i>Ulva lactuca</i>) control
	Predator control
Harvest (with pond net or dragnet with electric shocker)	

In April and May, the shrimp fry are introduced into the pond. This period is also the spawning season of the predator fishes, sea bream (*Pagrus major* and *Acanthopagrus schlegelii*) and goby (*Tridnietiger obscurus*). Eggs, 0.8 mm in diameter, of predator fishes enter the pond through the net screen. After hatching, the juveniles of predators grow more quickly than shrimp fry. When the juveniles become bigger than the fry, they start to devour the fry. To prevent egg intrusion, net screens with fine mesh even smaller than the egg's diameter is sometimes used. The penetration of the noxious ulva (*Ulva*) and its subsequent decomposition cause serious deterioration of the water and bottom soil. This is partly inevitable.

Because of predation and ulva, shrimp culture in the same pond should be as short as possible. Therefore, pre-stocking rearing, i.e., in nursery ponds, is adopted. The nursery pond occupies 10 to 20% of the whole pond area and can be easily managed. Swarming of ulva is now checked by inducing and maintaining a bloom of unicellular planktonic algae such as diatoms. Sometimes ulva may be scooped out or eliminated by chemicals (RADA).

The fundamental requirements and engineering items for a shrimp culture pond are shown in Table 4. In Japan, the type of enclosure is generally determined by the importance of disaster prevention. If storm surges occur, the embankment type is adopted. The embankment may, however, cause deformation of the shoreline, erosion, or sand accumulation. Therefore, careful consideration is needed before adopting this type of enclosure.

Water depth can be maintained at about 1 m in the summer. The bottom elevation is M.L.W.L. (mean low water level) and m.s.l. for tank culture. The minimum thickness of the sand bed is 10 cm.

The dimension of the water gates is determined from the exchange flow rate needed and the ability to flush out drifted sand around the water gate (Gyoko-Senkai Kaihatsu Consultant Co.²).

²Gyoko-Senkai Kaihatsu Consultant Co. 1976. Consultant report on the planning of Himeshima Shrimp Culture Pond. Unpubl. rep.

Table 4.—Fundamental requirements for a shrimp culture pond.

Requirement	Engineering item
To hold the animals	Enclosure, sand bed
To have a high rate of seawater exchange, and the ability to flush out organic matter	Flow velocity
To be able to maintain adequate water depth	Gate and submerged dyke
To protect from predator fish	Screen net
Other	Access for bulldozers into the pond

Concerning the latter, a maximum flow velocity > 0.4 m/s is adopted in Himeshima.

Net screens consist of a net fence for protection against drifting material and a fine net for protection against predator fishes. Fine net of 2 mm mesh is used in nursery ponds and 3 mm mesh is used in culture ponds.

WATER QUALITY CONTROL

In culturing shrimp, the water quality should be properly maintained. Dissolved substances affecting water quality include DO, organic matter (metabolite and food residues), NH₄, and H₂S. It is well known that DO should be maintained at more than 6 ppm:

$$\begin{aligned} \text{DO} &> 6 \text{ ppm} \\ \text{NH}_4 &< 0.1 \text{ ppm} \\ \text{water temp.} &< 30^\circ\text{C.} \end{aligned}$$

The water quality control method is essentially a promotion of the water exchange rate. For DO control, however, aeration with mechanical power is usually adopted. For hydrogen sulfide control, iron oxide can be dispersed in the pond.

If the density of phytoplankton is properly maintained, DO is supplied by the phytoplankton. Therefore, DO is controlled by the density of the plankton. In this case, the water exchange rate is determined by the coloration of the pond water.

In tank culture, flow velocity, in addition to the water exchange rate, is important. An adequate velocity is 7-15 cm/s. Less than 7 cm/s, the organic matter cannot be flushed out; beyond 15 cm/s, bed sand is moved.

To increase the water exchange rate, shallow water is preferred; nevertheless, the quality of shallow water is apt to change quickly as a result of a heavy rain or a high ambient temperature in the summer. Therefore, water depth should be properly maintained. The water exchange flow rate should be determined so as to maintain the concentrations of the dissolved substances at adequate or allowable levels.

For the semi-embankment or embankment types, supposing thorough mixing in the pond, the concentration of a dissolved substance, *M*, changes

$$V \frac{dM}{dt} = q(M_e - M) + \lambda \quad (1)$$

where *V* = water volume of the pond, *q* = effective exchange flow rate/tidal period,³ *M_e* = concentration in outer sea, *λ* = supply rate of the substance, and *t* = time. Equation (1) becomes

$$M = \left\{ M_0 - \left(M_e + \frac{\lambda}{q} \right) \right\} e^{-\frac{q}{V}t} + \left(M_e + \frac{\lambda}{q} \right) \quad (2)$$

$$M_t = \infty = M_e + \frac{\lambda}{q}$$

Figure 5 shows the graph of Equation (2). At infinite time, *M* becomes *M_e* + $\frac{\lambda}{q}$; if there is no pollution or supply, *M* approaches *M_e* as in the dotted line.

³*q* is not interchange flow rate. That is expressed by *q* = *ζ* · *S* where *ζ* = tidal range and *S* = surface area of the pond.

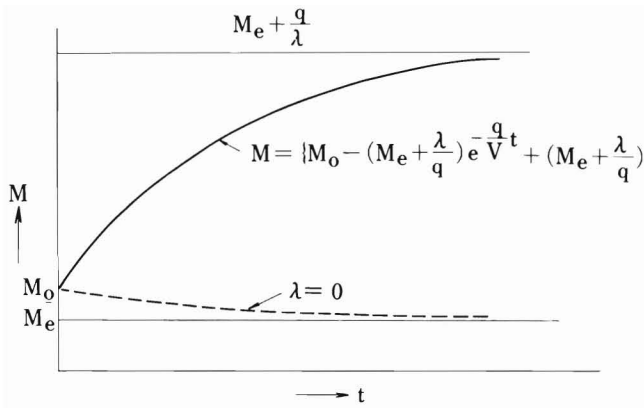

Figure 5.—Change of dissolved substances curve of Equation (2).

DO Change

Supposing there is no O_2 supply by phytoplankton, DO change can be expressed by Equation (3),

$$V \frac{dc}{dt} = K(c_s - c) + q(c_e + c) - \beta \quad (3)$$

where c = DO, c_s = saturation concentration of DO, β = O_2 consumption rate, K = coefficient of O_2 supply.

$$K = K_2 + K_s$$

where K_2 = reaeration coefficient by flow velocity, in case of Air Bubble Curtain (A.B.C.)

$$K_2 = \frac{2}{\sigma L} \sqrt{\frac{D_m u_m}{h_f^3}} (1 - e^{-\frac{\sigma L}{2}}) \quad (4)$$

where D_m = molecular diffusion coefficient of O_2 into water, u_m = maximum velocity by A.B.C., h_f = frictional depth, σ = coefficient of flow velocity attenuation ($\sigma = \frac{f}{H_f(1-2H_f)^2} \frac{1}{h}$), L = length of pond perpendicular to flow and K_s = coefficient of O_2 dissolution from bubbles (Fig. 6). Integrating Equation (3) with $c = c_0$ at $t = 0$,

$$c = \left\{ c_0 - \frac{Kc_s + qc_e - \beta}{K + q} \right\} e^{-\frac{K+q}{V}t} + \frac{Kc_s + qc_e - \beta}{K + q} \quad (5)$$

We can estimate the DO at $t = \infty$ by Equation (5),

$$c_t = \infty = \frac{Kc_s + qc_e - \beta}{K + q} \quad (5')$$

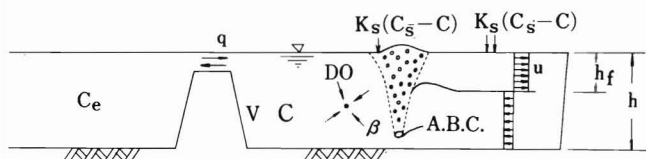

Figure 6.—Definition sketch of aeration by A.B.C.

In this case also, at $t = \infty$, DO can be given by Equation (5').

Determination of Flow Rate

Concerning the dissolved substance, M , the concentration at infinite time, $M_t = \infty$, should be the allowable one. When we know λ , the exchange flow rate can be given by

$$q = \frac{M_a - M_e}{\lambda} \quad (6)$$

$$(M_a = M_t = \infty).$$

In the same manner, for DO,

$$q = \frac{\beta - K(c_s - c_a)}{c_e - c_a} \quad (7)$$

$$(c_a = c_t = \infty).$$

Inversely, when q is given by the tidal condition, for example, we can calculate the required rate of O_2 supply, K , by

$$K = \frac{\beta - q(c_e - c_a)}{c_s - c_a}.$$

Methods

In considering the exchange flow rate using a mathematical model, there is the supposition of thorough mixing in the pond. Therefore, there should not be stagnation in the pond. Countermeasures for such stagnation include gate operation or tidal current control with a training dike (Nakamura et al. 1975).

The training dike, as shown in Figures 7 and 8, is located in reciprocal tidal currents. Downward stream flow is easy; however, upward stream flow is difficult.

The coefficients of discharge of the inlet, which is constructed with a training dike, are changed by flow condition. Tidal residual is induced in a reciprocal flow.

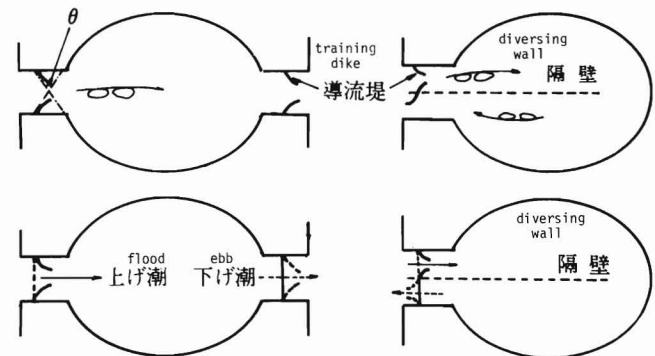

Figure 7.—Tidal current control by training dike.

EXAMPLES

Embankment Type: Himeshima Shrimp Culture Pond

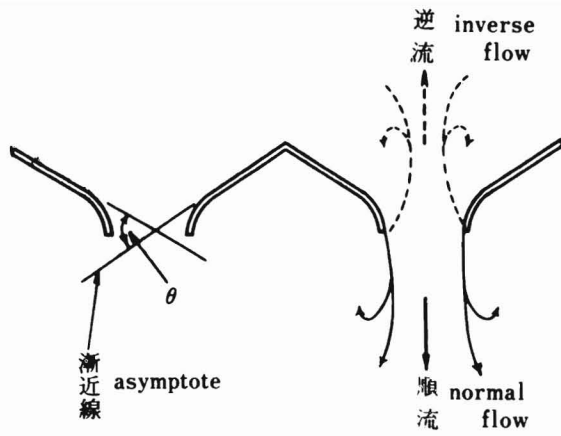

Figure 8.—Configuration of a training dyke.

Figure 9 shows an embankment type culture pond converted from a kantakued paddy field. There are four ponds, each with a 2 to 2.3 ha surface area and two gates. When the tide is rising, the upper side gates are opened to let water into the pond; when the tide is falling, the lower gates are opened. Thus pond water generally flows one way. Bottom elevation is indicated as +0.0, +0.7, etc. Each pond can be drained at mean spring low water level and is accessible to ploughs and cultivators.

Figure 10 illustrates the structure of a gate. The pond is on the left side. A fine mesh (0.6 mm) net screen, smaller than the egg size of predator fishes, is set in this portion. It is well brushed in the ebb of spring tides.

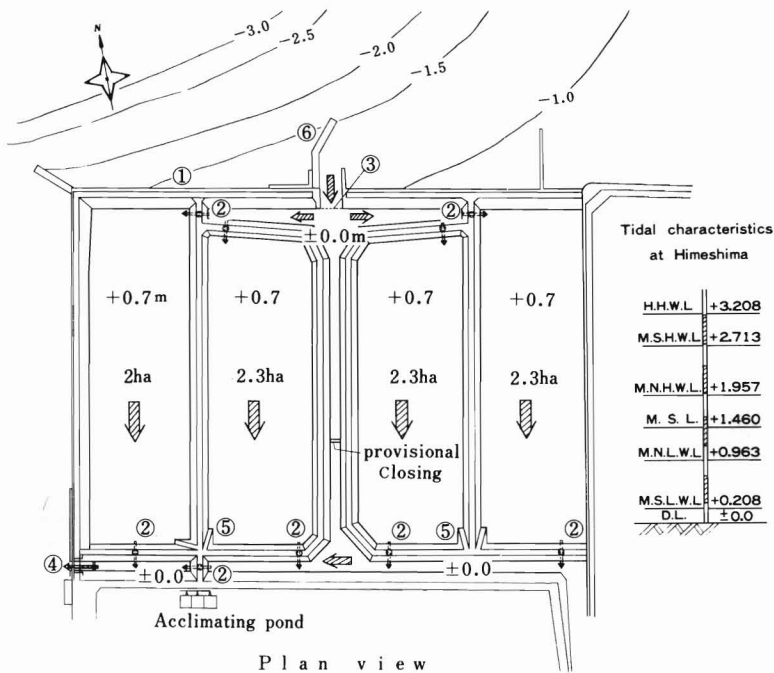
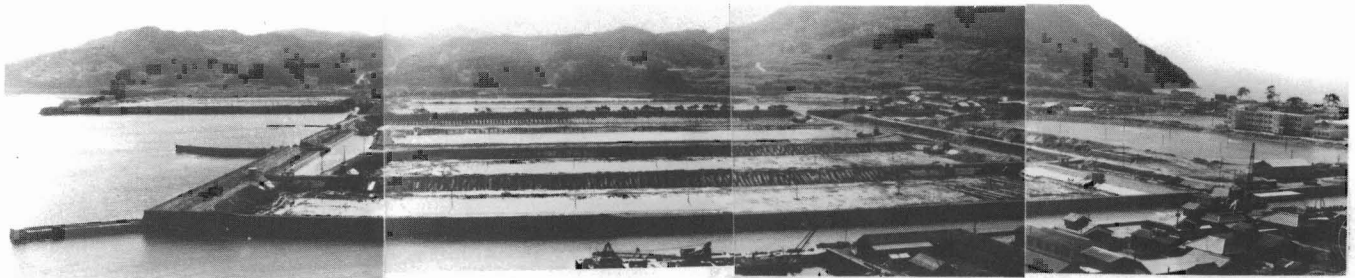

Figure 9.—Plan view of Himeshima shrimp culture pond.

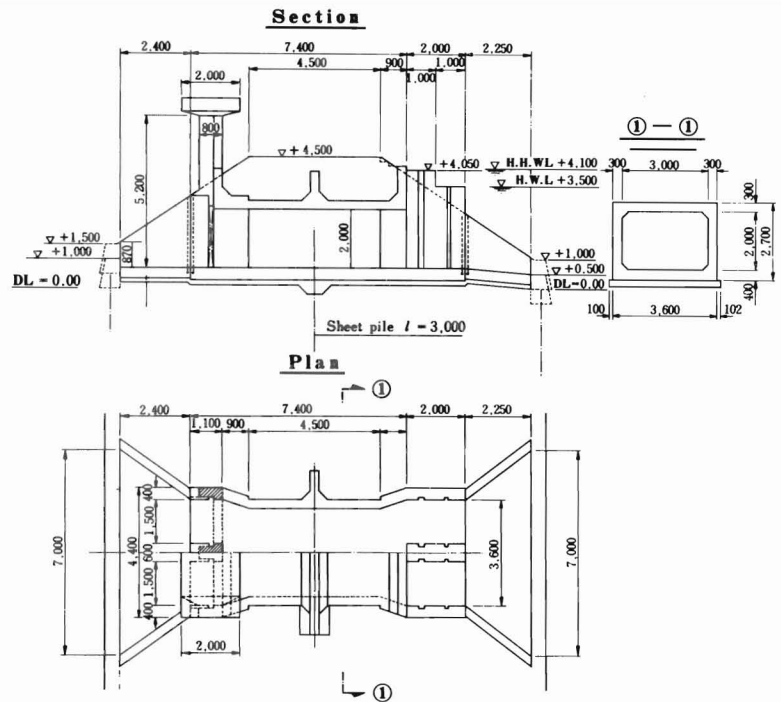
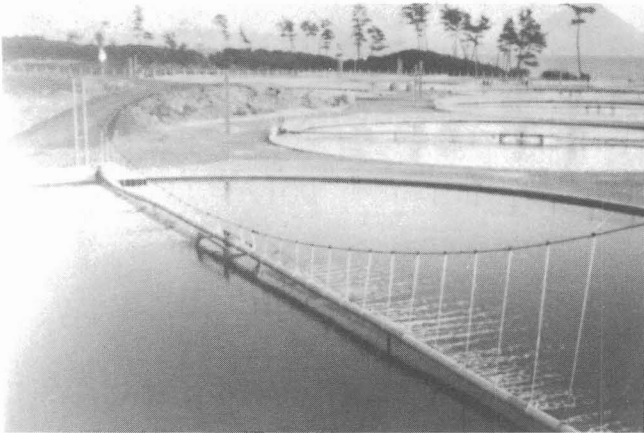

Figure 10.—Structure of gate.

Shrimp Culture Tank: Mitsui-Nohrin Inc.



ACKNOWLEDGMENTS

Many people have helped in various ways during the preparation of this paper. I am grateful to Mr. Nakamura, Kumamoto Prefecture Fisheries Experiment Station and to Mr. Fujita, Tarumizu Aquaculture Center of Kagoshima Prefecture Fisheries Experiment Station who sent me reprints and references.

I am indebted to Mitsui-Nohrin Co. and Himeshima Kuruma Shrimp Culture Co. who have permitted the reproduction of their photographs and figures.

LITERATURE CITED

- HONMA, A.
1971. Aquiculture in Japan. Japan FAO Association.
JAPAN, MINISTRY of AGRICULTURE and FORESTRY.
1981. Statistical yearbook of fisheries and aquaculture for the year 1979. Ministry of Agriculture and Forestry, Tokyo.
- KURATA, H., and K. SHIGUENO.
1976. Recent progress in the farming of Kuruma shrimp (*Penaeus japonicus*). In T. V. R. Pillay and W. A. Dill (editors), *Advances in aquaculture*, p. 258-268. FAO Technical Conference on Aquaculture, Kyoto, Japan, 26 May - 2 June 1976.
- NAKAMURA, M., S. HAGINO, and T. NOMA.
1975. A proposal of pollution control by training dike. UMI to SORA, vol. 50.
- SHIGUENO, K.
1969. On Kuruma shrimp culture technique.



Major Diseases Encountered in Controlled Environment Culture of Penaeid Shrimp at Puerto Peñasco, Soñora, Mexico

D. V. LIGHTNER, R. M. REDMAN, D. A. DANALD, R. R. WILLIAMS,¹
and L. A. PEREZ²

ABSTRACT

A number of diseases have played a significant part in the evolution of controlled environment culture of penaeid shrimp, as developed by the Universities of Arizona and Sonora at their research facility in Puerto Peñasco, Soñora, Mexico. Among the etiologies of those diseases are viruses, bacteria, fungi, algal toxins, and nutritional imbalances. Of the 20 or so diseases or conditions observed at the facility, 11 (filamentous gill disease, ciliate gill disease, *Fusarium* disease, black death, three forms of bacterial disease, larval mycosis, blue syndrome X, hemocytic enteritis, and MBV disease) are discussed here in terms of their etiology, epizootiology, and the preferred methods of treatment and prevention.

INTRODUCTION

Controlled environment aquaculture (CEAq) of penaeid shrimp by the Environmental Research Laboratory of the University of Arizona began in 1972 as an evolutionary product of the controlled environment agriculture technology developed by the Laboratory. The research facility, located on the northern Gulf of California near Puerto Peñasco, Soñora, Mexico, is a cooperative project of the Environmental Research Laboratory and The Center for Scientific Investigations and Technology (CICTUS), at the University of Sonora (Fig. 1). As a result of progress within the past several years (Salser et al. 1978), the project is now moving from the "pilot-plant" phase to a fully commercial phase. A 10 ha CEAq facility is planned for Hawaii, with construction to begin in 1981.

CULTURE METHODS

Broodstock, consisting of populations of laboratory-reared F₁ or F₂ generation *Penaeus stylirostris* or captive wild shrimp, are held in special raceways for maturation. Diet, water, temperature, and photoperiod are all controlled and monitored. Fertilized females are collected as needed and transferred to the hatchery for spawning. Egg hatching and larval culture is accomplished by modifications of the procedures described by Mock and Murphy (1970) and Mock et al. (1980).

The postlarvae are transferred to a fiber glass flow-through nursery system until they reach 10 to 50 mg. From the nursery, postlarvae are transferred to a postnursery system, a miniature raceway, where they are stocked at 500 to 1,000/m² and remain until they have reached 0.5 to 2 g. Finally, they are transferred to a growout raceway system where they are stocked at a density of 150 to 250/m². They will spend 20 to 25 wk in this growout system and are usually harvested at approximately 21 g (35 count).

The first research aquacells were remodeled greenhouses. These structures were 7 m wide × 30 m long with a 0.9 m center concrete walkway. Polyvinyl liners were installed to create two 3 × 23 m raceways of approximately 0.3 m depth, in each inflated plastic structure. The structures were covered with an ultraviolet-stabilized 10 mil polyethylene film which was inflated to form a 7 × 30 m half cylinder. From these evolved the "pilot-plant" growout raceways now in use which are 0.61 × 3.4 × 62 m in dimension. In these raceways, harvest densities of commercial-size (average tail size at harvest was 31-35 count) *P. stylirostris* have exceeded 5 kg/m² of bottom area and have consistently averaged over 3 kg/m². Total production of the 18 raceways (or 0.4 ha of water surface) in the commercial prototype was 80,000 lb or about 45,000 lb of tails for the first year of operation. Tail

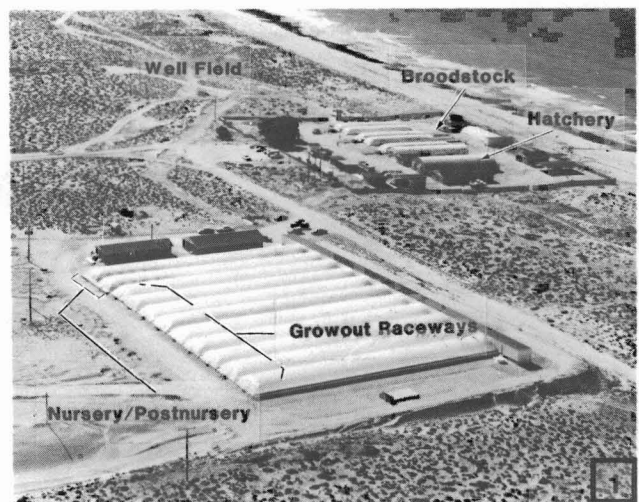

Figure 1.—Aerial view of the Universities' of Arizona and Sonora shrimp culture research facility at Puerto Peñasco. The locations of the seawater wells, the broodstock raceways, the hatchery, nursery/postnursery, and the growout raceways are indicated.

¹University of Arizona, Environmental Research Laboratory, Tucson, AZ 85706.

²University of Sonora, CICTUS, Hermosillo, Sonora, Mexico.

production for the second year of operation (1979-80) will exceed 60,000 lb.

Seawater supplying the Puerto Peñasco facility is pumped from a series of seawater wells that are placed in the sand dunes above the high tide mark on the beach to provide filtered seawater of nearly uniform quality and temperature, regardless of season.

DISEASE AND CONDITIONS ENCOUNTERED

Nearly 20 diseases or diseaselike conditions have been observed at Puerto Peñasco in CEAq systems. Many of these diseases were reviewed by Lightner (1975, 1977), but others have since been recognized. Listed in Table 1 are the most important diseases encountered at Puerto Peñasco in CEAq-reared shrimp that have resulted in the loss of significant numbers of shrimp.

Filamentous Gill Disease

One of the main problems which has received a major research emphasis at Puerto Peñasco has been filamentous gill disease (FGD). This disease is caused by a filamentous blue-green

algaelike organism that is very similar or identical to *Leucothrix mucor* (Fig. 2). All four species of penaeid shrimp (*Penaeus stylirostris*, *P. californiensis*, *P. vannamei*, and *P. monodon*) reared at Peñasco are affected by this disease. *Penaeus californiensis* is the most severely affected by the disease, while *P. stylirostris*, *P. vannamei*, and *P. monodon* are more resistant.

Leucothrix mucor is a common ubiquitous estuarine and marine microorganism of uncertain taxonomic position (Brock 1974). It attaches to living and nonliving solid substrates (Sieburth 1975) and in shrimp culture systems it readily attaches to the surfaces of the gills and accessory gill structures. It is not invasive and causes no demonstrable pathology to these surfaces (Lightner 1975, 1978b). When present on the gills in large amounts, it can impede water flow across the gills and reduce oxygen exchange. Debris, uneaten food material, algae, and fecal material may become trapped by the *Leucothrix* filaments on the gills and complicate the condition. Mortalities due to *Leucothrix* infestation of the gills are thought to occur from hypoxia. Under conditions of stress due to crowding, molting, or low oxygen levels, *Leucothrix* may cause severe losses overnight. If left untreated, FGD can cause a continuous steady, low level mortality.

FGD may be managed by the use of a copper compound applied on a scheduled, or on an "as needed," basis. A seawater-soluble

Table 1.—Major diseases encountered at Puerto Peñasco and present control methods.¹

Disease	Etiology	Control Measure
Gill disease		
1) Filamentous gill disease	<i>Leucothrix mucor</i> and various other filamentous forms including <i>Cytophaga</i> sp., and <i>Flexibacter</i> sp.	Cutrine (at 0.1 mg Cu for 24 h or 0.25 to 0.5 mg Cu/l for 4 to 8 h).
2) Ciliate gill disease	Colonial peritrich protozoans (<i>Zoothamnium</i> , <i>Epistylis</i> , and <i>Vorticella</i>)	1) Formalin (at 25 to 75 mg/l for 4 to 8 h). 2) Glutaraldehyde (at 2.5 mg/l for 6 to 8 h).
3) <i>Fusarium</i> disease	<i>Fusarium solani</i>	No control methods other than use of resistant species.
4) Black death	Dietary deficiency of ascorbic acid	Supplement diet with 1 to 2g/kg of diet, or provide fresh algae.
5) Juvenile and adult bacterial diseases		
1) Septicemias	<i>Vibrio alginolyticus</i> , <i>V. anguillarum</i> , <i>V. parahaemolyticus</i> .	Antibiotics mixed with feed and fed for 14 d. 1) Terramycin at 500 to 1,000 mg/kg feed.
2) Shell disease and infected wounds	<i>Pseudomonas</i> spp., and <i>Aeromonas</i> spp.	2) Furacin or Furanace at 100 to 500 mg/kg feed. 3) Mixture of Terramycin (500 mg/kg) and Furacin, Furanace (100 mg/kg).
6) Larval and postlarval bacterial diseases	Same as above	Sanitation, disinfection, and drying of larval rearing tanks between uses.
7) Larval mycosis	<i>Lagenidium</i>	1) Malachite green at 0.006 mg/l continuous. 2) Treflan at 0.01 mg/l continuous. 3) Sanitation.
8) Blue Syndrome X (BSX)	Unknown, but suspect chlorinated hydrocarbon contamination of feed ingredients	Avoid use of feed components containing PCB's, DDT, DDE, etc.
9) Blue-green algae poisoning (Hemocytic enteritis)	Ingestion of: <i>Schizothrix calcicola</i> , <i>Spirulina subsalsa</i> , and possibly <i>Microcoleus lyngbyaceus</i>	1) Medicated feeds to control secondary bacterial infections. 2) Reduce light to prevent algal growth. 3) Control algae growth with algicides.
10) MBVD Disease	A baculovirus	1) None known except sanitation. 2) Medicated feeds to control secondary bacterial infections.

¹Summarized from Lightner (1977).

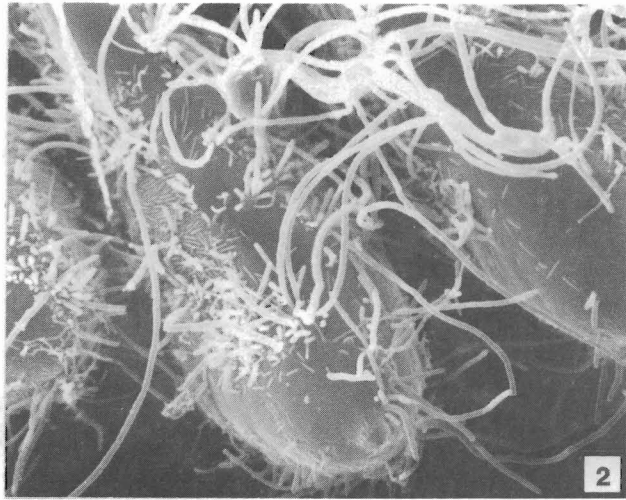

Figure 2.—Scanning electron micrograph of the gill lamellae of a blue shrimp, *Penaeus stylirostris*. The abundant long tortuous filaments present on the surfaces of the lamellae are *Leucothrix mucor*. The smaller rod-shaped organisms lying lengthwise on the gill surfaces are bacteria, probably mostly *Vibrio* and *Pseudomonas* spp. x 3,192.

copper compound, available commercially as Cutrine-Plus (Table 1) has been an effective management tool for FGD (Lightner and Supplee 1976), but even better methods of preventing or controlling FGD are needed.

Ciliate Gill Disease

Another form of gill disease that may occur alone or with *Leucothrix* is due to one or more species of the colonial peritrich protozoans *Zoothamnium* sp., *Epistylis* sp., and *Vorticella* sp. (Overstreet 1973; Lightner 1975, 1977; Couch 1978). As was the case with *Leucothrix*-caused gill disease, these organisms, when abundant on the surface of the gills, cause hypoxia and shrimp deaths by impeding respiration (Fig. 3). Like *Leucothrix*, they

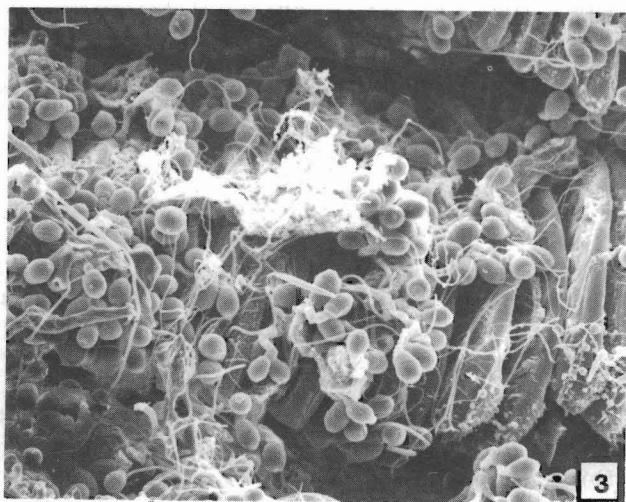

Figure 3.—Scanning electron micrograph of a secondary gill rachis of a blue shrimp, *P. stylirostris*, that is heavily infested with colonies of the colonial peritrich *Zoothamnium* sp. Also present are filaments of *Leucothrix mucor* and a few diatoms. x 199.

cause no appreciable internal damage to the gills (Lightner et al. 1975, 1977).

Formalin³ is reported to be effective in controlling these organisms in all forms of shrimp and crustacean culture (Johnson et al. 1974; Schnick et al. 1979). In CEAQ systems both Formalin and glutaraldehyde (Table 1) have been found to be effective in controlling this form of gill disease, but because of the relatively high cost of glutaraldehyde, Formalin is the preferred therapeutic (Lightner 1977).

Fusarium Disease

An important disease of adult and subadult penaeid shrimp is due to *Fusarium solani*, an imperfect fungus of world-wide distribution. Severe losses due to *F. solani* have occurred in raceway populations of *P. californiensis* and *P. stylirostris* at Puerto Peñasco. Spores of *F. solani* are present in water from the sea-water wells at Peñasco, apparently being derived from organic material in the beach sands through which the station's water is pumped. In raceway populations of subadult *P. californiensis*, the slightest wound or abrasion is sufficient to establish a fusarium infection; hence, at Peñasco, most fusarium lesions occur on the appendages, or as ulcerative lesions on the carapace, or on the pleural plates on the abdomen (Fig. 4a). "Black gills" is the most typical lesion seen in Japan in cultured shrimp infected by *F. solani* (Egusa and Ueda 1972), and this form of fusarium disease has been observed at Peñasco.

Diagnosis of fusarium disease is made by the use of a wet mount of material scraped from a suspect lesion. Demonstration of the "boat-shaped" macroconidia (Fig. 4b), which is the characteristic spore for members of the genus *Fusarium*, confirms the diagnosis.

The histopathology accompanying a fusarium infection is striking. A typical reaction to the fungus is an intense cellular inflammatory response, with the shrimp hemocytes forming large encapsulations around invading hyphae (Fig. 4c). Often, the inflammatory tissues become melanized, giving the lesion a brownish to black pigmentation.

No effective chemotherapy or preventive measures are known for fusarium disease (Hatai et al. 1974; Lightner, Moore, and Danald 1979), and mortalities due to fusarium disease in highly susceptible species such as *P. californiensis* may approach 100% (Fig. 4d). Fortunately, some penaeid species are relatively resistant to *F. solani* infections. *Penaeus californiensis* is the most susceptible to *F. solani* of the penaeid species tested so far at Peñasco. *Penaeus vannamei* and *P. stylirostris* are more resistant to infection, and are not highly susceptible to infection by *F. solani* at sizes below 20 to 25 g (Table 2). Rearing *Fusarium*-resistant species of penaeid shrimp in CEAQ systems is, at the present time, the only known method of preventing fusarium disease (Lightner, Moore, and Danald 1979).

Black Death

Black death is the name given to a nutritional disease of penaeid shrimp caused by a dietary deficiency of ascorbic acid (Lightner et al. 1977). Shrimp having black death (Fig. 5a) typically display blackened (melanized) lesions in the stomach wall, the hindgut wall, in the gills, and in the subcuticular tissues

³Reference to trade names does not imply endorsement by the National Marine Fisheries Service, NOAA.

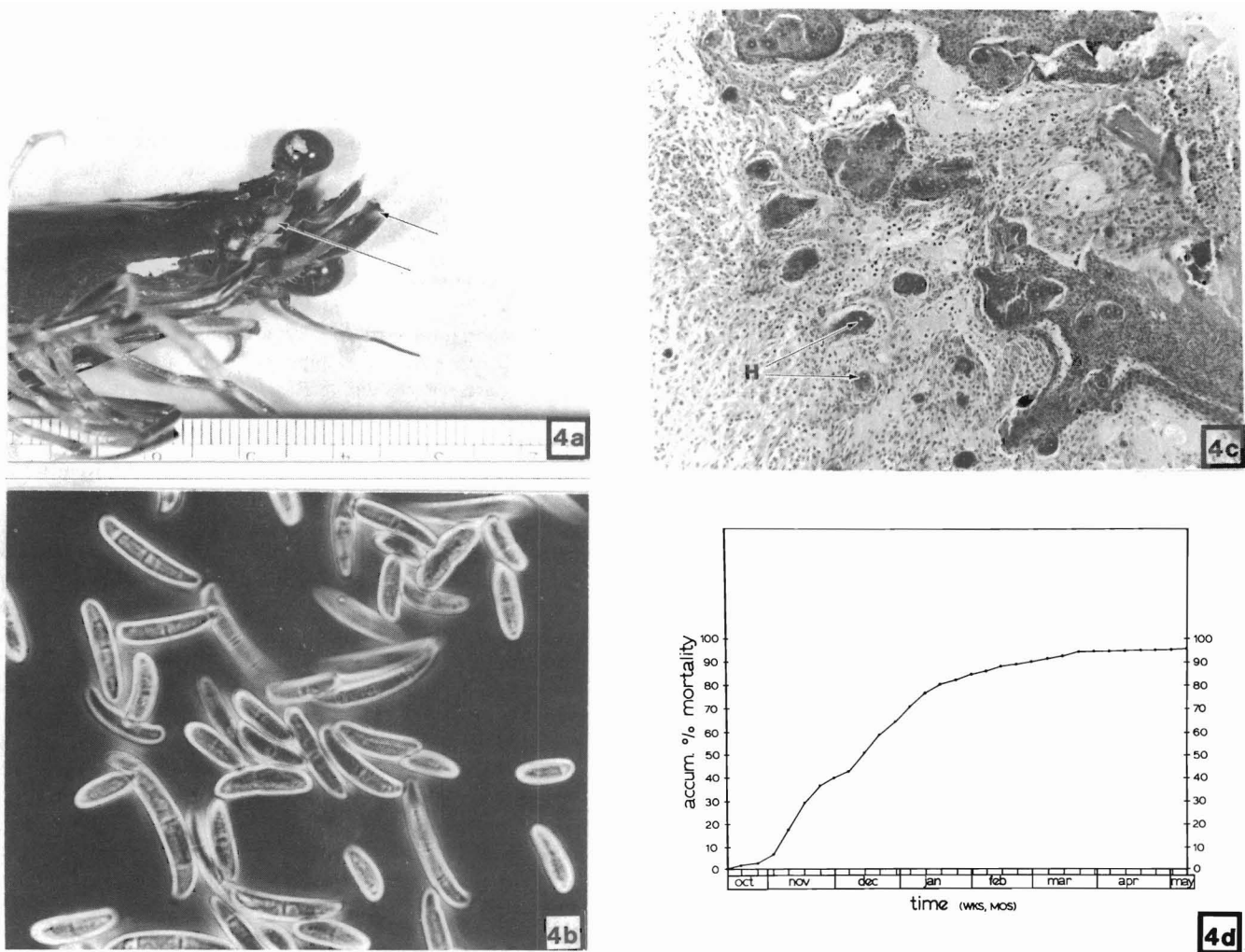

Figure 4.—a. California brown shrimp, *Penaeus californiensis*, with lesions due to *Fusarium solani* on its head appendages (arrows). Only *Fusarium*-infected stumps remain of the antennae, the antennules, and the antennal scales. b. Phase contrast photomicrograph of micro- (the short elliptical one- or two-celled spores) and macroconidia (the longer boat-shaped multicelled spores) of *Fusarium solani*. The presence of these spores in material scraped from suspect lesions is pathognomonic for infection due to *F. solani*. No stain. x 665. c. Photomicrograph through a *Fusarium solani*-caused cuticular lesion on a *Penaeus californiensis*. Present in the proximal portion of the lesion (left) are degenerating muscle fibers. Centrally and distally in the lesion are masses of infiltrating hemocytes, some of which have encapsulated hyphae (H) of *F. solani*. Masses of necrotic and melanized hemocytes are represented as darkened areas. Hematoxylin and eosin. x 93. d. Plots of time versus accumulated mortality in an epizootic in a raceway population of California brown shrimp, *Penaeus californiensis*.

Table 2.—Susceptibility and incidence of *Fusarium solani* infections in three species of *Penaeus* at Puerto Peñasco.

Species	Relative susceptibility	Earliest susceptible age (wk)	Incidence ¹
<i>Penaeus californiensis</i> (Calif. brown)	high	30-40	255
<i>P. stylirostris</i> (Blue)	moderate	40-50	36.5
<i>P. vannamei</i> (White)	low	68	43.5

¹Incidence per thousand of population for time period January to March 1977.

²Born 4/2/76.

³Born 5/1/76.

⁴Born 9/4/75.

at various locations in the shrimp. To date, black death has been experimentally induced in *P. californiensis* and *P. stylirostris* by feeding diets devoid of added ascorbic acid (Magarelli et al. 1979; Lightner, Hunter, Magarelli, and Colvin 1979). Deshimaru and Kuroki (1976) have probably observed the same syndrome in *P. japonicus*.

Histologically, black death lesions may be distinguished from shell disease lesions, which they superficially resemble, by the lack of erosion or damage to the cuticle in the former disease (Fig. 5b). Instead, black death lesions are melanized, hemocytic lesions present in the epithelial and subepithelial connective tissues of the stomach, hindgut, gill, and general cuticle, and in the loose connective tissues in such organs as the hepatopancreas, the nerve cord, etc. (Lightner, Hunter, Magarelli, and Colvin 1979; Hunter et al. 1979).

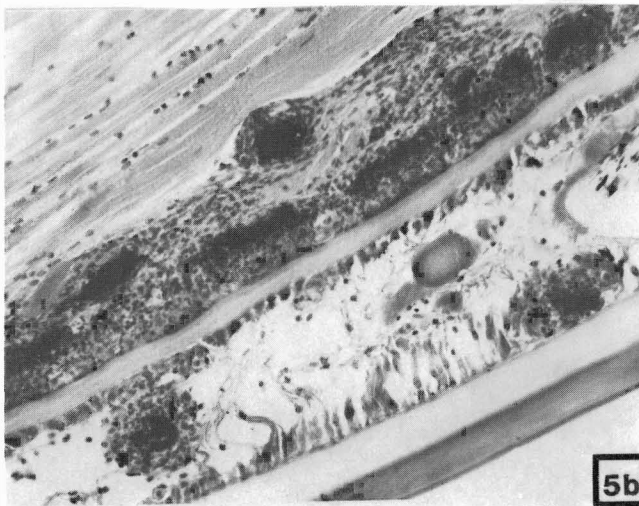
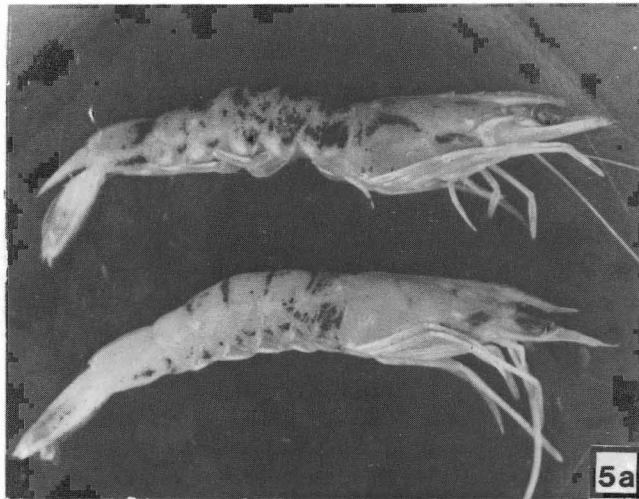

Figure 5.—a. Gross photograph of juvenile California brown shrimp, *Penaeus californiensis*, with the disease black death, which is due to a dietary deficiency of ascorbic acid. b. Photomicrograph of a section through one of the blackened cuticular lesions like those shown in Fig. 5a. This section was made through the junction of two adjacent abdominal pleural plates, hence two sections of cuticle are present. Melanized accumulations of hemocytes are present in the hypodermis and especially in the subhypodermal connective tissues. Hematoxylin and eosin. x 170.

Bacterial Diseases

Diseases due to bacterial infections in captive wild and in cultured shrimp are well known (Lewis 1973a, b; Cook and Lofton 1973; Delves-Broughton and Poupard 1976; Lightner and Lewis 1975; Aquacop 1977; Lightner 1977). In every reported case of bacterial infections in penaeid shrimp, motile gram-negative, oxidase positive, fermentative rods have been isolated. So far, most isolates have been *Vibrio alginolyticus*, *V. parahaemolyticus*, or *V. anguillarum*. Certain other species of *Vibrio*, *Pseudomonas*, and *Aeromonas* may occasionally be involved in this disease syndrome (Lewis 1973b; Lightner 1977).

Bacterial infections in shrimp may take two forms, localized pits in the cuticle (shell disease) or generalized septicemias. In shell disease (Cook and Lofton 1973), the causative organisms cause erosions of the cuticle. However, if such lesions are not suc-

cessfully resolved by the host's inflammatory response, septicemia and death will result. In CEAg of penaeid shrimp, most bacterial diseases seem to be of a secondary nature, resulting from some primary lesion due to another infectious organism, a parasite, to wounds, or to nutritional, mechanical, chemical, or physical stress (Lightner 1977).

Diagnosis of bacterial infections is made by the demonstration of gram-negative motile rods in the hemolymph or tissues of shrimp with advanced shell disease or with septicemias. Successful therapy of bacterial infections in penaeid shrimp (Table 1) has been reported by the direct addition of certain antibiotics to the culture tank water (Aquacop 1977; Delves-Broughton and Poupard 1976) which is practical only in shrimp hatching, larval-rearing, and nursery tanks, or by the use of medicated feeds (Table 1) in larger shrimp.

Larval Mycosis

The phycomycetous fungus *Lagenidium callinectes* has been observed and has caused significant epizootics in the larval stages of *P. stylirostris* and *P. californiensis* at Puerto Peñasco. Losses approaching 100% (Fig. 6) have been observed in our Galveston-style larval-rearing tanks (Lightner 1976; Salser et al. 1978). In these larval-rearing tanks, *L. callinectes* has been observed to infect fertilized and unfertilized eggs, all of the larval stages, and up to 2-d-old postlarvae. The naupliar and early protozoal stages are those stages that are typically the most severely affected.

The source of the fungus infecting larval shrimp in larval-rearing tanks has been shown to be the gravid female shrimp from which the spawn was obtained. *Lagenidium callinectes* is apparently a normal epiphytic saprophyte on adult wild and hatchery-reared penaeid shrimp. An infection is established when a zoospore attaches to, and encysts upon, the cuticle of an egg or larval shrimp. The encysted spore then germinates, with the germ tube penetrating the cuticle. The mycelium gradually expands and appears to replace most of the striated-muscle tissues until the larva is literally filled with hyphae. Infected individuals become immobile and settle to the bottom of the tank. Sporogenesis then begins with formation of discharge tubes, terminal vesicles, and release of zoospores (Lightner and Fontaine 1973).

Several methods of chemotherapy for *Lagenidium* have been reported (Armstrong et al. 1976; Bland et al. 1976; Aquacop 1977), and two chemicals have shown promise in controlling the fungus. Bland et al. (1976) and Lightner (1977) reported malachite green oxylate at 0.006 ppm (static) as effective in arresting *Lagenidium* epizootics in larval rearing tanks or in preventing epizootics, if added prior to the time the epizootics become established (Fig. 6). Armstrong et al. (1976) and Aquacop (1977) found trifuralin (Treflan) to be effective in preventing *Lagenidium* epizootics in the culture of larval crabs and shrimp. For *Lagenidium* control in shrimp, Aquacop (1977) found that a single application of 0.01 ppm Treflan was enough to kill *Lagenidium* zoospores, but such applications had no effect on the thalli which continued to grow and reproduce. Aquacop (1977) further reported that multiple 6-h duration applications of Treflan in the parts-per-billion range are effective in preventing the disease.

Blue-Green Algae Poisoning (Hemocytic Enteritis)

Blooms of certain marine filamentous blue-green algae, all belonging to the family Oscillatoriaceae have been implicated as

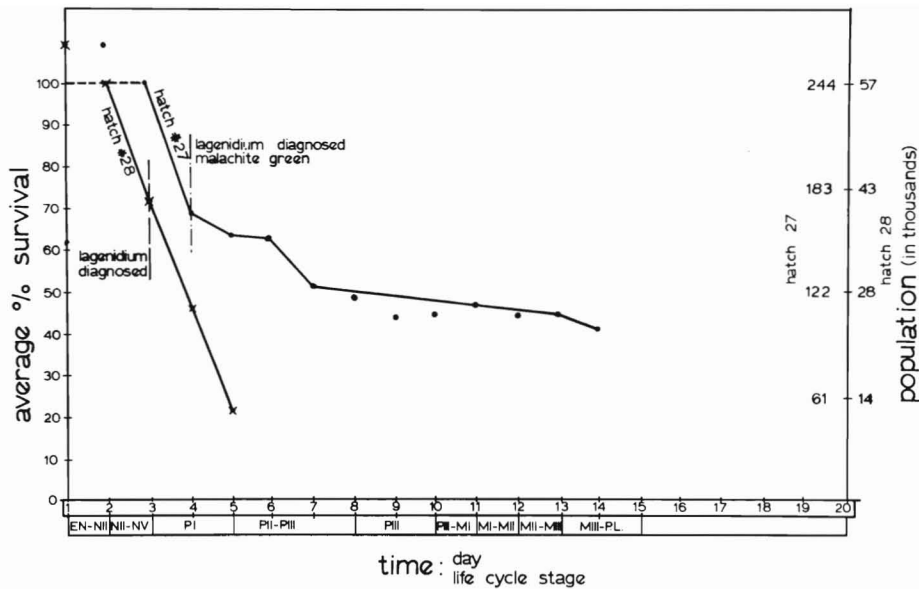

Figure 6.—Survival plots of larval blue shrimp, *Penaeus stylirostris*, populations in which disease due to *Lagenidium callinectes* was epizootic. The population designated as “hatch 27” was treated with malachite green upon detection of the presence of *Lagenidium*, while the population labeled “hatch 28” was not. The epizootic in hatch 27 was arrested with nearly a 50% survival rate, while the untreated hatch 28 had nearly 100% mortality.

causative agents in a disease syndrome of primarily young juvenile *P. stylirostris* of 0.1 to 5 g average weight. However, the disease has been observed in 12 to 20 g *P. stylirostris*. The disease, called hemocytic enteritis (HE), apparently results from the effect of toxins released in the gut from ingested algae (Lightner 1978a; Lightner et al. 1978). The principal lesion observed in this disease is necrosis and hemocytic inflammation of the mucosa (Fig. 7) of those portions of the shrimp gastrointestinal tract that lack a chitinous lining (the midgut, the epigastric caecum, and the hindgut caecum).

The cause of death in shrimp with HE may be due to osmotic imbalances or to poor absorption of nutrients from the midgut due to the destruction of the midgut mucosa but, in most instances, death appears to be due to secondary bacterial septicemias. *Vibrio* sp., principally *V. alginolyticus*, is the organism most commonly isolated from the hemolymph of shrimp with septic HE (Lightner 1978a; Lightner et al. 1978). Mortality rates in populations of *P. stylirostris* with HE have reached 85% but, typically, have been < 50% of the affected population (Table 3).

At Puerto Peñasco, three species of the Oscillatoriaceae, because of their relative abundance in shrimp tanks during HE epizootics, have been suspect as probable causative algae. Of these three species, two (*Schizothrix calcicola* (Agardh) Gamont and *Spirulina subsalsa* Oersted), have been shown to induce the disease experimentally when fed as unialgal cultures to susceptible juvenile *P. stylirostris*. A third species, *Microcoleus lyngbyaceus* (Kützinger) Crouan, while suspected as being a cause of HE in shrimp tanks, has not been shown to induce the disease in experi-

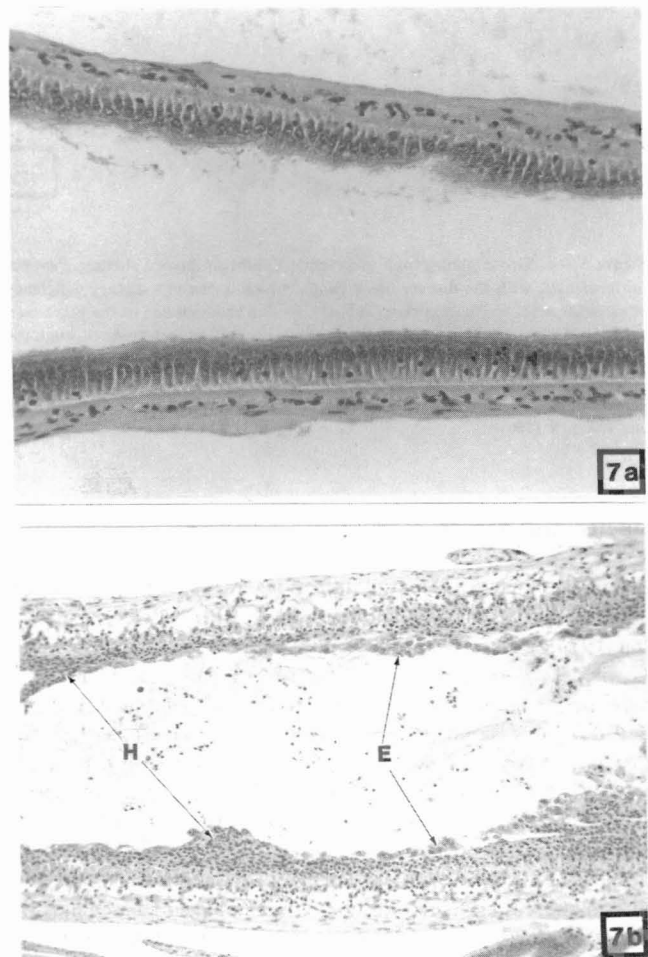

Figure 7.—a. A sagittal section of the normal anterior midgut of a juvenile blue shrimp, *Penaeus stylirostris*. Hematoxylin and eosin. x 186. b. A sagittal section of the anterior midgut of a juvenile blue shrimp with hemocytic enteritis. Remnants of the gut mucosal epithelium (E) are present, but in many areas only masses of hemocytes (H) line the gut lumen. Hematoxylin and eosin. x 83.

Table 3.—Summary of hemocytic enteritis epizootics in blue shrimp, *Penaeus stylirostris*, which occurred during blooms of certain blue-green algae in raceways at Puerto Peñasco.

Approximate dates of epizootic	Tank or raceway no.	Size range wt. (g)	Population		Approximate % loss
			Initial	Final	
July-Sept. 1975	4	0.05-4.0	17,700	2,700	85
July-Aug. 1976	9	0.62-2.4	21,000	4,000	81
Oct.-Dec. 1976	5	0.54-2.6	21,700	8,700	60
Oct. 1976	6	0.24-1.0	19,600	10,500	46
Nov. 1976	11	2.9-5.0	11,200	6,900	38
Jan.-Mar. 1977	12	12.3-19.8	12,700	11,100	13
Oct.-Nov. 1977	7	0.01-0.5	26,000	10,000	61
Apr. 1978	11	0.5	105,000	102,000	3
Mar.-Apr. 1979	P2	0.01-0.5	68,000	60,000	12
May 1979	P1 & 2	0.01-0.1	120,000	—	10-20
July-Aug. 1979	P4 & 5	0.01-0.1	506,000	461,000	10
Sept.-Nov. 1979	P3	0.01-0.1	849,000	497,000	40
Sept.-Nov. 1979	P4 & 5	0.01-0.6	563,000	486,000	15
Nov. 1979	P1 & 2	0.1-0.5	450,000	358,000	20
Feb. 1980	G7	0.1-2.1	208,000	197,000	5
Feb. 1980	G8	0.5-1.0	123,000	121,000	2
Apr. 1980	P1	0.01-0.5	310,000	250,000	20
Apr. 1980	G10,11,12	1.0-1.5	275,000	—	5

ments in which unialgal cultures were fed to susceptible *P. stylirostris*.

Because HE typically has a septic phase that is the usual cause of death, antibiotic therapy is often useful. Medicated feeds containing Terramycin (oxytetracycline hydrochloride) and/or Furacin (nitrofurazone) have been used with mixed success in reducing mortality rates due to HE at Puerto Peñasco (Lightner et al. 1978). The use of algaecides also appears promising in preventing this disease by reducing the amount of blue-green algae present in shrimp rearing tanks.

Blue Syndrome X

Since the shrimp project was started at Puerto Peñasco, a peculiar disease syndrome, that we call blue syndrome X (BSX), has occurred twice. On both occasions, BSX caused extremely heavy mortalities of juvenile and subadult shrimp. The disease was named blue syndrome X because it was first recognized as a distinct (but of unknown etiology) disease syndrome in populations of the blue shrimp, *P. stylirostris* (Salser et al. 1978). However, the disease is not confined to the blue shrimp, and it is thought to also have occurred in the California brown shrimp, *P. californiensis*, at Puerto Peñasco.

BSX is a difficult disease to diagnose because no consistent, distinctive, or unique lesions are present grossly or histologically. However, blue shrimp populations in which BSX is enzootic do show some characteristic behavior patterns and occasional physical changes that are characteristic of this disease. The first characteristic of BSX is that shrimp, within a population having BSX, die during molting or following handling stress. Secondly, up to 50% of the shrimp within BSX affected populations have been observed to develop "blunted heads" (Fig. 8) within a few weeks after BSX mortalities have begun in the affected population. This erosion of the head appendages is apparently due to abnormal trauma to those appendages by repeated collisions with the walls of the culture tank, or to poor calcification of the new exoskeleton in those regions.



Figure 8.—Photograph of subadult blue shrimp, *Penaeus stylirostris*. The bottom shrimp has normal head appendages, while the two above have "blunted" or eroded away the antennae, antennules, rostrum, antennal blades, and portions of their compound eyes. Such erosions of the head appendages are typical of shrimp having blue syndrome X (BSX) disease.

The etiology of BSX is uncertain,⁴ but circumstantial evidence suggests that the most recent occurrence of BSX at Puerto Peñasco was due to a batch of cod-liver oil (which is included in the shrimp's ration to supply essential fatty acids and certain vitamins) that was contaminated with up to 25 ppm PCB and up to 5 ppm DDT and DDE. However, we have not yet proven the relationship of these contaminants to BSX disease.

⁴Tests run subsequently to submission of this manuscript indicated that the suspect cod liver oil when added to the shrimp ration at 0, 1×, and 4× of the normal levels had no effect on the prevalence of BSX, nor on tissue levels of accumulated PCB, DDT, and DDE in affected populations of blue shrimp. Hence, the etiology of BSX remains unproven.

Baculovirus Disease

A single population of adult *Penaeus monodon* was annihilated by a disease called MBVD (monodon baculovirus disease). Adult and subadult *P. stylirostris* and *P. californiensis* directly exposed to MBV-infected *P. monodon* for several months were apparently resistant to infection by the virus and showed no mortalities or other signs of the disease.

In *P. monodon*, MBVD is diagnosed by demonstration of multiple nuclear polyhedral bodies (Fig. 9) within the hypertrophied nuclei of infected hepatopancreatic epithelial cells (Lightner and Redman 1981).

Virus particles, occurring both free in the nucleoplasm or occluded within the inclusion bodies, displayed a morphology typical of baculovirus occurring in other Arthropods and in other species of penaeid shrimp (Summers 1977; Couch 1974).

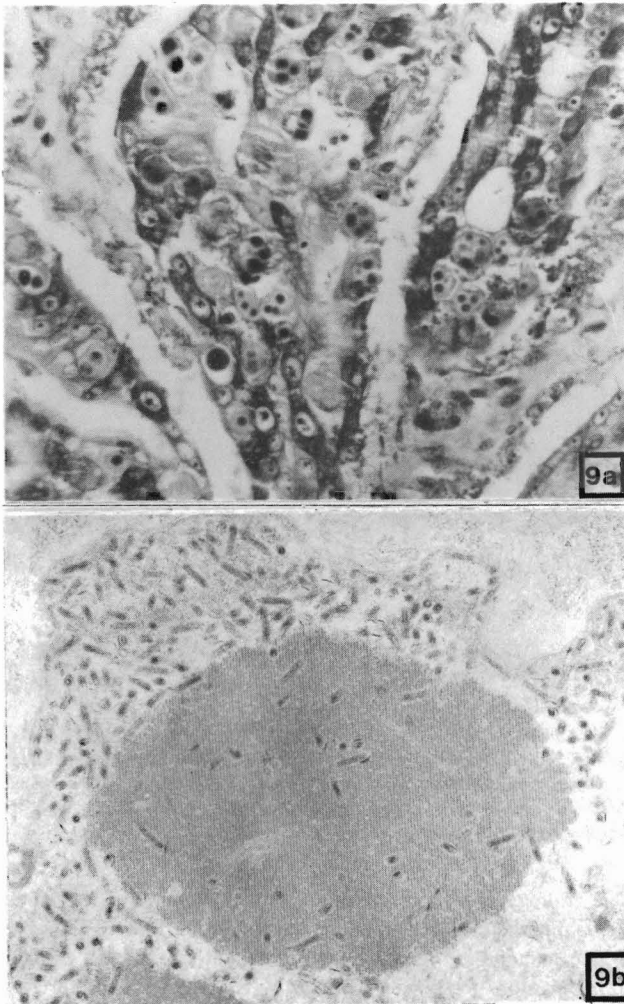

Figure 9.—a. Photomicrograph of a section of the hepatopancreas of a *Penaeus monodon* with monodon baculovirus disease (MBVD). The nuclei of many hepatopancreatic epithelial cells are greatly hypertrophied and contain from one to several rounded inclusion bodies. Wolback's giemsa. $\times 379$. b. Electron micrograph of a hepatopancreatic epithelial cell that is infected with MBV. Numerous rod-shaped virions are present free in the karyoplasm and occluded within the large spherical crystalline inclusion body. Lead citrate and uranyl acetate. $\times 16,226$.

Death in shrimp with MBVD may be due to destruction of the hepatopancreatic tubule epithelium or to secondary bacterial septicemias (usually due to *V. alginolyticus*). Because of the secondary bacterial septicemias, antibiotic therapy was useful in delaying, but not stopping, mortalities due to MBVD in the population of *P. monodon*.

LITERATURE CITED

- AQUACOP.
1977. Observations on diseases of crustacean cultures in Polynesia. Proc. World Maricult. Soc. 8:685-703.
- ARMSTRONG, D. A., D. V. BUCHANAN, and R. S. CALDWELL.
1976. A mycosis caused by *Lagenidium* sp. in laboratory-reared larvae of the dungeness crab, *Cancer magister*, and possible chemical treatments. J. Invertebr. Pathol. 28:329-336.
- BLAND, C. E., D. G. RUCH, B. R. SALSER, and D. V. LIGHTNER.
1976. Chemical control of *Lagenidium*, a fungal pathogen of marine crustacea. Univ. N. Carolina Sea Grant Program, Publ. No. UNC-SG-76-02, 38 p.
- BROCK, T. D.
1974. Family IV. Leucotrichaceae Buchanan 1957. In R. E. Buchanan and N. E. Gibbons (editors), *Bergey's manual of determinative bacteriology*. 8th ed., p. 118-119. The Williams & Wilkins Co., Baltimore, Md.
- COOK, D. W., and S. R. LOFTON.
1973. Chitinoclastic bacteria associated with shell disease in *Penaeus* shrimp and the blue crab (*Callinectes sapidus*). J. Wildl. Dis. 9:154-159.
- COUCH, J. A.
1974. An enzootic nuclear polyhedrosis virus of pink shrimp: Ultrastructure, prevalence, and enhancement. J. Invertebr. Pathol. 24:311-331.
1978. Diseases, parasites, and toxic responses of commercial penaeid shrimps of the Gulf of Mexico and South Atlantic coasts of North America. Fish. Bull., U.S. 76:1-44.
- DELVES-BROUGHTON, J., and C. W. POUPARD.
1976. Disease problems of prawns in recirculation systems in the U.K. Aquaculture 7:201-217.
- DESHIMARU, O., and K. KUROKI.
1976. Studies on a purified diet for prawn—VII. Adequate dietary levels of ascorbic acid and inositol. Bull. Jpn. Soc. Sci. Fish. 42:571-576.
- EGUSA, S., and T. UEDA.
1972. A *Fusarium* sp. associated with black gill disease of the Kuruma prawn, *Penaeus japonicus* Bate. Bull. Jpn. Soc. Sci. Fish. 38:1253-1260.
- HATAI, K., K. NAKAJIMA, and S. EGUSA.
1974. Effects of various fungicides on the black gill disease of the Kuruma prawn *Penaeus japonicus* caused by *Fusarium* sp. Fish Pathol. 8:156-160.
- HUNTER, B., P. C. MAGARELLI, Jr., D. V. LIGHTNER, and L. B. COLVIN.
1979. Ascorbic acid-dependent collagen formation in penaeid shrimp. Comp. Biochem. Physiol. 64B:381-385.
- JOHNSON, S. K., J. C. PARKER, and H. W. HOLCOMB.
1974. Control of *Zoothamnium* sp. on penaeid shrimp. Proc. World Maricult. Soc. 4:321-331.
- LEWIS, D. H.
1973a. Predominant aerobic bacteria of fish and shellfish. Tex. A&M Univ., Sea Grant Publ. 401, 102 p.
1973b. Response of brown shrimp to infection with *Vibrio* sp. Proc. World Maricult. Soc. 4:333-338.
- LIGHTNER, D. V.
1975. Some potentially serious disease problems in the culture of penaeid shrimp in North America. Proc. U.S.-Japan Natural Resources Program, Symposium of Aquaculture Disease, Tokyo, p. 75-97. Spec. Publ. Fish. Agency, Jpn. Govt. and Jpn. Sea Reg. Fish. Res. Lab., Niigata.
1976. Epizootiology of two mycotic diseases in the culture of penaeid shrimp. Proceedings of the First International Colloquium on Invertebrate Pathology and 9th Annual Meeting of the Society for Invertebrate Pathology, p. 179-183. Queens Univ. Kingston, Ontario, Canada.
1977. Shrimp diseases. In C. J. Sindermann (editor), *Disease diagnosis and control in North American marine aquaculture*. Developments in aquaculture and fisheries science, Vol. 6, p. 10-77. Elsevier Sci. Publ. Co., N.Y.
1978a. Possible toxic effects of the marine blue-green alga, *Spirulina subsalsa*, on the blue shrimp, *Penaeus stylirostris*. J. Invertebr. Pathol. 32:139-150.
1978b. Gill disease; a disease of wild and cultured penaeid shrimp. Proc. 66th Meeting International Council for the Exploration of the Sea. C.M. 1978/F:24.
- LIGHTNER, D. V., L. B. COLVIN, C. BRAND, and D. A. DANALD.
1977. Black Death, a disease syndrome of penaeid shrimp related to a dietary deficiency of ascorbic acid. Proc. World Maricult. Soc. 8:611-623.

- LIGHTNER, D. V., D. A. DANALD, R. M. REDMAN, C. BRAND, B. R. SALSER, and J. REPRIETA.
1978. Suspected blue-green algal poisoning in the blue shrimp. Proc. World Maricult. Soc. 9:447-458.
- LIGHTNER, D. V., and C. T. FONTAINE.
1973. A new fungus disease of the white shrimp *Penaeus setiferus*. J. Invertebr. Pathol. 22:94-99.
- LIGHTNER, D. V., C. T. FONTAINE, and K. HANKS.
1975. Some forms of gill disease in penaeid shrimp. Proc. World Maricult. Soc. 6:347-365.
- LIGHTNER, D. V., B. HUNTER, P. C. MAGARELLI, Jr., and L. B. COLVIN.
1979. Ascorbic acid: nutritional requirement and role in wound repair in penaeid shrimp. Proc. World Maricult. Soc. 10:513-528.
- LIGHTNER, D. V., and D. H. LEWIS.
1975. A septicemic bacterial disease syndrome of penaeid shrimp. Mar. Fish. Rev. 37(5-6):25-28.
- LIGHTNER, D. V., D. MOORE, and D. A. DANALD.
1979. A mycotic disease of cultured penaeid shrimp caused by the fungus *Fusarium solani*. In D. H. Lewis and J. K. Leong (editors), Proc. Second Biennial Crustacean Health Workshop. Texas A&M Univ. TAMU-SG-79 114:137-158.
- LIGHTNER, D. V., and R. M. REDMAN.
1981. A baculovirus-caused disease of the penaeid shrimp, *Penaeus monodon*. J. Invertebr. Pathol. 38:299-302.
- LIGHTNER, D. V., and V. C. SUPPLEE.
1976. A possible chemical control method for filamentous gill disease. Proc. World Maricult. Soc. 7:473-481.
- MAGARELLI, P. C., Jr., B. HUNTER, D. V. LIGHTNER, and L. B. COLVIN.
1979. Black death: an ascorbic acid deficiency disease in penaeid shrimp. Comp. Biochem. Physiol. 63A:103-108.
- MOCK, C. R., and M. A. MURPHY.
1970. Techniques for raising penaeid shrimp from the egg to post-larvae. Proc. World Maricult. Soc. 1:143-156.
- MOCK, C. R., D. B. REVERA, and C. T. FONTAINE.
1980. Preliminary observations on the larval culture of *Penaeus stylirostris* using modifications of the Galveston technique. Proc. World Maricult. Soc. 11:102-117.
- OVERSTREET, R. M.
1973. Parasites of some penaeid shrimps with emphasis on reared hosts. Aquaculture 2:105-140.
- SALSER, B., L. MAHLER, D. LIGHTNER, J. URE, D. DANALD, C. BRAND, N. STAMP, D. MOORE, and B. COLVIN.
1978. Controlled environment aquaculture of penaeids. In P. N. Kaul and C. J. Sindermann (editors), Drugs and food from the sea, myth or reality?, p. 345-355. Univ. Oklahoma Press, Norman.
- SCHNICK, R. A., F. P. MEYER, L. L. MARKING, T. D. BILLS, and J. H. CHANDLER, Jr.
1979. Candidate chemicals for crustacean culture. In D. Lewis and J. Leong (editors), Proc. Second Biennial Crustacean Health Workshop. Texas A&M Univ. TAMU-SG-79 114:245-294.
- SIEBURTH, J. M.
1975. Microbial seascapes. A pictorial essay on marine microorganisms and their environments. Univ. Park Press, Baltimore, Md., 247 p.
- SUMMERS, M. D.
1977. Baculoviruses (Baculoviridae). Chapter 1. In K. Maramorosch (editor), The atlas of insect and plant viruses. Ultrastructure in biological systems, Vol. 8, p. 3-27. Acad. Press, N.Y.



Research and Development in Freshwater Prawn, *Macrobrachium rosenbergii*, Culture in the United States: Current Status and Biological Constraints With Emphasis on Breeding and Domestication

SPENCER MALECHA¹

INTRODUCTION

In this paper I would like to briefly review the research and development (R & D) of prawn culture in the United States, including its current status in Hawaii, and mention some of the current developments which show promise. I will then discuss a few major biological properties of the prawn or its culture system which, in my view, presently constrain optimal production. I will end my paper with a review of some of the results I have obtained in my breeding and domestication work and will point out what I feel to be promising areas of future R & D.

The state of the art of *Macrobrachium rosenbergii* culture has been reviewed elsewhere (Hanson and Goodwin 1977; Ling and Costello 1976). In addition, the *Proceedings of the World Mariculture Society*, from 1975 to the present, and the journal *Aquaculture*, from 1970 to the present, contain most of the papers that have been published regarding *M. rosenbergii* research. It is not my intent to provide a comprehensive review of all this work but only to point out what I feel are the highlights in prawn R & D in the United States. For greater accuracy in technical data the reader is referred to the professional published literature.

LIFE CYCLE

Macrobrachium rosenbergii is a large² freshwater decapod caridean crustacean distributed throughout areas of Southeast Asia, India, Australia, and areas around the South China Sea (see Fig. 13). Reviews of its biology can be found in Ling (1969a), Miyajima (1977), and Wickins (1976). The genus *Macrobrachium* contains hundreds of species which have been monographed for Southeast Asia (Holthuis 1950) and the Americas (Holthuis 1952). *Macrobrachium rosenbergii* apparently is a species that is evolving "out of the sea" (Johnson 1960a) in that its larvae require brackish water for their development. In fact, the "break through" in closing the life cycle of *M. rosenbergii* came when Ling (1969b) raised the salinity in his larval culture aquaria to 16‰ (Goodwin 1977). Previous attempts to rear larvae to metamorphosis failed because only freshwater was used.

There are constraints in prawn aquaculture (see later) but these do not involve life cycle factors. The various stages in the prawn's

life cycle, including maturation, courtship, mating, brooding, spawning, larval development, and juvenile to adult growth, may be accomplished in tanks, ponds, or aquaria.

Figure 1 shows the overall life cycle of the prawn. Breeding behavior has been described by Rao (1965) and Ling (1969a). Mating occurs between hard-shelled males and newly molted females. Adults form single pair bonds and undergo amplexus at which time a spermatophore (sperm packet) is deposited on the female's abdomen (Sandifer and Smith 1979; Sandifer and Lynn 1980). Eggs, extruded through the female's gonopores, pass through this packet, are fertilized, and remain attached to the female's ventral abdomen ("tail") during incubation. This lasts for about 15 d after which free swimming protozoa larvae are released ("hatched") into the water column. These undergo 11 larval stages followed by one molt into benthic crawling postlarvae (PL). Since there is considerable variation in individual growth which leads to a size frequency distribution with a large variance, growth

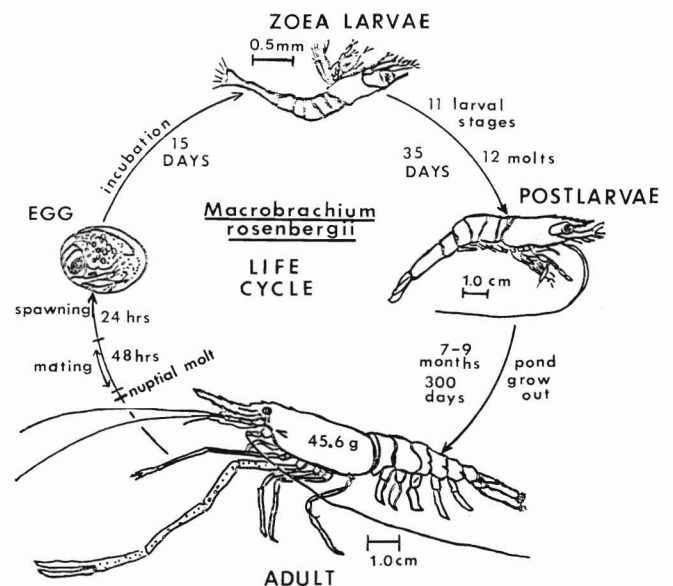

Figure 1.—Life cycle of the freshwater prawn, *Macrobrachium rosenbergii*. Figures represent average values for stages in Hawaii. Larval and pond growout stages can vary considerably in individual circumstances depending upon environmental conditions. Adult prawn drawn to represent a 45.6 g individual (10/lb, 22/kg), an average market weight. Mating, including amplexus, is of variable length over a 48-h period during which the female is receptive. Spawning usually occurs within 24 h of successful mating.

¹Prawn Aquaculture Research Program, Department of Animal Sciences, University of Hawaii, Honolulu, HI 96844.

²My field studies have measured a 654 g male in New Guinea. Reports of a 1,000 g animal come from Taiwan.

to sexual maturity is variable (6-9 mo) and harvestable (> 35 g) prawns are available in 9-11 mo.

EXPERIMENTAL RESEARCH

Naturally, the growing interest in freshwater prawn culture has generated experimental research efforts designed to answer some of the fundamental questions which could lead to better production. By experimental research we mean research conducted where there is some degree of control over variables whose effects are under study and also where controls and replications of treatments are possible. This is in contrast to research in new technology development where efforts are made to achieve a certain result and not necessarily to understand the underlying causes of these results or the relationship of the variables which affect the outcome.

A number of groups around the United States have concentrated on research into the different aspects of prawn culture and biology. Table 1 provides a list of these and Figure 2 shows the areas in the United States where the activities are located. This expands the list given in Hanson and Goodwin (1977) but is not meant to be exhaustive. Figure 3 shows the number of research papers that have appeared in the journal *Aquaculture* and in the *Proceedings of the World Mariculture Society*.

Like most of the other aquaculture organisms, the freshwater prawn is relatively biologically unexplored. Consequently, almost anything we learn from using it in experimental research could have impact on optimizing its culture. However, almost all of the research projects listed in Table 1 are applied, i.e., directed toward the prawn's aquaculture potential.

RESEARCH AND DEVELOPMENT PROGRAMS IN THE UNITED STATES

The modern history of the culture of the freshwater prawn, *Macrobrachium rosenbergii*, is short although the prawn has been cultured for centuries in ponds using captured seedstock (Bardach et al. 1972; Ling 1969a). It was not until recently that Ling (1969b) succeeded in closing its life cycle. This was followed by the development, in the late 1960's in Hawaii, of mass rearing techniques by Fujimura and his colleagues who also began the development of pond rearing techniques (Fujimura and Okamoto 1970). The first successful commercial pond, built exclusively for prawns stocked from hatchery reared seed-stock, was started in the early 1970's in Hawaii and is still in production.

Following the successes of Fujimura in developing mass larval rearing and pond culture techniques, Hawaii became the initial leader in the culture of the freshwater prawn. Several agencies in

Table 1.—Research programs in universities and government agencies in the United States.

Organization	Address	Principal contact	Research activities
Universities			
Texas A&M U.	Dep. Wildlife & Fisheries Sci. College Station, TX 77843	Robert Brick	Polyculture, nutritional physiology
U. of Miami	School of Marine & Atmospheric Science 4600 Rickenbacker Causeway Miami, FL 33149	Peter Lutz	Metabolism, stress physiology
Florida Atlantic U.	Boca Raton, FL 33431	Sheldon Dobkin	Pond culture
Clemson U.	Clemson, SC 29631	Larry Bauer	Pond production economics ¹
Rutgers U.	Dep. Physiology P.O. Box 231 New Brunswick, NJ 08903	A. Farmafarmian	Nutrition binders, physiology
U. of Nevada, Reno	School of Veterinary Medicine 5305 Mill Street Reno, NV 89501	Robert Taylor	Hatchery, thermal effluent pond culture, geothermal
Oregon Inst. Technology	OreTech Post Office Klamath Falls, OR 96701	William Johnson	Hatchery, geothermal pond culture
Louisiana State	School of Forestry & Wildlife Management Baton Rouge, LA 70802	Robert Avault	Pond culture, polyculture ¹
Southern U.	Dep. Biol. Sciences Baton Rouge, LA 70813	Jay Huner	Pond culture, polyculture ¹
U. of Hawaii Honolulu, HI 96822	Dep. Animal Sciences	Spencer Malecha	Domestication, breeding, growth biology, polyculture ¹
	Dep. Oceanography	Edward Laws	Pond ecology
	Dep. Agric. Engineering	J. K. Wang	Nursery systems
Government Agencies			
Illinois Natural History Survey	Kinmundy, IL 62854	Homer Buck	Polyculture with manure ¹
National Marine Fisheries Service	Charleston Laboratory P.O. Box 12607 Charleston, SC 29412	L. V. Sick	Nutritional requirements
Marine Resources Research Inst.	South Carolina Wildlife & Marine Res. Dep. P.O. Box 12559 Charleston, SC 29412	Paul Sandifer T. I. J. Smith	Pond culture, ¹ nursery systems, economics, reproductive biology
Anuenue Fisheries Research Center	Area 4, Sand Island Honolulu, HI 96819	Michael Fujimoto	Extension, hatchery

¹Cooperative programs.

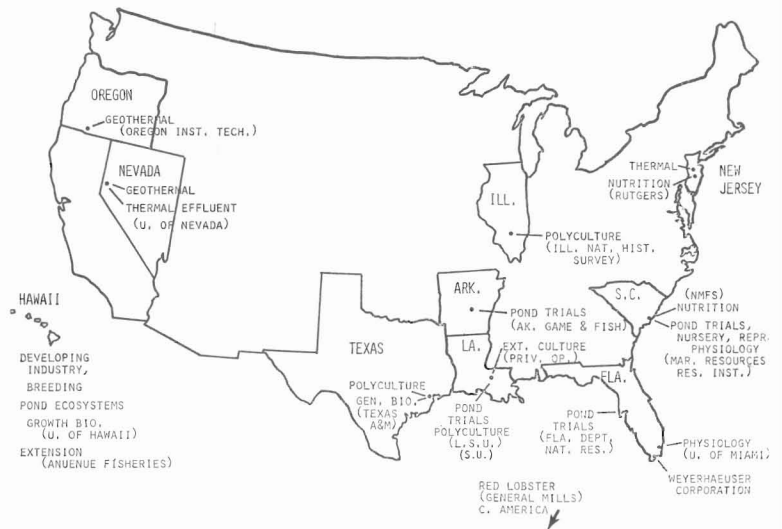

Figure 2.—Locations for prawn R & D activities in the United States, 1980.

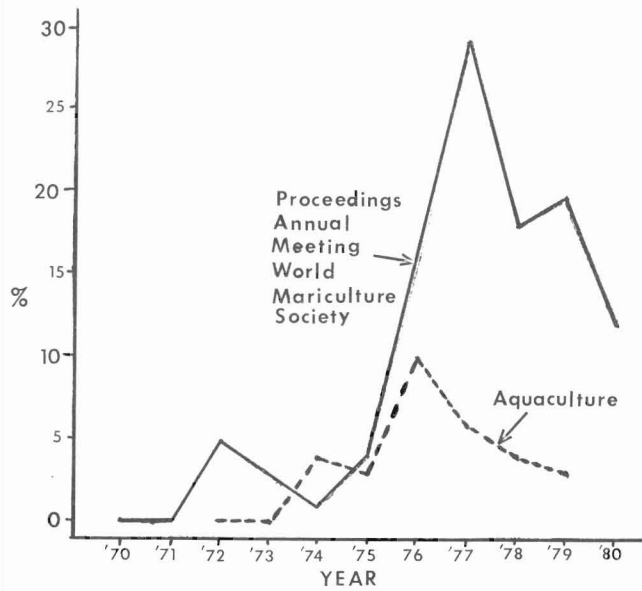

Figure 3.—Percent total papers devoted to research on *Macrobrachium rosenbergii* that have appeared in the journal *Aquaculture* and the *Proceedings of the World Mariculture Society*, 1970-80.

other states soon began R & D programs. South Carolina became a leader in this regard as researchers began the preliminary hatchery and field trials needed to establish the feasibility of growing the freshwater prawn in temperate North America (Sandifer and Smith 1978; Smith and Sandifer 1980; Smith et al. 1977, 1978). The basic constraint to profitable culture seems to be the short growing season which requires a separate nursery phase (Fig. 4; Sandifer and Smith 1978). The great variability in individual growth is also a constraint because it leads to populations with highly skewed size frequency distributions with large variance (Smith et al. 1978) necessitating markets for many size classes. The production economics for pond culture in South Carolina have been completed (Roberts and Bauer 1978) and feed remains the highest fixed cost.

Field trials in 1978 (Smith and Sandifer 1980) have indicated that stocking juvenile prawns as a mixed population of PL's and juveniles was better for seasonal production than stocking PL's alone. This is because the large prawns can be marketed whole as a specialty product and the remaining smaller individuals as shrimp tails. Field trials in 1979 (Smith et al. 1981) show an improvement of the gross feed conversion ratio (from 2:1 in previous years to 1.2:1 in 1979). Additionally, the 1979 field trials indicate that a stocking density of 0.4/ft² (4.3/m²) was the most attractive

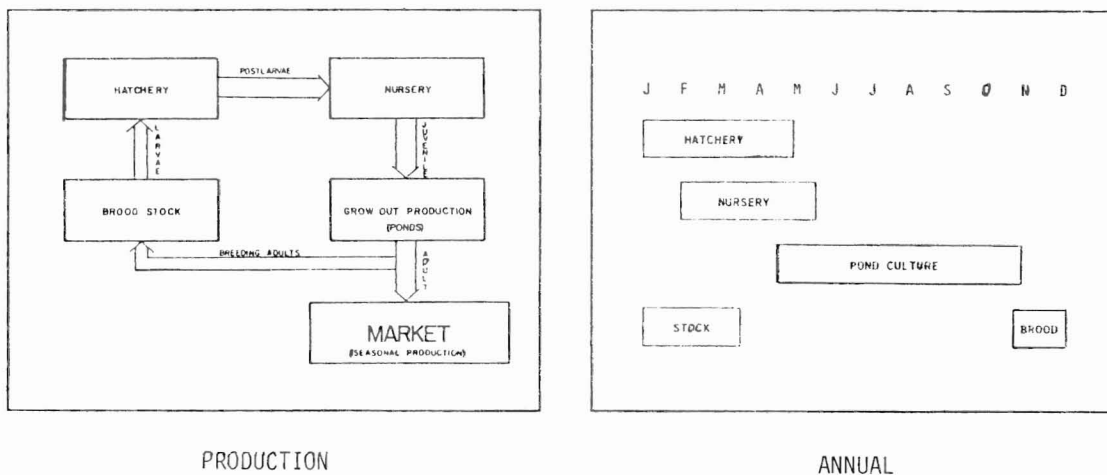

Figure 4.—Production and annual cycles for freshwater prawns in South Carolina (from Sandifer and Smith 1978). The components of these cycles can be considered typical for the continental United States although the duration of each will vary from area to area.

economically, i.e., overall mean size was greater despite lower production; seed costs for this density were lower than the other density.

Research and development activity has also occurred in Florida under the aegis of the Florida Department of Natural Resources. Hatchery (Dugan et al. 1975; Hagood and Willis 1976) and field trials (Willis and Berrigan 1977, 1978) have been completed.

Texas A&M University began a program to study the natural history of native species of *Macrobrachium* in Texas in the early 1970's. From this the present study of practical farm management techniques for *Macrobrachium* production and of their basic biology was begun in 1975.³ Currently, emphasis is placed upon production of *M. rosenbergii* in small ponds (0.1-1.0 ha) although native species are still studied.

The growing season for *M. rosenbergii* in Texas ranges from 4.5 to 6 mo, depending primarily upon latitude. Stocking of ponds usually involves PL's directly from a hatchery. A few private producers have designed warmed nurseries for stocking PL's ahead of the outdoor growing season. These nurseries are indoor, closed systems equipped with biological filters. The first stock of "advanced juveniles" (approximately 2 cm in length) were placed into ponds in 1980.

About a dozen private cooperating farmers are working with Texas A&M's Department of Wildlife and Fisheries this year in their research program across the state. Earthen ponds stocked at a low density (35-40,000/ha) are used for current studies. The ponds are well fertilized and are usually fed sinking catfish pellets as the most readily available feed.

Macrobrachium studies are also supported by the Texas Agricultural Experiment Station. Studies over the last 3 yr have involved polyculture of *M. rosenbergii* with *Tilapia aurea*.

The Texas Agricultural Extension Service is involved in promoting the culture of *M. rosenbergii* in Texas through the networks of County Extension Agents and County Fisheries Extension Agents. Farming freshwater shrimp is promoted as an element of integrated agriculture.

The Arkansas Game and Fish Department⁴ has recently begun pond growth trials with *M. rosenbergii* and has expressed an interest in aiding small-scale commercial development.

From these studies production of between 1,550 and 2,000 kg/ha seems to be possible in one season's growth during the North American summer.

Thermal Effluent and Geothermal

Two recent projects have emphasized the culture of prawns in thermal effluent. A prawn raising project has been underway at the University of Nevada, Reno, since October 1976.⁵ The project has been funded by the Electrical Power Research Institute. The objective of the project is to determine the feasibility of raising prawns in power plant effluent and/or geothermal water in Nevada.

The first year of the project was spent in developing techniques for raising larval prawns to the postlarval stage using Instant Ocean⁶ sea and a recirculating system.

³Robert W. Brick, Department of Wildlife & Fisheries Sciences, Texas A&M University, College Station, TX 77843, pers. commun. 1975.

⁴Mike Freeze, Arkansas Game and Fish Commission, No. 2 Natural Resources Dr., Little Rock, AR 72205, pers. commun.

⁵Robert Taylor, Project Manager, University of Nevada, Reno, Veterinary Medical Center, 5304 Mill Street, Reno, NV 89502, pers. commun. May 1980.

⁶Reference to trade names does not imply endorsement by the National Marine Fisheries Service, NOAA.

During the second year of the project, 264 lb (120 kg) of prawns were produced in a 0.25-acre (0.10 ha) pond at the power plant in a 6-mo growout period during the winter. Cold water temperatures hampered the growth of prawns but results were encouraging enough to expand the project. During the third year, 10 ponds totalling 3 acres (1.21 ha) were operated on a production and research basis.

A 1-acre (0.41 ha) pond was stocked in April 1979 and harvesting was initiated in the pond in mid-September. From mid-September 1979 through mid-January 1980, approximately 1,000 lb (455 kg) of prawns were harvested. Present efforts at the power company are directed at culturing the prawns in floating net structures in the company's main cooling ponds.

The future of prawn raising in Nevada may center around the use of low temperature (< 300°F) geothermal water which will probably be cascaded through a series of uses. Such water is relatively common because of the widespread drilling of geothermal wells which are intended for power production. However, prawn raising in Nevada is still in the pilot stage with no large scale commercial production.

A thermal effluent project has been carried out in New Jersey (Eble et al. 1975, 1977). Although initially promising (Godfriaux et al. 1977), the feasibility of economic culture was deemed slight mainly due to the inability to raise prawns at high densities in small cooling ponds. This points up the importance of the constraint of *Macrobrachium rosenbergii*'s growth pattern, discussed later, to high density culture.

Another project under the lead of the Oregon Institute of Technology⁷ seeks to develop *M. rosenbergii* culture using geothermal water. The initial phase of the program began during the 1975-76 academic year and was primarily concerned with determining the feasibility of rearing *M. rosenbergii* in geothermal waters. Success on a small scale prompted an expansion to a larger operation concerned with an attempt at hatching larvae and rearing them to a reproductive stage in geothermal water. This second phase of the operation also proved to be successful and harvests of a few crops were made of marketable size in less than average time due to the constant water temperature.

The program is in the process of expanding to include two 0.5-acre (0.20 ha) ponds for the purpose of conducting a density and growout period study utilizing different subsurface strata. Also included in the development will be a larger hatchery building which will enable improvement of hatching techniques.

Extensive, Low Input Culture

Inasmuch as *M. rosenbergii* is a benthic omnivore, it is capable of utilizing the natural productivity (microbes, insects, microfauna) from shallow ponds and flood plains. This makes it a good candidate for culture patterned after the extensive "culture" of crawfish in Louisiana and Arkansas.

Small-scale stocking of diked, flooded areas in Louisiana has been tried and has yielded promising results. Production of between 400 and 600 kg/ha seems a reasonable goal. In one trial,⁸ postlarvae were stocked at very low density (2 m²) in early spring, left to survive and grow on the natural productivity that developed in an ecosystem that was dominated by native aquatic macrophytes, and harvested in the fall by slowly draining the area into a catch basin. Total production was 26 kg/ha of tails with only 11%

⁷William Johnson, Project Director, Aquaculture, Oregon Institute of Technology, Klamath Falls, OR 97601, pers. commun. May 1980.

⁸Information provided by J. Boulet, P.O. Box 267, Larose, La.

survival. However, costs of input were very low: Labor at stocking and harvesting, costs of postlarvae, and some pumping costs. Net profit was \$225/acre (¥ 131,216/ha).⁹ This sort of extensive culture seems most promising on marginal areas of land already devoted to other agriculture commodities. If production could be improved to 500 kg/ha, extensive prawn culture could add a value of over \$1,500 (¥ 354,000)/ha to the operation.

As with the other single season crops, there would have to be markets for all the size classes if the large variance in the size frequency distribution develops. The following table shows the various size classes that were marketed in the Boulet trial.

Production (tails)				Selling price		% of total harvested
Lb	kg	No./lb	No./kg	\$US/lb	¥/kg	
285	129.4	15-20	33-44	5.50	2,856	30
530	241.0	24-30	53-66	4.90	2,543	54
50	22.7	36-42	79-92	3.75	1,947	5
30	13.6	43-50	95-110	3.25	1,687	3
60	27.2	51-60	112-132	2.70	1,401	6
20	9.1	> 81	> 178	1.25	649	2

The low stocking density seems to reduce the intrapopulation competition possibly due to the fact that animal to animal encounters may be infrequent. The net result is that a highly skewed depensated population may not develop. Such a population is a major constraint to more intensive culture (see later).

Polyculture

The benthic omnivorous feeding niche which *Macrobrachium rosenbergii* occupies makes it a good candidate for polyculture with fishes, especially with low cost organic inputs like manure. Malecha, Buck, Baur, and Onizuka (1981) have demonstrated the potential of the polyculture of prawns and a complete complement of fishes occupying various feeding niches. They raised pigs along the pond banks to provide manure and obtained good growth, but their prawn production was low (322.3 kg/ha) in their first trial due to the fact that their system was probably understocked (6.2/m²). Nevertheless, these results clearly demonstrate that *M. rosenbergii* can derive a significant, if not complete, portion of its nutritional requirements from heterotrophic productivity stimulated by low cost organic inputs. Moreover, the cost savings from no supplemental prawn feeding complemented by the increased revenue possible from fish and agricultural livestock give polyculture a high potential for use in economical prawn culture.

Other studies have emphasized the use of polyculture in prawn pond culture. Huner et al. (1980) polycultured *M. rosenbergii* with catfish, *Ictalurus punctatus*, fingerlings and obtained 449 kg/ha of prawns. Similarly, Brick and Stickney (1979) have reared *M. rosenbergii* and *Tilapia aurea* in Texas.

INDUSTRY OPERATIONS

Continental United States

To date private operations using extensive pond culture of *Macrobrachium rosenbergii* have not been developed in the United

States on a large scale. From time to time, a small operation will begin but no significant commercial culture is presently being conducted in the continental United States and prawn culture is, by and large, still in the formative stages. Despite this, interest in freshwater prawn culture remains quite high, and two mainland based U.S. companies remain in freshwater prawn aquaculture.

The Weyerhaeuser Corporation maintains a hatchery and R & D facility in Homestead, Fla.¹⁰ (Note added in proof: This company is no longer in business.) Research at this facility is directed in the areas of pond management, population manipulation, and feed formulation. In the area of pond management, the operating assumption is that large pond acreages (as might be expected in future expansion) will have to be self-managing so that "crises of scale" will not develop (more will be said about this later). Weyerhaeuser's efforts in population manipulation involve working on strategies to maximize yield within the existing limitations of the organism. In the area of feed management, means of supplying critical nutritional elements through pond food webs are being investigated.

The other large U.S. company is Red Lobster Inns, with corporate headquarters in the United States¹¹ and a freshwater shrimp farm in Central America.¹² The pond facility is located near San Pedro Sula, Honduras, and consists of 54 ponds (67 acres; 27.13 ha) ranging from 10 acres (14.1 ha) to 3.0 acres (1.21 ha). A coastal hatchery is near Puerto Cortes and consists of 25 4,000-gal (15,160 l) tanks. An inland hatchery at pond site has 3 4,000-gal (15,160 l) and 38,000-gal (144,020 l) tanks. Both hatcheries average 90-140 PL/gal (24-37/l) at 8-9 cycles/yr. R & D efforts concentrate on increasing pond production, nutrition, and feed efficiency. No hatchery R & D is being conducted. Current pond production is averaging 2,500 lb/acre per yr (2,806 kg/ha per yr) with up to 3,500 lb/acre per yr (3,930 kg/ha per yr) in some ponds. Aqua Finca de Camerones concentrates on harvesting 8-16 animals/lb (18-35/kg) in order to supply 20-35 tails/lb (44-77/kg) to its parent chain's Red Lobster Restaurants. They receive \$1.90-\$2.00/lb (¥ 986-1,038/kg). For this market it appears that at least 500 acres (202 ha) of growout ponds will be required to provide a return commensurate with an overseas investment risk for a U.S. corporation. In this regard, Aqua Finca de Camerones plans an extension to 700 acres (283 ha) beginning in early 1981. This will entail a hatchery expansion to a 300,000-gal (1,137,000 l) recirculating water reuse system. Aqua Finca de Camerones plans call for cooperative ventures with local Hondurans whereby the former will provide postlarvae, technology, food, and guaranteed production purchase. The ponds will be built by the local entrepreneurs who then grow the prawns.

The Hawaiian Industry

Prawn culture in Hawaii is economically viable (Shang and Fujimura 1977; Lee 1979). The present industry was built upon the development of mass rearing techniques (Fujimura and Okamoto 1970) and under the guidance of the Anuenue Fisheries Research Center which provides seedstock to aquafarmers and

¹⁰Information provided by Ed McSweeney, Prawn Research Director, Weyerhaeuser Corporation, Research and Engineering Aquaculture, P.O. Box 1584, Homestead, FL 33030.

¹¹Red Lobster Inns of America, Inc., P.O. Box 13330, Orlando, FL 32809.

¹²Information provided by Ronald E. Wulff, Technical Director for Aquaculture, Aqua Finca de Camerones, Aquaculture Farm Ltd., Apartado 677, San Pedro Sula, Honduras, C.A.

⁹¥ 236 = \$1.00.

engages in a major extension program involving pond site selection, construction, management, and product handling. The extension services are available to all prawn operators and seedstock is provided free for a 3-yr period under a contractual arrangement.

The following is taken from Lee (1979).¹³

"In 1970, Hawaii had 1.5 acres (.61 ha) of prawn ponds. The industry has since expanded to a total of 275 acres (111 ha). Growth is expected to reach an additional 900 acres (364 ha) in the next four years.

"The industry consists of 13 part-time and eight full-time operations. These range in size from .25 acres (.103 ha) to about 100 acres (41 ha). Sixteen farms are located on Oahu, two are on Kauai, and three are on the Island of Hawaii.

Table 1. Average size of freshwater prawn farms (modified from Lee 1979).

Number of farms	Average	
	Acres	Hectares
10	.5	.2
4	2.5	1.03
2	6.4	2.62
3	19.3	7.9
2	95	38.5

"From 1972 to 1977, prawn production increased annually from 4,000 (1,818 kg) to 55,000 (25,000 kg) pounds. From 1977 to 1978, production doubled. As of October, 1979, 176,400 pounds (80,182 kg) have been produced. This rapidly increasing supply of prawns will soon require a coordinated market development program. Promising areas for future market expansions are the tourist and resident sectors of the local market and export markets in Japan and the U.S. Mainland. This expansion will necessitate further research into product processing and handling, and promotional and advertising campaigns.

"The wholesale price to the farmer for freshwater prawns was at a constant \$3.50 per pound from 1972 to 1976 (Table 2). The price rose to \$3.75 per pound (¥ 1947 kg⁻¹) in 1977 and reached a weighted average of \$3.82 (¥ 1983 kg⁻¹) per pound in 1978. In 1979, the wholesale price was approximately \$4.00 (¥ 2077 kg⁻¹) per pound. The forecast for 1980 suggests that prices will remain at around \$4.00 per pound (¥ 2077 kg⁻¹).

¹³Pounds and U.S. dollars are converted to kg and ¥ and inserted parenthetically by the author for the purpose of discussion.

Table 2.—Size, production, and value of freshwater prawns in Hawaii, 1972-79 (1 U\$ = 236¥). Modified from Lee (1979).

	1972	1973	1974	1975	1976	1977	1978	(As of Oct.) 1979	Total expected 1979
Acres	1.5	1.5	5	26	26	33	107	275	340
Hectares	0.61	0.61	2.02	10.53	10.53	13.36	43.32	111.34	137.65
Production									
lb	4,277	4,378	10,960	40,259	43,300	54,937	110,159	176,400	257,900
kg	1,944	1,990	4,982	18,300	19,682	24,971	50,072	80,182	117,227
Value									
U.S. \$	14,970	15,323	38,360	140,907	151,550	206,014	420,000	705,600	1,031,600
¥ ¹	3,532	3,616	9,052	33,251	35,762	48,619	99,293	166,538	243,480
Wholesale									
Price/lb (U.S. \$)	3.50	3.50	3.50	3.50	3.50	3.75	3.82	4.00	4.00
/kg (¥)	1,817	1,817	1,817	1,817	1,817	1,947	1,983	2,077	2,077

¹ × 1,000.

"Production for 1979 is estimated to be 257,000 pounds (116,818 kg). This is much lower than was expected at the start of 1979 due to unusually cold weather during the first months of 1979, limited supplies of juveniles for stocking, construction delays, and the generally optimistic expectations of farmers. . . ."

Table 2 and Figure 5 show the growth of the Hawaiian industry for the last 7 yr or so. Table 3 gives production (kg/ha) for selected ponds located on aquafarms that are under the cooperative agreement with Anuenue Fisheries Research Center. Table 3 provides a more accurate picture of production in kg/ha per yr than does Table 2 which does not reflect the fact that some ponds, although under culture in that calendar year, have not contributed a full year's production data. Consequently, industry-wide average production appears much lower in Table 2 than the actual production based on producing ponds.

The Hawaiian industry is a young one and, despite its success, it does have a long way to go before it develops into a vertical integrated food production sector analogous to other agricultural sectors. The biological problems and unanswered questions that presently constrain the Hawaiian industry are discussed later. They stem from close examination of the properties and unknowns that are characteristic of the present stocking, growout, and harvesting system.

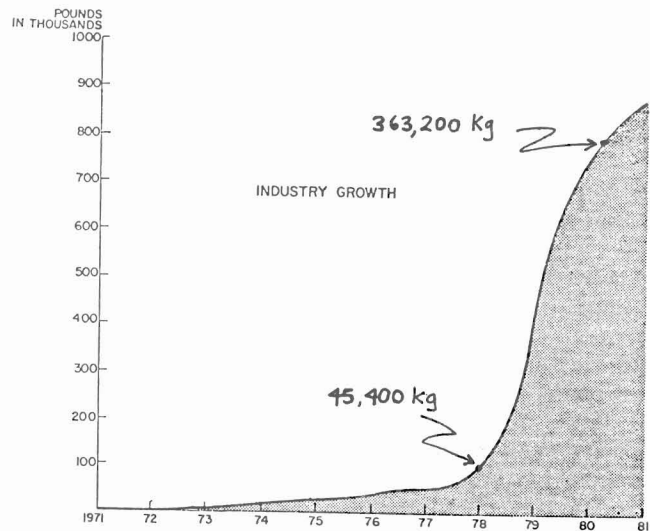

Figure 5.—Growth of the freshwater prawn industry in Hawaii, 1971-81 (from Lee 1979).

Table 3.—Production data by pond size for selected ponds under cooperative agreement with Anuenue Fisheries Research Center extension program. Ponds were selected on the basis of providing a full year (12 mo) of monthly production data regardless of the starting calendar date. Data for second and third years should be considered in light of the small number of ponds in the data set for those years.

	Pond size								
	< 1 acre (0.40 ha)			1-2 acre (0.40-0.82 ha)			≥ 2 acre (0.82 ha)		
Production year	First	Second	Third	First	Second	Third	First	Second	Third
No. of ponds	15	5	2	19	5	1	5	4	3
Production (kg)	5,721	2,458	632	16,403	7,038	2,546	10,663	8,550	11,954
Hectares	3.13	0.80	0.23	9.63	2.67	0.730	6.40	5.30	4.25
Production (kg/ha)	1,830	3,097	2,789	1,704	2,634	3,495	1,660	1,612	2,812

Hatchery

The first step in the Hawaiian production cycle involves obtaining gravid females from commercial ponds. No separate broodstock ponds are maintained by hatcheries. A strain called the "Anuenue" strain is presently utilized in all hatchery and pond production although other strains are under evaluation (Malecha 1977). Prawns mate in commercial ponds and females brood their eggs. Embryological development in *Macrobrachium rosenbergii* takes about 15 d and experienced hatchery operators can tell by the egg color about when hatching will occur and thereby capture only females that will hatch in keeping with a predetermined starting time for the first hatching cycle.

At the Anuenue Fisheries Research Center (AFRC) hatchery, females are brooded in 300-gal tanks. Eggs hatched into free swimming larvae are then transferred down into the larval rearing tanks. Initially about 1×10^6 ($\approx 130/l$) larvae are kept in one tank. This is split into 300,000 larvae ($\approx 43/l$) during the 3-wk or so development cycle. On the average 150,000 PL's/tank (≈ 15 -20 larvae/l) are produced. Larvae are fed newly hatched *Artemia* nauplii and strained fish flesh. The latter is made up in three particle sizes by means of forcing fillets of tuna through screens with the pressure from a stream of water. Larvae are reared in water containing about 5×10^5 to 1×10^6 cells/ml of unicellular phytoplankton, usually *Chorella*. This "greenwater" is cultured in large 5,000-gal (18,950 l) circular tanks and pumped into the rectangular larvae rearing tanks. The latter are flushed every 2 d after the first 12 d. The phytoplankton-rich "greenwater" increases survivability by maintaining good water quality through waste removal. In essence, the "greenwater" is a biological filter. Larvae may passively ingest the phytoplankton cells but they do not assimilate them into their tissue as shown by Cohen et al. (1976). Other *Macrobrachium rosenbergii* hatcheries have raised larvae to PL with good success using other biological filtration besides "greenwater" for water quality maintenance.

Ponds

The AFRC has developed a pond management strategy that consists of regular stockings of earthen ponds with hatchery-reared juveniles and regular, selective harvesting of marketable prawns. PL's are stocked as soon as possible following metamor-

phosis. At this time PL's are about 1 cm and are stocked at a rate of about 1.5 animals/ft² (16.14 animals/m²) of pond bottom.

Pond sizes vary from 0.25 to 4.0 acres (0.10 -1.64 ha) and they are of all shapes from nearly square to those with length-to-width ratio exceeding 3 to 1. Embankment slopes vary from 1.5:1 to 2.5:1 depending on soil types. The total land area required for a 1-acre pond is 1.20 ha or 112.4% of the actual pond area in order to allow for 15-ft (4.6 m) wide berms and access roads surrounding the ponds.

Grass is planted on road banks for bank stabilization and to provide shelter for young and molting prawns and to foster natural productivity to supplement the prawn's diet.

Ponds are usually supplied with water from wells or stream diversions which flow continuously at rates varying from 15 to 25 gpm/acre. Discharge rates are usually 5-15 gpm/acre (18.95-56.85 l/min per ha), taking into account natural evaporation and seepage. The water delivery system consists of pipes running from the main line to the "head" of the pond. An outlet is located at the opposite end. Farmers try to maintain a rich bloom of green algae (500,000 to 2,000,000 cells/ml) in each pond. Feeding is usually done once in the evening by means of broadcasting from the pond banks. Prawn farmers are currently using a ration of broiler starter which costs about 14¢/lb (¥ 73/kg). The current average conversion ratio is about 3.3:1 (exact information is not available).

Growth and production vary from pond to pond. Figure 6 shows a typical growth curve of a population of prawns in Hawaiian ponds. The two most important characteristics of this curve, which are typical of those in other studies (Smith et al. 1978), are sexually dimorphic growth and heterogeneous individual growth. The latter was first noticed by Fujimura and his colleagues during the early pond growth trials and was a major deciding factor in the choice of the harvesting method known as the "Continuous Harvest System," whereby "new growth," i.e., market size animals, are supposedly culled by periodic seining from the rest of the undersized animals, called "runts," which would remain in the pond and grow to replace the previously culled "bulls." In theory, this harvest system would provide a constant production supply needed in a fledgling industry where postharvest storage capacity was not developed and consistent market consignments had to be met. There are several drawbacks to the Continuous System, as discussed in Malecha, Polovina, and Moav (1981). Figure 7 shows a typical length-frequency distribution of prawn sizes in ponds

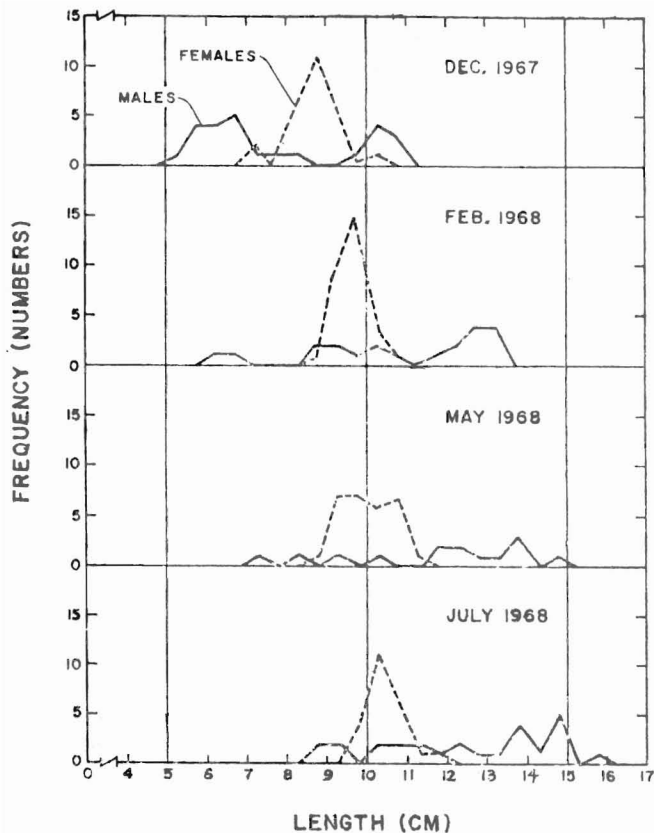

Figure 6.—Length frequency distribution for males and females sampled from an earthen pond in Hawaii. Distributions show sexual dimorphic growth (from Fujimura and Okamoto 1972).

undergoing harvesting in which prawns from the previous stocking are selectively removed first.

Approximately 7 to 9 mo after the initial stocking, selective harvesting begins. A seine net with a bag attached to the trailing end is used to cull large prawns. A team of three or more workers enters the pond at one point and pulls the leading edge of the seine net around the perimeter. After the pond, or a portion of it, has been completely encircled and the leading edge of the net returned to the point of entry, the net is then pulled in and the bag closed off. A three-man crew can harvest approximately three 0.5-acre (0.20 ha) ponds per day.

After the entire net is pulled in and only the bag remains in the water, the prawns are scooped out of the bag, sorted, and loaded by hand into transportation tanks. The harvesting efficiency, or percent of desirable prawns caught, depends on the workers' skill and pond bottom and bank conditions. Generally the method captures only 50 to 75% of the marketable prawns in the pond, with only a few undersized ones.

Harvesting continues at a nearly constant rate with decreases in yield during various periods. The reason for the fluctuations in the production is not known. All in all, stocking and harvesting management strategies do not appear to be optimum so there is ample room for experimentation and improvement.

Postharvest Handling and Processing

Almost all prawns grown in Hawaii are marketed either alive or chilled on ice. Some farmers blanch whole prawns for 20 s at 150°F (65.6°C) at the pond site and then pack the animals in ice for delivery. This procedure only safely extends shelf life by about 4 d, even though local market outlets prefer a longer shelf life rather than have high inventory turnover. Of course exploiting export markets will demand a long shelf life.

There seems to be little need for R & D in the food science and technology areas regarding postharvest handling and processing. Any new materials and procedures that may be needed can be developed from modifications of the "off-the-shelf" procedures and technologies readily available in the seafood and marine shrimp processing industries.

Figure 7.—Length frequency distribution from monthly samples showing that all prawns of the first rearing cycle were harvested by June 1972 in Pond No. 1 and by August 1972 in Pond No. 2 (from Fujimura 1974).

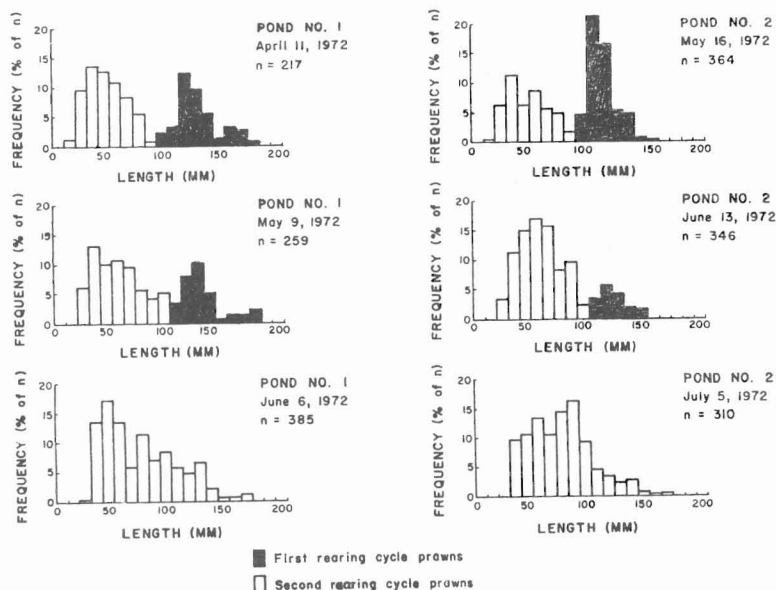

Marketing

Markets for freshwater prawns seem to be little different from those of other crustaceans of similar size and price. Demand for crustaceans (and all aquatic foods) can be expected to rise in the coming years so that emphasis in the area of marketing should be to provide a consistent high quality supply.

In Hawaii, prawns are marketed between 6 and 10 count (6 to 10 animals/lb, \approx 13-22 animals/kg) with the heaviest emphasis between 8 and 10 count. The harvest seining captures only these sizes. However, pending the demonstration of its economic feasibility, many more size classes can be marketed ranging from the "cocktail shrimp" or "bait" category to the lobster size (1 lb or 0.45 kg). In our search for new genetic stocks (see later) we have routinely encountered animals > 500 g in markets in Indonesia and New Guinea. It is possible that large animals can be marketed at premium prices and the smaller animals marketed at cost-effective prices. It is foreseeable that operating costs would be lower for the "cocktail" size prawns as a result of high turnover and low biomass of these small animals. In addition, less applied feeds are needed by animals of this size and the natural productivity in the pond is probably sufficient to provide their nutritional requirements.

BIOLOGICAL CONSTRAINTS

In Hawaii there appears to be no major biological constraint to profitable culture of *Macrobrachium rosenbergii* where appropriate climatic conditions, starting capital, economical feed, and good quality land and water are available. However, the acquisition of additional knowledge of existing management practices and/or the development of alternative ones is needed to improve production and/or profitability in order to induce additional investment and to insure the success of the industry presently being developed. I believe focus is needed on the pond growout system in all temperate, semitropical, and tropical cultures. Nursery technology R & D is important in temperate culture. Hatchery

technology, despite some design limitations, is adequate for good production (Sandifer et al. 1977).

Aquaculture and Agriculture

Before discussing specific biological constraints to prawn production, I would like to mention what I believe could be a type of general constraint to the progressive development of prawn aquaculture specifically and aquaculture in general. This is the conscious or unconscious attempt to force our R & D efforts into models developed for land-based agriculture. Table 4 gives a comparison of land-based plant and animal agriculture and aquaculture.

The obvious differences in habitat (water vs. air and soil) actually belie more fundamental differences which, in my opinion, must be recognized in R & D planning. The three most important are the: 1) Nature of the husbandry environment, 2) domestic history, and 3) indeterminate growth of the prawn.

In aquaculture systems, especially those that are pond-based, the production of the husbandry environment (i.e., the pond ecosystem) is as important to the production of the cash crop as the nature of the inputs which, as it turns out, are inputs to the entire pond ecosystem. As I discuss in a later section, pond-based aquaculture utilizes a "food web" not a "food chain." There is no bona fide analogue to this situation in terrestrial agriculture. The closest may be range management in beef cattle. Because of this we must be very careful not to use an inappropriate R & D model. A case in point is in the area of nutritional requirement research. Notwithstanding the need for complete diets in intensive systems, we must take into account the contribution of the pond ecosystem's natural productivity nutrient delivery systems and prawn feeding anatomy and behavior in designing our nutritional research. These are every bit as important to production optimization as having a thorough knowledge of the prawn's nutritional requirements and efficiencies. We do not want to be in the position of knowing the latter and not being able to do much about it because of the nature of the husbandry environment.

Table 4.—Comparison of aquaculture and agriculture organisms. See text for discussion. *indicates categories specifically discussed in text as the most important in distinguishing between land and water based agriculture.

Category	Organisms		
	Aquatic	Livestock	Plant
a. Growth medium	H ₂ O	air	air/ground
* b. Domestic history	0	long	long
c. Fecundity	v. high	v. low—med	low—high
d. Juvenile mortality	90%	5—20%	low
e. Regeneration of tissues	medium	0	medium
* f. Competition	v. intense	0—low	medium but ?
g. Body T ^o	cold	warm	cold
h. Mobility	high	low	none
i. Visibility of individuals	v. low	high	high
j. Mating potential	"diallel"	1/2 sibs, full sibs	selfing
k. Genetic engineering	difficult	no	possible
* l. Growth characteristics	indeterminant	determinant	indeterminant
* m. Mixed culture?	Yes: polyculture	none	v. little
* n. Diversity of husbandry systems	v. high	v. narrow	medium to narrow
* o. Relations in the wild	traceable, strong	weak in most cases	traceable in most cases

Another major difference between aquaculture and land-based agriculture is the greater variety of husbandry environments and multispecies culture available in aquaculture. I think we must not allow single species characteristics of our land-based animal systems to restrict us from developing, as thoroughly as possible, the polyculture systems peculiar to pond aquaculture.

The lack of domestic history in prawns like most other aquaculture organisms means that our breeding and selection programs must be designed accordingly. For one thing, the technology of experimentation has yet to be worked out so that the prawn can be genetically optimized. I discuss this at the end of this paper. This problem is true of other aquatic species. For example, the Israeli carp breeding group (Moav and Wohlfarth 1973) spent years developing experimental technology. In fact it was almost a decade between the time they began their work and their publications in referenced journals (Moav et al. 1975; Moav and Wohlfarth 1974; Wohlfarth and Moav 1972; Wohlfarth et al. 1975). These publications, as well as others, demonstrated that methodologies peculiar to carp breeding had to be developed along with the breeding work per se. In particular, specialized statistical manipulations were needed to deal with the effects of competition in a species with indeterminate growth (Moav and Wohlfarth 1974).

Prawns also have indeterminate growth. This means an individual can be almost any size at a given age depending upon the environmental conditions. Because of this, intrapopulation competition causes heterogeneous individual growth making production a function of the population size frequency distribution as well as inherent physiological capacity. There is no analogous situation to this in animal agriculture; we cannot expect to establish a crustacean analogue to weaning weight or 205-d weight gain as done in beef cattle breeding.

Nursery and Intensive Systems

In temperate climates, the development of nursery technology to "extend" the pond growing season is needed (Sandifer and Smith 1978). A number of studies (Eble et al. 1977; Forster and Beard 1974; Kneale and Wang 1979; Mancebo 1978; Sandifer and Smith 1975, 1977, 1978; Smith and Sandifer 1975; Wickens and Beard 1974; Willis et al. 1976) have shown the production potential of nursery systems but they, like other intensive culture systems, are constrained by the inability of the prawn to achieve high enough production under crowding to offset operating costs. As clearly seen in the size frequency graphs of Sandifer and Smith (1975), part of this is due to the heterogeneous individual growth rate. However the costs of early growth under intensive culture can be offset by the profits of a pond culture phase (Fig. 4; Sandifer and Smith 1978).

Nursery system development mandates ancillary studies on basic nutritional requirements of the prawn since complete diets will have to be developed to sustain prawns at optimal growth in intensive rearing systems which have essentially no "natural productivity." Several groups are engaged in this work (Table 1).

Consequences of Feed Application in Culture Ponds

The development of an optimum pond production system will involve an increased capability to efficiently and confidently manage the pond as an aquatic ecosystem which provides prawns with shelter, food, waste removal, and living space. In this regard, prawn production is the same as the production of trophic levels in other aquatic ecosystems (Ivlev 1945). Consequently "feed"

applied to the pond must really be considered an energy input to an ecosystem and not "feed" in the traditional agricultural sense. With the exceptions of systems like heavily manured polyculture ponds in Israel (Moav et al. 1977), no other ecosystem, production or otherwise, is characterized by such large energy inputs as prawn ponds and other semi-intensive and intensive warm water aquaculture ponds.

Little is known about how much of the applied feed is utilized directly by the prawn, how much is lost, or how much is cycled to the prawn through other components of the pond ecosystem.

The prawn, like other caridean shrimp, is relatively inefficient at food ingestion. It does not possess a gastric mill like some penaeids, but rather manipulates and masticulates its food outside its buccal cavity with its anterior appendages (Patwardhan 1935a, b). Unless food is well bound, particles become dislodged and are swept away by the prawn's exhalant gill current. Moreover, unless prawns are maintained in a hungry state, they are slow to react to and ingest their food. This is unlike some other fish species which swallow whole, floating pellets and consume almost all applied food with little wastage.

Even if prawns were capable of consuming most of their food without waste, feed applied to the pond would have to be bound in a water-stable form in order to minimize its disintegration on the pond bottom. Feed binding agents have been identified but seem too costly to be utilized on a large scale (Forster 1972).

Dispersed particles of feed pellets provide attachment sites for aquatic microbes in a way that is analogous to situations in other ecosystems where allochthonous organic plant matter (leaf fall, macrophytic particles) sinks to the pond bottom and then is immediately colonized by microbes to form detritus (Olah 1972). Following attachment, microbes utilize dissolved organic and inorganic nutrients for growth. Saprophytic functions proceed when sufficient microbial populations become established on the particles (Dickenson and Fugh 1974; Hargrave 1972).

Another important result of current feed application practices may be the leaching of dissolved organic matter into the water which may provide: 1) Nutrients for primary production (Cowan and Lee 1973; Turner 1978), 2) dissolved organic matter for heterotrophic metabolism and growth (Hall 1975; Iverson 1973; Paerl 1974), and 3) dissolved organic matter for the formation of particulate organic matter which can be used as a substrate for further microbial growth (Lush and Hynes 1974; Floodgate 1972; Paerl 1974, 1978). All three of these processes result in the production of particulate organic matter which represents a potential food source for prawns.

Although no leaching data are available for the various feed pellets, most are largely composed of water-soluble plant material (soy bean meal, cereal, bran, etc.). In other ecosystems studied, especially estuarine and stream systems, allochthonous organic plant matter begins leaching dissolved organics almost immediately upon contact with water (Lock and Hynes 1976).

Most of the currently used prawn feeds disintegrate within a few minutes after being placed in water. Probably a significant amount of inorganic nitrogen and phosphate, as well as dissolved organic matter, leach out from these pellets within 30 min. Therefore, prawn feed pellets probably contribute substantially to the nutrition of nonprawn organisms in the pond ecosystem.

Macrobrachium rosenbergii, like other caridean crustaceans, is a crawler and lives in the epibenthos of a pond. In many ecosystems where the major food chains are detrital, the benthic sediments are the major source of nutrients for the biota in the ecosystem. In these cases, epibenthic and infaunal invertebrates, including decapod crustacea, derive their entire nutritional benefit from

their proximate environment through various forms of detrital ingestion (Darnell 1964; Fenchel and Jorgensen 1977; Odum and de la Cruz 1963, 1967).

Johannes and Satomi (1966) demonstrated that the marine shrimp *Palomonetes pugio* can utilize its own feces for its main food source; assimilation efficiencies of fecal pellets were as high as 70%. Frankenberg and Smith (1967) showed that seven species of crustacea, including two decapods, ingested and utilized feces produced from fishes and other invertebrates to meet a significant portion of their metabolic need.

All in all, I think it is safe to conclude that, unless a stable food pellet is developed which can pass largely intact into the cardiac stomach of the prawn, the feeds applied to ponds in the manner currently practiced primarily serve to nourish animals and plants in the pond ecosystem other than the prawns. To what extent this occurs is uncertain but almost any optimum feed management strategy will have to be predicated upon the fact that there are more than two steps in the transfer of the energy within a prawn production pond, i.e., prawn production is not a function of a food chain:

(input) → applied feed → prawn → prawn production → (output)

but a food web:

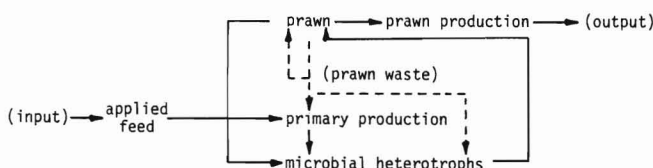

The consequences of the feed application, especially as it applies to the nutrient loading of the pond and the relative roles it plays, along with natural pond productivity are important areas of research that need to be addressed in an effort to design a maximum feed and feeding management system.

“Crises of Scale” and Self-Management in Pond Ecosystems

Shang and Fujimura (1977) showed that monoculture of prawns benefits from an economy of scale, i.e., larger farms can be expected to be more efficient and more economical. Not surprisingly, farms in the 300 to 1,000-acre (123-410 ha) range are being developed in Hawaii and elsewhere. However, it is not known to what degree the advantages of the economy of scale will be offset by the disadvantages of “crises of scale.” There have not been sufficient data to perform an accurate actuarial analysis of production losses which would allow an assessment of the magnitude of these crises and an optimum risk management strategy designed to cope with them. Until recently, prawn aquaculture has consisted of small-scale operations in which individual aquafarmers managed a few acres of ponds. For example, the industry has expanded since 1976 in Hawaii from a few acres to the present size of 275 acres (113 ha).

There is no doubt that large prawn farms will present management problems which cannot be solved by techniques developed for smaller operations. For example, it will be difficult and expensive for the owner of a large aquafarm to frequently police his ponds in order to prevent anoxia. Therefore ponds in large-scale operations will have to, in effect, “manage themselves” to a great

degree. In the short term, “prophylactic” management practices must be designed to minimize “crises.” In the long term, however, we must increase our knowledge of the pond as an ecosystem in order to insure the success of larger prawn farms and an expanded industry.

Since the respiratory activities of the phytoplankton and bacteria undoubtedly contribute substantially to the oxygen demand of the water column and sediments, a logical first step in the direction of achieving pond “self-management” will be to reduce or in other ways more effectively manage the biomass of these organisms. However, in the long term, the effective management of pond culture will be predicated upon sound ecological knowledge of the pond ecosystem. We will have to apply skills of the aquatic ecologists and approach the pond culture system as a highly eutrophic aquatic ecosystem. I make a point of this because pond aquaculture in general and prawn pond aquaculture in particular, with the notable exception of Boyd (1979), suffers from application of traditional land-based agricultural models wherein the “ecology” of the husbandry environment is rarely, if ever, a subject of consideration. Indeed, it does not have to be. No one would consider a chicken house or feedlot as an “ecosystem.” It would be a mistake if we apply the typological thinking of terrestrial animal agriculture to prawn ponds and consider the latter as some kind of “aquatic cage.” As I discussed in the previous section, unless we change the prawn’s “sloppy” eating habits and its masticatory anatomy, there is little chance that a pond will simply be an aquatic cage in an efficient food “chain.” In my opinion, prawn pond aquaculturists should not force the pond into this mold but rather should utilize its inherent production properties and capabilities through the greater stimulation and use of its natural productivity.

Sexual Dimorphic Growth

Figure 8 shows an interpretation of growth curves for male and female prawns. Sexual dimorphic growth can also be seen in Figures 6 and 7. Female growth begins to sharply level off much earlier than male growth. Consequently the former should be harvested and marketed at an earlier age and at a smaller size than males. This strategy has been an economically sound practice in the meat poultry industry (Soller and Moav 1973). The current continuous stocking and harvesting system practiced in Hawaii works in the opposite direction: Males are harvested first and females are allowed to grow until they finally make it to the

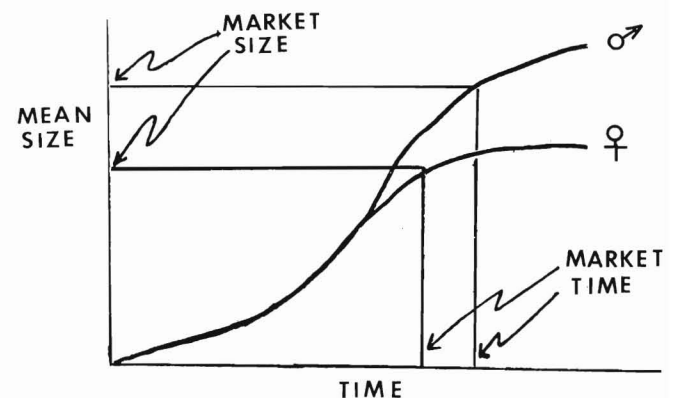

Figure 8.—Growth curve for mean size of males and females of a hypothetical population. Sexual dimorphism should be managed by harvesting females earlier at a lower weight.

desirable market weights. In batch harvest there is a significant difference in male and female production. Figure 9 shows that the shape of the size frequency distribution does not change for females at different culture densities, whereas the male distribution becomes more skewed. This may mean that 1) there is much less competition between females, 2) male-female competition is low or even absent, and 3) male-male competition is very strong.

All in all, it seems that the prawn's sexually dimorphic growth pattern should be either managed more effectively or changed.

Heterogeneous Individual Growth

Mention was made above of the fact that the heterogeneous individual growth is a major constraint to optimum production in

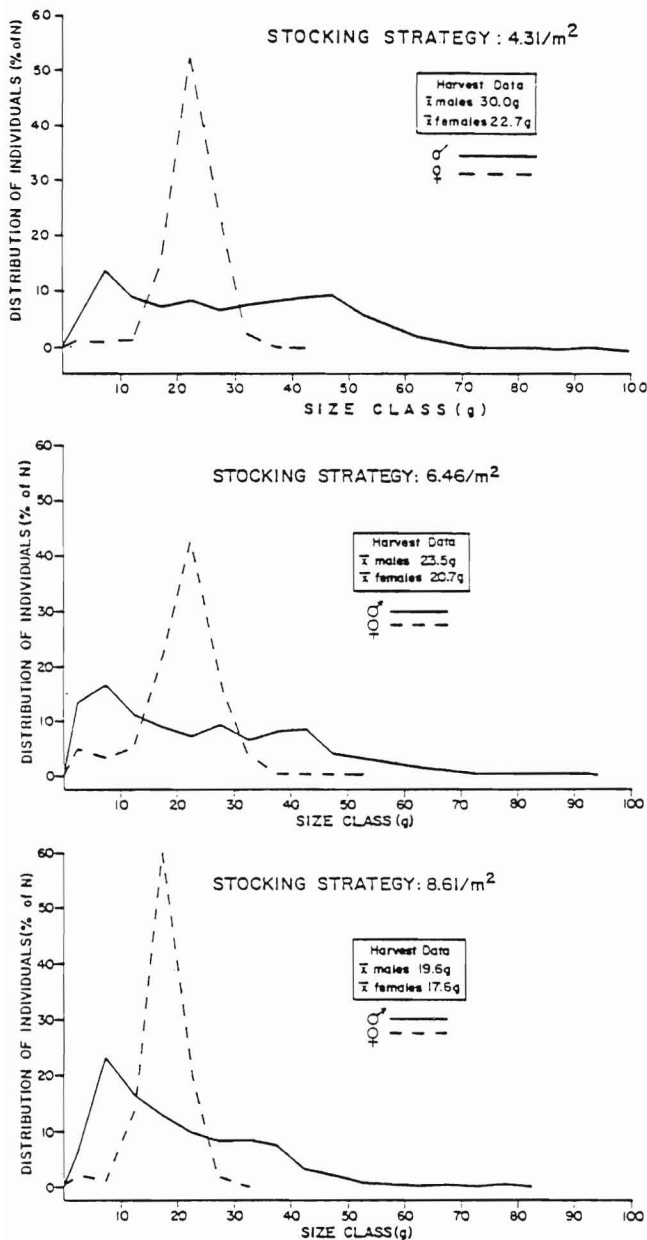

Figure 9.—Population structure of prawns reared in earthen ponds in South Carolina at three stocking densities. Mean stocking weight was 0.3 g and mean growing season was 162 d (from Smith et al. 1981).

one season growth trials, i.e., single batch harvests contain an array of sizes, all of which must be marketed (Smith et al. 1978).

The size frequency distribution in *Macrobrachium rosenbergii* "depensates" (i.e., the variance increases as the mean increases) as it does in fishes (Ricker 1958). However, *M. rosenbergii* populations heavily depensate and skew to the right (Fujimura and Okamoto 1970; Smith et al. 1978). "Typical" size frequency distributions are shown in Figure 9. Similar depensation patterns occur in carp and have been shown to entice group competition which magnifies slight initial size differences into large ones as the population grows (Moav and Wohlfarth 1974). Larger animals called "shoot carp" (Nakamura and Kasahara 1955) or "jumpers" (Moav and Wohlfarth 1973) continue to maintain the large size disparity between themselves and smaller animals by depressing the growth rate of the latter below optimum levels. These large carp seem to be equivalent to "bull" prawns (Fujimura and Okamoto 1970).

The bull growth suppression may not be permanent. Malecha (1977) demonstrated that if a population of juvenile prawns with a large size variance is graded into size classes, the largest animals in each size class attain approximately the same final size in the same time despite very different initial sizes. Similarly Nakamura and Kasahara (1957) found that runt fish are capable of increasing their growth rate when they are removed from the depressive effects of larger individuals. If the highly skewed depensated populations of *M. rosenbergii* are largely a result of intrapopulation competition, growth rates of smaller animals could be increased by grading them out of a depensated population into one composed of similar sized individuals.

I have obtained some preliminary results on heterogeneous individual growth. Figure 10 shows the result of an experiment in which skewed size frequency distributions developed in *Macrobrachium* populations whose individuals were reared in separate compartments but communal water and given ad libitum food as well as a comparable population where individuals were not separated from one another. Both populations depensate at the same rate (Fig. 11). If the heterogeneous growth was due mainly to competition for food, then the individually reared animals should not have shown the highly depensated pattern. Figure 12 shows the preliminary results of another experiment where animals reared individually in aquaria do not depensate but

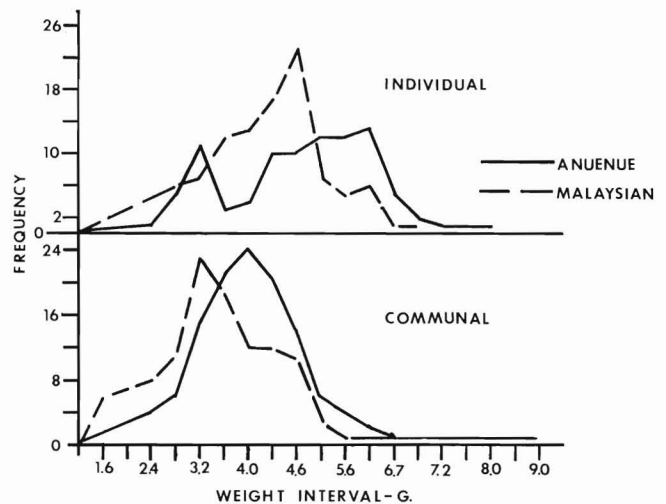

Figure 10.—Size (in grams) frequency distribution of individually segregated and communally housed animals from two strains. Sexes are mixed. Populations have depensated under both housing conditions.

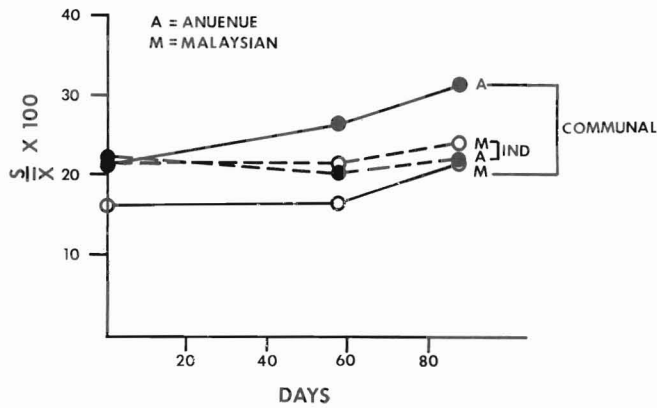

Figure 11.—Coefficient of variation (standard deviation/mean \times 100) for communally and individually segregated populations from two strains.

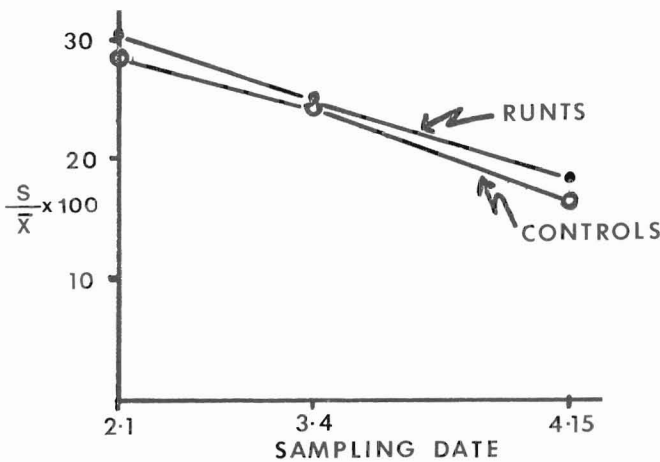

Figure 12.—Coefficient of variation for individual animals reared in separate aquaria. Runts were obtained from another system and were extremely small for their age (\approx 13 mo). Controls were size matched to runts and were the proper size for their age.

undergo reverse depensation. Other results of this experiment show that animals which are runtied (small for their age) grow faster than comparably sized control animals (normal size for their age). All in all, my work in aquaria and tank systems suggests that the greater part of prawn heterogeneous individual growth is due to suppressive effects exerted by large animals on small ones and that this effect may be mediated by a water borne crowding factor. Of course much more work is needed in this area before heterogeneous individual growth can be eliminated as a biological constraint in prawn culture.

CONTROLLED DOMESTICATION, GENETIC ASSESSMENT, AND SELECTIVE BREEDING

General

Domestication is a genetic selection process which works through geographic and reproductive isolation, inbreeding, and

small population size to produce evolutionary changes in species. The anthropological aspects of this are well documented (Zeuner 1963) but not much scientific scrutiny has been directed at the domestication process because the opportunity to study, document, and control the phenotypic and genotypic changes that occur in the domestication of livestock, poultry, and companion animals is limited. The opposite is true in aquaculture.

With the exception of some carp (Balon 1974) and trout (Hines 1976), cultured aquatic species are relatively undomesticated and, at first glance, indistinguishable from wild stock. Consequently, a cultured aquatic species can be traced back to its origin thereby aiding in assessing the domestication process. Such is the case with the cultured freshwater prawn, *Macrobrachium rosenbergii*.

The prawns propagated and grown commercially in many countries throughout the world (known as the "Anuenue" strain) came from a small founder stock collected near Penang, Malaysia, and shipped to Hawaii in the mid-1960's (Malecha 1977). Obviously the gene pool that gave rise to the Anuenue stock cultured in Hawaii and elsewhere has proven sufficient for profitable production. However, this may not be the only gene pool available to the aquaculturist for domestication considering the large distribution of *M. rosenbergii* (Fig. 13) which may be composed of intraspecific races differing from one another in various aquaculturally important parameters (Johnson 1960a, b).

We are attempting to use *M. rosenbergii*'s wide native distribution to uncover intraspecific variation available for domestication and assessing the degree to which it has progressed so far. This involves the development and characterization of genetic stocks and their hybrids developed from newly imported founders collected from throughout the species range (Tables 5, 6; Fig. 13). Our characterization is based on a widely diverse array of tests designed to uncover behavioral, physiological, developmental, morphometric, and electrophoretic variations. By emphasizing a wide range of different tests, we hoped to develop a priori reasons for further and more extensive testing in one area. The characterizations of the Anuenue stock, which has been under culture for about 15 generations and one recently developed from founders from the same geographic location (called "Malaysian"), allow one to assess the degree of incipient domestication which has occurred in *Macrobrachium rosenbergii*. Our objective was to investigate whether current culture practices should be changed in an effort to accelerate the domestication process toward an organism with more favorable characteristics.

Genetic Diversity

We performed electrophoretic analysis of gene-enzyme variation in *Macrobrachium rosenbergii* for the purpose of quantifying the amount of racial divergence among geographically separated natural populations. A total of 440 individuals from 11 localities spread from Sri Lanka to New Guinea, Palau, and the Hawaiian cultured stocks have been analyzed for genetic variation in 31 electrophoretically detectable proteins using techniques described by Tracey et al. (1975). Nei's (1972) measure of genetic distance was employed to calculate genetic similarity among the geographic populations as well as the cultured Anuenue stock in order to help me assess any differences seen between the Malaysian and Anuenue stocks.

Table 7 (originally developed in Stelmach 1980) shows the genetic distance among geographic populations and the cultured Anuenue stock. Genetic distances were calculated according to Nei (1972). The table shows that *M. rosenbergii* can be divided in-

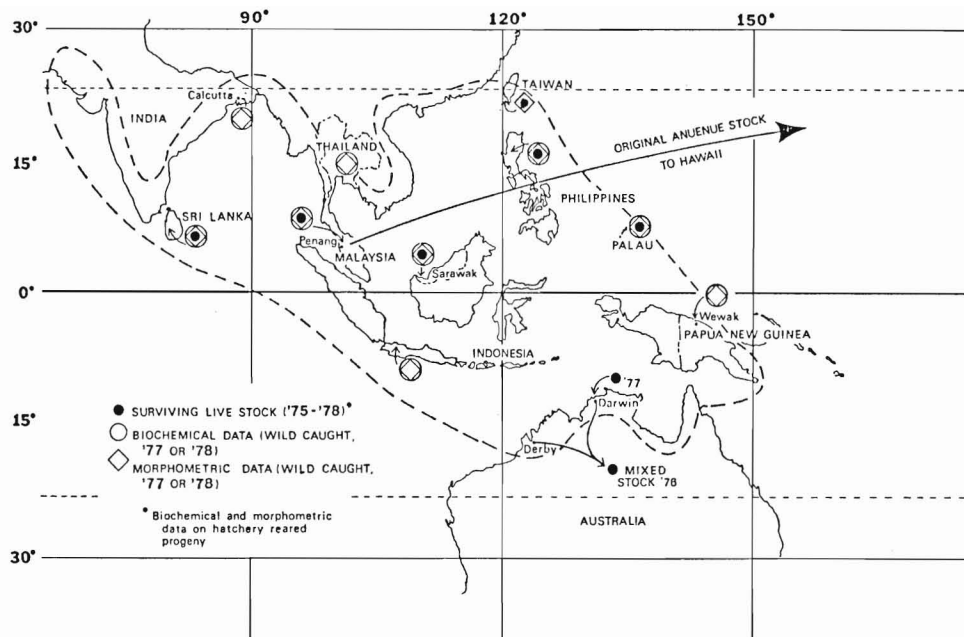

Figure 13.—Native distribution of *Macrobrachium rosenbergii* showing geographic origin of the Anuenue stock and areas visited in a field survey. Small closed circles refer to areas from which imported founders have been used to develop parental and hybrid progeny. Large open circles represent populations which were analyzed electrophoretically (i.e., biochemically). Diamond symbols represent areas visited from which morphometric data was obtained.

Table 5.—Parental and hybrid broodstock currently maintained at the Anuenue Fisheries Research Center in Honolulu for evaluation. Parental stock represent descendants of live-caught founder collected from *M. rosenbergii*'s native range (Fig. 13).

Parental broodstock		Hybrid broodstock	
Stock	Generation	Paternal	Maternal
Anuenue	Control	Anuenue × Sri Lanka	
Palauan	F ₂	Anuenue × Palauan	
Malaysian	F ₂	Malaysian × Anuenue	
Ceylonese ¹	F ₂	Anuenue × Australian (Darwin)	
Sarawak	F ₁	Anuenue × Australian B	
Thai (Thailand)	F ₁	Anuenue × Thai	
Australian "A," "B" ²	(F ₁ , F ₂)	Anuenue × Ceylonese	
Philippine	F ₁	Ceylonese × Anuenue	
Australian (Darwin) ³	Founders only	Anuenue × Philippine	
Sri Lanka ¹	Founders only	Anuenue × Sarawak	
Taiwan	Founders only	Ceylonese × Sri Lanka	
		Ceylonese × Australian B	

¹Ceylonese received in 1977; Sri Lanka received in 1976.

²Australian "A" and "B" traceable to orange egg and yellow egg hatches from a 1976 shipment.

³Shipment received 1977.

to a Western and Eastern group as has been pointed out by Hedgecock et al. (1979) in a preliminary report. This dichotomy in *M. rosenbergii*'s gene pool corresponds well to the zoogeographic boundary known as Wallace's Line.

Special note is taken of the genetic distance between the Anuenue and the other stocks. As shown in Table 7, the Anuenue stock has developed very little from its wild relative in the Western group. It must be pointed out that little divergence would be expected in alleles at allozyme loci.

If inbreeding has a profound effect on the gene pool of the Anuenue stock it would display increased homozygosity and decreased heterozygosity. Table 7 shows, however, that the Anuenue and Malaysian stocks, as well as the other stocks in the Western group, have very similar heterozygosity values. Overall intrapopulation variability is low: About 28% of the loci in an individual is heterozygous while the average percentage of polymorphic loci in each population is about 14%.

Our electrophoretic results support the conclusion that *Macrobrachium rosenbergii* has undergone substantial racial divergence over its natural range and that geographic populations represent a diverse genetic resource for prawn domestication (Hedgecock et al. 1979). Other work assessing various physiological performance characters (Sarver et al. 1979) also supports this contention.

Morphometric Conservatism

Changes in size and body proportions characterize domestication. Since the carcass quality of prawns is important in marketing it is important to know the relationship of hard nonedible exoskeleton parts to the soft edible parts ("the tail"); prawns are marketed by the pound whole and as "tails" with carapace, walking legs, and claws removed.

We compared allometric growth patterns between cultured and wild stocks and their hybrids in an effort to assess any favorable morphometric variation present throughout the species range which would be available for domestication and the degree to which the culture environment and hybridization affect these patterns. To do this we determined the growth and size relationships between several body characteristics (Fig. 14, Table 8) using the allometric equation $Y = aX^b$ and regression analysis. The

Table 6.—Breeding results for parental and hybrid matings (Table 5) compared with total matings conducted at the Anuenue Fisheries Research Center. Approximately 50% of all matings result in live hatches of larvae while a much lower percentage of those matings between ecotype stocks result in live hatches. This indicates a bottleneck in obtaining successful live hatches from newly imported founders probably due to lack of acclimatization to the hatchery environment.

Period	Total attempted	No. successful berried	% of attempts	No. successful live hatch	Live hatches as % of berried
10/78-9/79	507	251	40	148	59
10/77-7/79	1,068	464	43	212	46
	Matings of different stocks attempted				
10/78-9/79	21	13	62	1	8
10/77-9/79	66	38	58	14	37

Table 7.—Nei's (1972) genetic similarity values for geographic populations of *M. rosenbergii*. Data based on electrophoretic analysis of an average of 26 loci (from Stelmach 1980).

	Western						Eastern			
	Sri	Cal	Thai	Jak	Anue ¹	Sar	Phi	NG	Aust	Pal
Sri Lanka		.9669	.9668	.9633	.9590	.9598	.7355	.7327	.7088	.7339
Calcutta			.9998	.9996	.9978	.9979	.7347	.7318	.7070	.7325
Thailand				.9999	.9964	.9984	.7329	.7283	.7058	.7308
Jakarta					.9961	.9980	.7310	.7270	.7063	.7291
Anuenue						.9951	.7373	.7325	.7157	.7352
Sarawak							.7268	.7225	.6983	.7239
Philippines								.9958	.9526	.9990
New Guinea									.9487	.9955
Australia										.9543
Palau										
	Average heterozygosity levels per locus									
	.018	.029	.012	.008	.027	.020	.021	.026	—	0
	Average number of alleles per locus									
	1.32	1.24±	1.16	1.14	1.19	1.11	1.20	1.25	1.25	1.00
	Porportion of polymorphic locus									
	.32	.16	.12	.11	.15	.07	.10	.13	.11	0
	Average number of loci									
	28	25	25	28	27	28	20	24	28	28

¹Anuenue stock: Cultured stock derived from imported founders from Malaysia. No additional Malaysian sample analyzed electrophoretically.

reference dimension, X , was orbit length except in two cases. In one case both the dependent and reference dimensions were two separate segments on the same chela. This corrected for regenerating chelae which would be expected to display lower relative growth to orbit length. In the case of tail width comparisons, two separate tail dimensions were used as the X and Y variables. Our data was from three sets (Fig. 13): One from growing populations of cultured stocks developed from founders imported from Malaysia, Sri Lanka, Palau, and Australia prior to 1977, as well as control Anuenue stock; another from dead specimens from 10 geographic locations in New Guinea, Sarawak, Sri Lanka, India, Thailand, Malaysia, Indonesia, Taiwan, the Philippines, and Palau measured in a field survey conducted during 1977-78; and the third set from cultured hybrid groups bred from imported founder parents. Linear regression was performed on the paired comparisons divided by sex, geographic location, and culture conditions; 95% confidence intervals were determined for each analysis as

well as R^2 values. Based upon the overlap of these intervals, the subgroups were pooled first by sex, the location, then culture history. We could find no major differences in relative size or growth between sexes and geographic location in either the cultured stocks or wild stocks. Although there were statistically significant differences between some groups we were able to combine all the data from the various groups for each variable because of the overlapping confidence intervals. Table 8 shows preliminary results comparing cultured and wild populations for six variables including orbit length (OL), carapace width (CW), posterior tail width (T_1), and anterior tail width (T_3).

Table 8 also shows results of the allometric analysis in hybrid groups. We did find statistically significant differences among some hybrid groups but we do not interpret these as predictive biological differences which give evidence of heterosis. The slopes of the regression lines did not differ by whole integer values which would have indicated such a major effect.

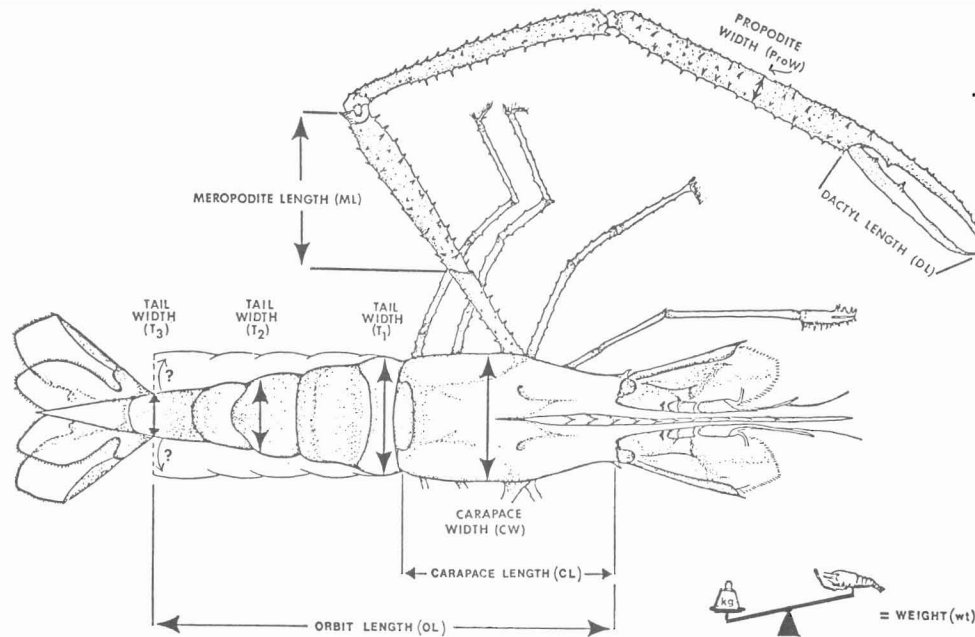

Figure 14.—Dorsal view of prawn showing variables used in allometric analysis. See text and Table 8.

Table 8.—Coefficients for the allometric equation $Y = aX^b$ cultured and wild populations. R^2 measures the closeness of fit of the regression line to experimental data. Variables are as described in Figure 2. Four comparisons showed isometry indicating that the rate of growth of the variables is the same in all sizes and ages. See Figure 14 for key to variables.

Variables		Data Set	a	b	Sample size	R^2
Y	X					
Wt	OL	Cultured	.018	3.151	988	.902
		Wild	.009	3.396	890	.962
CW	OL	Cultured	.149	1.152	988	.864
		Wild	.127	1.188	892	.968
CL	OL	Cultured	.271	¹ 1.144	988	.880
		Wild	.187	¹ 1.232	895	.980
T ₁	OL	Cultured	.158	¹ 1.080	370	.973
		Wild	.141	¹ 1.075	895	.962
T ₂	T ₁	Cultured	.797	¹ 1.008	370	.837
		Wild	—	—	—	—
T ₃	T ₁	Cultured	.464	¹ .949	370	.946
		Wild	.315	¹ 1.082	895	.939

¹Isometry.

Based on my preliminary failure to uncover economically important allometric size differences among stocks, we feel that there is little hope of finding, outright, one displaying a more favorable morphometric pattern than the presently cultured Anuenue stock. Furthermore, the lack of differences between cultured and wild populations indicates that *Macrobrachium rosenbergii* does not display ecophenic variation: New phenotypic expressions of the same genotype as a result of being brought from a wild to controlled husbandry environment (Spurway 1955; Hale 1962). "Ecophenes" are habitat forms which reflect a species' potential for phenotypic variation in the absence of genetic changes during domestication.

The lack of major differences between hybrid and parental groups for the allometric comparisons suggests no large positive or negative heterosis. I conclude that the parental populations do not

represent co-adapted genetic combinations which are disrupted by outcrossing. Morton et al. (1967) have made similar conclusions in their study of outcrossing among human races. Because of this, intraspecific crosses of ecotypes will not be expected to produce the phenodeviants (Spurway 1955) or "hopeful masters" that would greatly improve on *M. rosenbergii*'s conservative allometric patterns.

I conclude that if changes are required in the prawn's morphometric and growth patterns, rapid domestication of the prawn will have to turn to more radical, direct, genetic intervention to disrupt and change the genetic systems which control the body proportions and growth such as use of radiation mutagenesis, interspecific hybridization, and sex reversal.

Degree of Domestication

Recently we have compared the degree of incipient domestication that has occurred in the Anuenue strain. To do this I conducted a series of growth and tolerance tests on the Anuenue strain and a one-generation descendent stock (called "Malaysian") developed from founders from the same geographic location as the founders of the Anuenue stock. The former is assumed to be the putative domesticate and the Malaysian stock its wild, undomesticated relative. A detailed account can be found in Malecha et al. (1980). Only a brief review will be presented here. Table 9 summarizes the results.

In two cases, the temperature tolerance and the communal versus individual growth study, the Malaysian stock displayed a superior performance over the Anuenue stock. It is difficult to attribute these results to artifacts of the experiment. There is a possibility that the superior temperature tolerance of the Malaysian stock reflects an environmental effect and not a bona fide effect of the genetic background of the Malaysian stock.

It is unlikely that the difference could be attributed to a maternal \times brood effect since the prawns were several months old when the experiment was started. Moreover, maternal and brood effects should diminish through time. This is not the case; the Malaysian

Table 9.—Summary of results assessing the degree of domestication in *Macrobrachium rosenbergii*. Tests evaluated the Anuenue (putative domesticate) and the undomesticated Malaysian relative. For further details see Malecha et al. (1980).

Treatments	Environment	Duration ¹	Size range ²	Treatment effect	Genetic effect
Replicated, Experimental					
Growth:					
Communal/Indiv. housing	Tanks	85 d	1.3-5.7 g	Yes	M > A
Crowding levels	Aquaria	30 d	PL-0.10 g	Yes	M = A
Density levels	Tanks	85 d	1.4-4.8 g	Yes	M = A
Temperature levels	Aquaria	30 d	PL-0.10 g	Yes	M = A
Salinity levels	Aquaria	30 d	PL-0.10 g	Yes	M = A
Tolerance:					
Temperature	Aquaria	24 h	PL's	Yes	M > A
Unreplicated, Observational					
Pond growth	2 ponds	91 d	PL-0.10 g	—	M $\frac{?}{>}$ A
Larval growth	Tanks	40 d	Larvae	—	M $\frac{?}{<}$ A
Larval development	Tanks	29-39 d	Larvae	—	M $\frac{?}{<}$ A

¹Duration is given as the longest interval of any one trial.

²Upper size range reported as the largest value in any one trial.

group was growing fast in one trial at both 57 and 85 d. It is important to note that there were 17 other trials which compared the two strains for growth and no differences were seen. Since the Malaysian-Anuenue comparisons involved offspring from single families, individual variation may be confounding our results.

The general tendency for the Malaysian group to have a longer larval development time (Fig. 15) than the Anuenue may perhaps reflect incipient domestication in the latter in larval development. It is normal hatchery practice to discard slow developing larvae which may have served to genetically change the larval development pattern of the Anuenue stock in the direction of faster larval development. However, I cannot be sure of this from my results since they were merely observational. More rigorous experiments on larval development between the two groups will have to be conducted.

I feel that if further testing reveals a bona fide genetic superiority of the Malaysian stock over the Anuenue stock a "reverse" domestication process could be occurring for some characters as the result of the current management practice.

The culture environment itself (McCauley 1978; Doyle and Hunte 1981) imposes selection pressures which cause an evolutionary change in the population's capacity to survive; this is collectively known as "fitness." Unless man controls every aspect of this capacity (i.e., its life history), then changes can be expected in an organism which benefit it and not necessarily the economics of man.

It is not certain just how *Macrobrachium rosenbergii* has maximized its fitness in the culture environment, but it is possible that the current practices in Hawaii actually may be directly selecting genetically inferior organisms (in terms of human criteria). For example, one scenario could involve the avoidance of genetic death imposed by the pond harvest, i.e., if males who avoid the harvest cull are able to reproduce more often than others and avoidance is related to slow growth rate, it follows that genetically

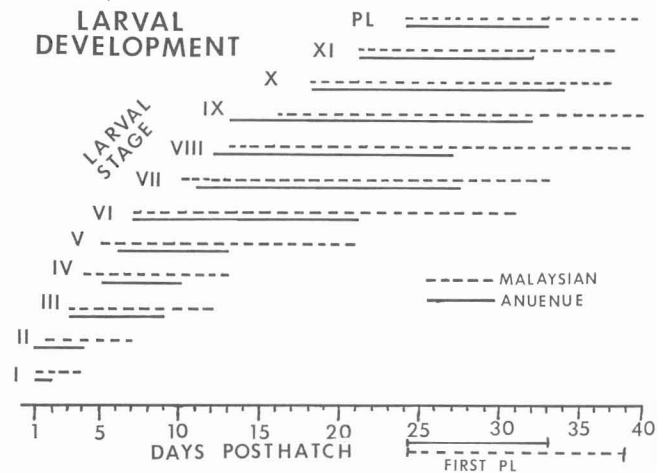

Figure 15.—The first day (represented as a range) at which a particular larval stage appeared in larval rearing tanks containing either Malaysian or Anuenue stocks.

inferior, but net-wise, animals are reproducing more often perhaps because they have longer residence time which may maximize chances of mating with females. The question is to what degree these animals contribute to the broodstock for PL production for restocking ponds.

Female broodstock are obtained from commercial harvests so they are large but whether they represent genetically superior animals is not known. Figure 16 portrays three possibilities that could occur in selecting female broodstock under a system of continuous harvesting as practiced in Hawaii. Females being used for broodstock could represent the full spectrum of genetically controlled growth rates. In some circumstances the worse case scenario shown in Figure 16 could prevail, i.e., the largest animals could represent the older but slowest growers. Depending upon how much of the variance in growth rate is genetically controlled, the present practice of broodstock selection could be directly counterproductive to progressive domestication of *M. rosenbergii*. Therefore some changes may have occurred in broodstock selection in order to improve stock rather than just propagating it. However the management for most farms involves seine harvests and multiple stocking so there is no way to establish the age of any prawn collected from the pond and no way to control the mating of the broodstock females. Because of this there is no control over parental breeding value, i.e., the genetic worth of an animal's genotype. No other modern agricultural system relies on such "natural service" in this manner. Batch harvesting systems (Fig. 4) can be used to establish breeding values for broodstock.

Since the cultured environment is much different than what *Macrobrachium rosenbergii* is exposed to in the wild, one would expect that the Anuenue genotype diverged from its founder stock even without conscious selection. There are several possible explanations why this does not appear to have occurred. One is that the selective pressures relevant to the characters I examined are the same in the natural and cultured environments. This seems very unlikely. Another possibility is that there is not enough genetic variability within the Anuenue stock upon which selection could act. This again seems unlikely since there is a lot of variation in *M. rosenbergii* in growth rate, tolerance to low temperature, and various other parameters (Hedgecock et al. 1979; Sarver et al. 1979).

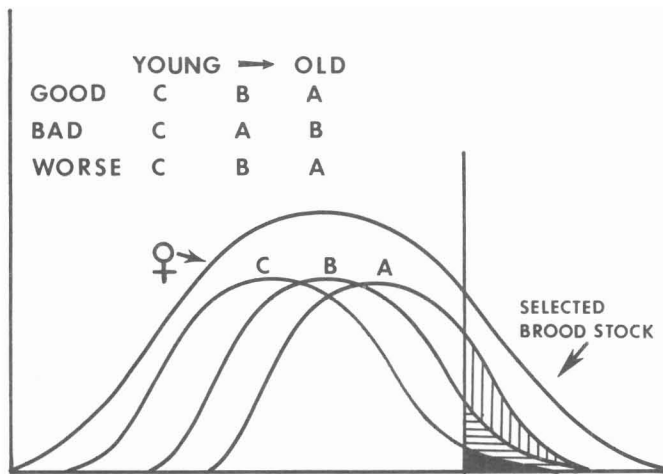

Figure 16.—Three possible interpretations of a pond size frequency distribution of females cultured in ponds with continual harvest by seining some of which are removed for broodstock. Underlying distributions A, B, C represent different age classes as shown in the table. Genetically inferior broodstock could be selected if culled females represent older, slower growing individuals.

Other factors may be swamping out evolution within the cultured environment. Since larval survival is nearly 50% in many hatcheries (Sandifer and Smith 1977), compared with much less than 1% in the wild, it is possible that the development of successful mass rearing techniques served to “flush” the *M. rosenbergii* gene pool in a manner similar to that described by Carson (1968, 1975) for the genetic events which accompany certain types of speciation. “Flushes” are numerical increases in numbers that accompany population growth during periods of relaxed selection. “Flushes” are thought to foster genetic events which “open up” a species’ genotype by causing the appearance of new genetic combinations which may be selected for (or not selected against) under the new selection regimes. These genetic events could occur rapidly if a species is removed abruptly from the ecological niche in which it has evolved and placed in a different environment such as during colonization of a new habitat or bringing an organism under culture. Both processes would be expected to lead to selection for a new adaptive optima (Wright 1963). The new environment could be a major factor in speciation following colonization and severe selection pressure can be imposed by a domestication husbandry regime. Spurway (1955) has illustrated the latter by describing the practice of “winnowing” whereby cereal crop seeds are passed through screen mesh. Those seeds that fall through are used, those left out are not. This leads to 100% selection against certain size groups. It seems there is no question that the *Macrobrachium rosenbergii* gene pool has been “flushed,” but it seems not to have been “winnowed” such that differences appear between the cultured and wild stocks.

One final note. Changes during domestication can be expected to occur but they may not always be favorable, i.e., wild relatives or incipient domesticates are actually genetically superior to the cultured stock. Under culture man is the predator since the outcome of culture is death—killing the organism for food. It is obvious then that organisms, unless managed not to do so, will evolve adaptations to survive this outcome. Consequently management practices must be designed to directly manipulate the variables considered important and avoid unfavorable adaptations. In addition one must not fall into the trap of designing management systems around undesirable characteristics like heterogeneous individual growth rate. This is not domestication.

Domestication seeks to change, not tolerate, undesirable performances. Of course, during the formative years of the development of a *Macrobrachium rosenbergii* industry in Hawaii (and elsewhere) the natural biological patterns of the organism had to be accommodated. But culture technology has progressed sufficiently so that intervention to change certain biological species characteristics is not only possible but necessary. Passively allowing *M. rosenbergii* to display natural, but unfavorable, patterns and/or adopt survival mechanisms in culture systems is extremely counterproductive. The time has come to “winnow” *M. rosenbergii*’s gene pool now that it has been successfully “flushed.”

THE FUTURE: CHANGING *M. ROSENBERGII*’S GENE POOL

In my opinion two approaches hold promise for winnowing the prawn’s gene pool: 1) sexual reversal and 2) hybridization. Both of these approaches can be brought to bear on the two most important characteristics of the prawn’s growth pattern: Sexually dimorphic growth and heterogeneous individual growth.

Sex Reversal

Sexually dimorphic growth could be manipulated by the generation of single sex broodstock. This could be accomplished by a mechanism shown in Figure 17. All females should result from such a mating as shown in Figure 17. If males are heterogametic, XY, generation of all male progeny by means of mating is more difficult since a feminized male mated to a normal male would give three possible genetic combinations. It is not known whether the YY genotypes would be viable; they are not in higher organisms. Even if they were, the YY condition would have to be identified without killing the animal and the mating and spawning of a normal female and a “virialized” female. Virialization of females and sexually indifferent prawns has been accomplished to a point in *Macrobrachium rosenbergii* (Nagamine 1979). It is possible that future work may be able to virilize genetic females such that they are reproductively capable of mating with a normal female.

Another route to take may be the affect of hormones on sexual development. Perhaps androgens and estrogens can be used to reverse sex as has been done in some fishes (Johnstone et al. 1978; Yamazaki 1976).

All of this is very speculative and the effective incorporation of sex reversal in monosex prawn culture will require a lot of work. Despite this, sex reversal holds promise for removing a major biological constraint in prawn culture.

Hybridization

In my opinion hybridization may hold high potential for genetically changing the heterogeneous individual growth pattern. If the latter is a species characteristic then hybrids between two species may exhibit a “hybrid breakdown” in the behavioral mechanisms which characterize their parental species. Of course this is only speculation at this point. There is no evidence that it will occur but I think it’s worth a try. Hybridization can also be useful for combining favorable genotypes such as from a species which gives good growth and one that is more cold tolerant and over-winters well.

Before one can proceed with successful hybridization, regardless of how productive it may be, one must first perfect methods of

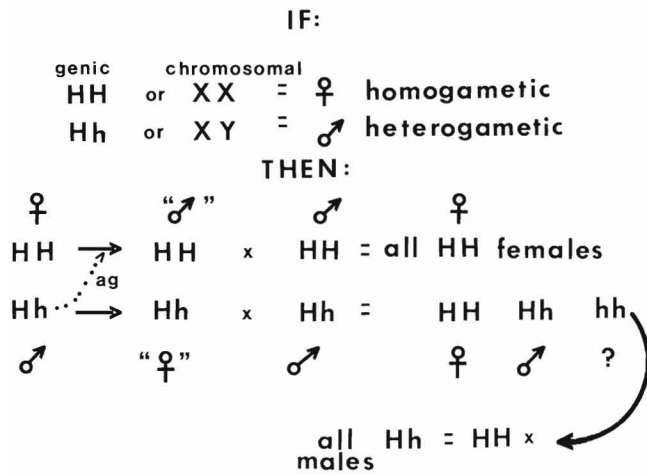

Figure 17.—Hypothetical scenario for the creation of monosex broods using sex reversal. Scenario is predicated upon a simple heterogametic/homogametic mechanism for sex determination, either a single diallelic locus or sex chromosome.

artificial insemination and in vitro development. Sandifer and his colleagues are conducting important studies in this area (Sandifer and Smith 1979; Sandifer and Lynn 1980).

ACKNOWLEDGMENTS

The assistance and professionalism of Jacqueline Glipa, Amy Dickson, and Scott Masuno in preparing, and working under the deadline for, this manuscript are gratefully appreciated.

Thanks also go to the following who kindly provided information for this review: Jim Boulet, Larose, La.; Robert Brick, Texas A&M University, College Station, Tex.; A. Farmanfarmanian, Rutgers University, N.J.; William Johnson and Kenan Smith, Oregon Institute of Technology, Klamath Falls, Oreg.; George Lewis, University of Georgia, College of Agriculture, Athens, Ga.; Peter Lutz, University of Miami, Miami, Fla.; Ed McSweeney, Weyerhaeuser Corporation, Homestead, Fla.; Paul Sandifer, South Carolina Wildlife & Marine Resources Department, Charleston, S.C.; Robert Taylor, University of Nevada, Reno, Nev.; Thomas Wellborn, Jr., Cooperative Extension Service, Mississippi State, Miss.; Jack Whetstone, Sea Grant Advisory Program, Clemson University, Georgetown, S.C.; and Ronald Wulff, Aqua Finca de Camerones, Honduras, C.A.

LITERATURE CITED

- BALON, E. K.
1974. Domestication of the carp, *Cyprinus carpio* L. R. Ont. Mus. Life. Sci. Misc. Publ., April 29, 1974.
- BARDACH, J. E., J. H. RYTHER, and W. O. McLARNEY.
1972. Aquaculture: The farming and husbandry of freshwater organisms. John Wiley & Sons, N.Y.
- BOYD, C. E.
1979. Water quality in warmwater fish ponds. Auburn Univ. Press, VII, 359 p.
- BRICK, R. W., and R. R. STICKNEY.
1979. Polyculture of *Tilapia aurea* and *Macrobrachium rosenbergii* in Texas. Proc. World Maricult. Soc. 10:222-228.

- CARSON, H. L.
1968. The population flush and its genetic consequences. In R. C. Lewontin (editor), Population biology and evolution, p. 123-137. Syracuse Univ. Press, Syracuse, N.Y.
1975. The genetics of speciation at the diploid level. Am. Nat. 109:83-92.
- COHEN, D., A. FINKEL, and M. SUSSMAN.
1976. On the role of algae in larviculture of *Macrobrachium rosenbergii*. Aquaculture 8:199-207.
- COWAN, W. F., and G. F. LEE.
1973. Leaves as a source of phosphorous. Environ. Sci. Technol. 7:853-854.
- DARNELL, R. M.
1964. Organic detritus in relation to secondary production in aquatic communities. Int. Ver. Theor. Agnew. Limnol. Verh. 15:462-470.
- DICKENSON, C. H., and G. F. F. FUGH.
1974. Biology of plant litter decomposition. Vols. I, II. Acad. Press, N.Y.
- DOYLE, R. W., and W. HUNTE.
1981. Genetic changes in "fitness" and yield of a crustacean population in a controlled environment. J. Exp. Mar. Biol. Ecol. 52:147-156.
- DUGAN, C. C., R. W. HAGOOD, and T. A. FRANKS.
1975. Development of spawning and mass larval rearing techniques for brackish-freshwater shrimps of the genus *Macrobrachium* (Decapoda palaemonidae). Fla. Mar. Res. Publ. 12, 28 p.
- EBLE, A. F., M. C. EVANS, N. DeBLOIS, and N. E. STOLPE.
1977. Maintenance of broodstock, larval rearing and nursery techniques used to grow *Macrobrachium rosenbergii* in waste-heat discharge waters of an electric generating station in New Jersey (U.S.A.). Actes de Colloques du C.N.E.X.O. 4:233-245.
- EBLE, A. F., N. E. STOLPE, M. C. EVANS, and N. F. DeBLOIS.
1975. The use of thermal effluents of an electric generating station in New Jersey in the culture of the tropical prawn, *Macrobrachium rosenbergii*, and the rainbow trout *Salmo gairdneri*. In C. R. Guerra, B. L. Godfriaux, and A. F. Eble (editors), Power plant waste heat utilization in aquaculture - Workshop I papers, p. 234. Public Serv. Elec. and Gas Co., Newark, N.J.
- FENCHEL, T. M., and B. B. JORGENSEN.
1977. Detritus foodchains of aquatic ecosystems. Adv. Microb. Ecol. 1:1-58.
- FLOODGATE, G. D.
1972. The mechanism of bacterial attachment to detritus in aquatic systems in detritus and its role in aquatic ecosystems. Mem. Inst. Ital. Idrobiol. 29(suppl.):105-127.
- FORSTER, J. R. M.
1972. Some methods of binding prawn diets and their effects on growth and assimilation. J. Cons. Int. Explor. Mer 34:200-216.
- FORSTER, J. R. M., and T. W. BEARD.
1974. Experiments to assess the suitability of nine species of prawns for intensive cultivation. Aquaculture 3:355-368.
- FRANKENBERG, D., and K. L. SMITH, Jr.
1967. Coprophagy in marine animals. Limnol. Oceanogr. 12:443-450.
- FUJIMURA, T.
1974. Development of a prawn culture industry in Hawaii. Job completion report: July 1, 1969 to June 30, 1972. U.S. Dep. Commer., NOAA, NMFS, 21 p.
- FUJIMURA, T., and H. OKAMOTO.
1972. Notes on progress made in developing a mass culturing technique for *Macrobrachium rosenbergii* in Hawaii. In T. V. R. Pillay (editor), Coastal aquaculture in the Indo-Pacific region, p. 313-327. Fishing News (Books) Ltd., Surrey, Engl.
- GODFRIAUX, B. L., C. R. GUERRA, and R. E. RESH.
1977. Venture analyses for intensive waste heat aquaculture. Proc. World Maricult. Soc. 8:707-722.
- GOODWIN, H.
1977. Of prawns, people, and soy sauce. In J. A. Hanson and H. L. Goodwin (editors), Shrimp and prawn farming in the Western Hemisphere, p. 197-200. Dowden, Hutchinson & Ross, Inc., Stroudsburg, Pa.
- HAGOOD, R. W., and S. A. WILLIS.
1976. Cost comparisons of rearing larvae of freshwater shrimp, *Macrobrachium acanthurus* and *M. rosenbergii*, to juveniles. Aquaculture 7:55-74.
- HALE, E. B.
1962. Domestication and the evolution of behavior. In E. S. E. Hafez (editor), The behavior of domestic animals. Baillière Tindall & Cox, Lond.
- HALL, K. J.
1975. Effect of nutrient enrichment on the heterotrophic uptake of organic solutes by micro-organisms. Verh. Int. Verein. Limnol. 19:280-285.
- HANSON, J. A., and H. L. GOODWIN.
1977. Shrimp and prawn farming in the Western Hemisphere. Dowden, Hutchinson & Ross, Inc., Stroudsburg, Pa., 439 p.

- HARGRAVE, B. T.
1972. Aerobic decomposition of sediment and detritus as a function of particle surface area and organic content. *Limnol. Oceanogr.* 17:583-596.
- HEDGECOCK, D., D. J. STELMACH, K. NELSON, M. E. LINDENFELSER, and S. R. MALECHA.
1979. Genetic divergence and biogeography of natural populations of *Macrobrachium rosenbergii*. *Proc. World Maricult. Soc.* 10:873-879.
- HINES, N. O.
1976. Fish of rare breeding: salmon and trout of the Donaldsen strains. *Smithson. Inst. Press, Washington, D.C.*, 167 p.
- HOLTHUIS, L. B.
1950. The Palaemonidae collected by the Siboga and Snellius expeditions with remarks on the other species I. Subfamily Palaemonidae. *Siboga Exped.* 141, 268 p.
1952. A general revision of the Palaemonidae (Crustacea Decapoda Natantia) of the Americas. II. The Subfamily Palaemonidae. *Allan Hancock Found. Publ., Occas. Pap.* 12:1-132.
- HUNER, J. V., W. G. PERRY, M. MILTNER, R. A. BEAN, and J. W. AVAULT.
1980. Preliminary studies into the polyculture of giant Malaysian prawns, *Macrobrachium rosenbergii*, and channel catfish fingerlings, *Ictalurus punctatus*, in Louisiana. *Res. Workshop Catfish Farmers of America, Annu. Convention, New Orleans, Louisiana, March 6-8, 1980.*
- IVERSON, T. M.
1973. Decomposition of autumn-shed beech leaves in a spring-brook and its significance for the fauna. *Arch. Hydrobiol.* 72:305-312.
- IVLEV, V. S.
1966. The biological productivity of waters. *J. Fish. Res. Board Can.* 23:1727-1759.
- JOHANNES, R. E., and M. SATOMI.
1966. Composition and nutritive value of fecal pellets of a marine crustacean. *Limnol. Oceanogr.* 11:191-197.
- JOHNSON, D. S.
1960a. Some aspects of the distribution of freshwater organisms in the Indo-Pacific area, and their relevance to the validity of the concept of an oriental region in zoogeography. *Proc. Cent. Bicent. Congr. Biol. Singapore, 1958*, p. 170-181.
1960b. Sub-specific and intra-specific variation in some freshwater prawns of the Indo-Pacific region. *Proc. Cent. Bicent. Congr. Biol. Singapore, University of Malaya Press.*
- JOHNSTONE, R., T. H. SIMPSON, and A. F. YOUNGSON.
1978. Sex reversal in salmonid culture. *Aquaculture* 13:115-134.
- KNEALE, D., and J. K. WANG.
1979. A laboratory investigation of *Macrobrachium rosenbergii* nursery production. *Proc. World Maricult. Soc.* 10:359-368.
- LEE, S. R.
1979. The Hawaiian prawn industry: a profile. *Aquaculture Development Program, Department of Planning and Economic Development, State of Hawaii*, 32 p.
- LING, S. W.
1969a. The general biology and development of *Macrobrachium rosenbergii* (de Man). *FAO Fish. Rep.* 57:589-606.
1969b. Methods of rearing and culturing *Macrobrachium rosenbergii* (De Man). *FAO Fish. Rep.* 57:607-619.
- LING, S. W., and T. J. COSTELLO.
1976. The culture of freshwater prawns: A review. *In* T. V. R. Pillay and W. A. Dill (editors), *Advances in aquaculture*. Fishing News (Books) Ltd., Lond.
- LOCK, M. A., and H. B. N. HYNES.
1976. The fate of "dissolved" organic carbon derived from autumn-shed maple leaves (*Acer saccharum*) in a temperate hard-water stream. *Limnol. Oceanogr.* 21:436-443.
- LUSH, D. L., and H. B. N. HYNES.
1973. The formation of particles in freshwater leachates of dead leaves. *Limnol. Oceanogr.* 18:968-977.
- MALECHA, S. R.
1977. Genetics and selective breeding of *M. rosenbergii*. *In* J. A. Hanson and H. L. Goodwin (editors), *Shrimp and prawn farming in the Western Hemisphere*, p. 328-355. Dowden, Hutchinson & Ross, Inc., Stroudsburg, Pa.
1981. Polyculture of the freshwater prawn, *Macrobrachium rosenbergii*, Chinese and common carps in ponds enriched with swine manure I. Initial traits. *Aquaculture* 25:101-116.
- MALECHA, S. R., J. POLOVINA, and R. MOAV.
1981. Multi-stage rotational stocking and harvesting system for year-round culture of the freshwater prawn, *Macrobrachium rosenbergii*. *Univ. Hawaii Sea Grant Tech. Rep. UNIHI-SG-TR-81-01*, 33 p.
- MALECHA, S. R., D. SARVER, and D. R. ONIZUKA.
1980. Approaches to the study of domestication in the freshwater prawn, *Macrobrachium rosenbergii*, with special emphasis on the Anuenue and Malaysian stocks. *Proc. World Maricult. Soc.* 11:500-528.
- MANCEBO, V. J.
1978. Growth in tank-reared populations of the Malaysian prawn, *Macrobrachium rosenbergii* (de Man). *Proc. World Maricult. Soc.* 9:83-90.
- McCAULEY, D. E.
1978. Demographic and genetic responses of two strains of *Tribolium castaneum* to a novel environment. *Evolution* 32:398-415.
- MIYAJIMA, L. S.
1977. About *Macrobrachium* species. *In* J. A. Hanson and H. L. Goodwin (editors), *Shrimp and prawn farming in the Western Hemisphere*, p. 201-209. Dowden, Hutchinson & Ross, Inc., Stroudsburg, Pa.
- MOAV, R., G. HULATA, and G. WOHLFARTH.
1975. Genetic differences between the Chinese and European races of the common carp: I. analysis of genotype-environment interactions. *Heredity* 34:323-340.
- MOAV, R., and G. W. WOHLFARTH.
1973. Carp breeding in Israel. *In* R. Moav (editor), *Agricultural genetics, selected topics*, p. 295-318. John Wiley & Sons, Inc., N.Y.
1974. Magnification through competition of genetic differences in yield capacity in carp. *Heredity* 33:181-202.
- MOAV, R., G. WOHLFARTH, G. L. SCHROEDER, G. HULATTA, and H. BARASH.
1977. Intensive polyculture of fish in freshwater ponds. I. Substitution of expensive feeds by liquid cow manure. *Aquaculture* 10:25-43.
- MORTON, N. E., C. S. CHUNG, and M. MI.
1967. Genetics of interracial crosses in Hawaii. *Monogr. Hum. Genet., Vol. 3*, 158 p. S. Karger A.G., N.Y.
- NAGAMINE, C. M.
1979. The development of sexual dimorphism in the Malaysian prawn, *Macrobrachium rosenbergii* (De Man), and the effects on the primary and secondary sexual characteristics following androgenic gland ablation in the male and androgenic implantation in the female. *Ph.D. Thesis, Univ. California, Davis*, 140 p.
- NAKAMURA, N., and S. KASAHARA.
1955. A study on the phenomenon on the Tobi-koi or shoot carp.-I. On the earliest stage at which the shoot carp appears. [*In Jpn.*] *Bull. Jpn. Soc. Sci. Fish.* 21:73-76. Translated in *Bamidgeh* 29:41-44.
1957. A study on the phenomenon of the Tobi-koi or shoot carp.-III. On the result of culturing the modal group and the growth of carp fry reared individually. [*In Jpn.*] *Bull. Jpn. Soc. Sci. Fish.* 22:674-678. Translated in *Bamidgeh* 29:48-52.
- NEI, M.
1972. Genetic distance between populations. *Am. Nat.* 106:283-292.
- ODUM, E. P., and A. A. de la CRUZ.
1963. Detritus as a major component of ecosystems. *Bull. Am. Inst. Biol. Sci.* 13:39-40.
1967. Particulate organic detritus in a Georgia salt marsh-estuarine ecosystem. *In* E. M. Lauff (editor), *Estuaries*, p. 383-389. AAAS Publ., Washington, D.C.
- OLAH, J.
1972. Leaching, colonization and stabilization during detritus formation in detritus and its role in aquatic ecosystems. *Mem. Inst. Ital. Idrobiol.* 29(suppl.):105-127.
- PAERL, H. W.
1974. Bacterial uptake of dissolved organic matter in relation to detrital aggregation in marine and freshwater systems. *Limnol. Oceanogr.* 19:966-972.
1978. Microbial organic carbon recovery in aquatic ecosystems. *Limnol. Oceanogr.* 23:927-935.
- PATWARDHAN, S. S.
1935a. On the structure and mechanism of the gastric mill in Decapoda. V. The structure of the gastric mill in *Natantous macrura*—Caridea. *Proc. Ind. Acad. Sci. B*, 1:693-704.
1935b. On the structure and mechanism of the gastric mill in Decapoda. VI. The structure of the gastric mill in *Natantous macrura*—Penaeidea and Stenopidea; Conclusion. *Proc. Ind. Acad. Sci. B*, 2:155-174.
- RAO, R. M.
1965. Breeding behavior in *Macrobrachium rosenbergii* (de Man). *Fish Technol., India* 2(1):19-25.
- RICKER, W. E.
1958. Handbook of computations for biological statistics of fish populations. *Fish. Res. Board Can., Bull.* 119, 300 p.
- ROBERTS, K. J., and L. L. BAUER.
1978. Costs and returns for *Macrobrachium* grow-out in South Carolina,

- U.S.A. *Aquaculture* 15:383-390.
- SANDIFER, P. A., J. S. HOPKINS, and T. I. J. SMITH.
1977. Production of juveniles. In J. A. Hanson and H. L. Goodwin (editors), *Shrimp and prawn farming in the Western Hemisphere*, p. 220-231. Dowden, Hutchinson & Ross, Inc., Stroudsburg, Pa.
- SANDIFER, P. A., and J. W. LYNN.
1980. Artificial insemination of caridean shrimp. In W. H. Clark and T. S. Adams (editors), *Advances in invertebrate reproduction*, p. 271-288. Elsevier Press, N.Y.
- SANDIFER, P. A., and T. I. J. SMITH.
1975. Effects of population density on growth and survival of *Macrobrachium rosenbergii* reared in recirculating water management systems. *Proc. World Maricult. Soc.* 6:43-53.
1977. Intensive rearing of post larval Malaysian prawns (*Macrobrachium rosenbergii*) in a closed cycle nursery system. *Proc. World Maricult. Soc.* 8:225-244.
1978. Aquaculture of Malaysian prawns in controlled environments. *Food Technol.* 32(7):36-45, 83.
1979. A method for artificial insemination of *Macrobrachium* prawns and its potential use in inheritance and hybridization studies. *Proc. World Maricult. Soc.* 10:403-418.
- SARVER, D., S. MALECHA, and D. ONIZUKA.
1979. Development and characterization of genetic stocks and their hybrids in *Macrobrachium rosenbergii*: physiological responses and larval development rates. *Proc. World Maricult. Soc.* 10:880-892.
- SHANG, Y. C., and T. FUJIMURA.
1977. The production economics of freshwater prawn (*Macrobrachium rosenbergii*) farming in Hawaii. *Aquaculture* 11:99-110.
- SMITH, T. I. J., and P. A. SANDIFER.
1975. Increased production of tank-reared *Macrobrachium rosenbergii* through use of artificial substrates. *Proc. World Maricult. Soc.* 6:55-66.
1980. Influence of three stocking strategies on the production of prawns, *Macrobrachium rosenbergii*, from ponds in South Carolina, U.S.A. Symposium on Coastal Aquaculture, Cochin, India, Jan. 12-18, 1980. *Mar. Biol. Assoc., India*.
- SMITH, T. I. J., P. A. SANDIFER, W. E. JENKINS, and A. D. STOKES.
1981. Effect of population structure and density at stocking on production and commercial feasibility of prawn (*Macrobrachium rosenbergii*) farming in temperate climates. *Proc. World Maricult. Soc.* 12:233-250.
- SMITH, T. I. J., P. A. SANDIFER, and M. H. SMITH.
1978. Population structure of Malaysian prawns, *Macrobrachium rosenbergii* (de Man), reared in earthen ponds in South Carolina, 1974-1976. *Proc. World Maricult. Soc.* 9:21-38.
- SMITH, T. I. J., P. A. SANDIFER, and W. C. TRIMBLE.
1976. Pond culture of the Malaysian prawn, *Macrobrachium rosenbergii* (de Man), in South Carolina. *Proc. World Maricult. Soc.* 7:625-645.
- SOLLER, M., and R. MOAV.
1973. Broiler breeding. Practice and perspectives. In R. Moav (editor), *Agricultural genetics, selected topics*, p. 275-293. John Wiley & Sons, N.Y.
- SPURWAY, H.
1955. The causes of domestication: an attempt to integrate some ideas of Konrad Lorenz with evolution theory. *J. Genet.* 53:325-362.
- STELMACH, D.
1980. Electrophoretic variation in *M. rosenbergii*: evidence for subspecific variation. M.S. Thesis, Univ. Hawaii, Honolulu, 36 p.
- TRACEY, M. L., K. NELSON, D. HEDGECOCK, R. A. SHLESER, and M. L. PRESSICK.
1975. Biochemical genetics of lobsters: genetic variation and the structure of American lobster (*Homarus americanus*) populations. *J. Fish. Res. Board Can.* 32:2091-2101.
- TURNER, R. E.
1978. Community plankton respiration in a salt marsh estuary and the importance of macrophytic leachates. *Limnol. Oceanogr.* 23:442-451.
- WICKENS, J. F.
1976. Prawn biology and culture. *Oceanogr. Mar. Biol. Annu. Rev.* 14:435-507.
- WICKENS, J. F., and T. W. BEARD.
1974. Observations on the breeding and growth of the giant freshwater prawn *Macrobrachium rosenbergii* (De Man) in the laboratory. *Aquaculture* 3:159-174.
- WILLIS, S. A.
1978. Effects of fertilization and selective harvest on pond culture of *Macrobrachium rosenbergii* in Central Florida. Completion Report, U.S. Dep. Commer., NOAA, NMFS, PL88-309, No. 2-298-R-1, Job 3B.
- WILLIS, S. A., and M. E. BERRIGAN.
1977. Effects of stocking size and density on growth and survival of *Macrobrachium rosenbergii* (De Man) in ponds. *Proc. World Maricult. Soc.* 8:251-264.
- WILLIS, S. A., R. W. HAGOOD, and G. T. ELIASON.
1976. Effects of four stocking densities and three diets on growth and survival of post larval *Macrobrachium rosenbergii* and *M. acanthurus*. *Proc. World Maricult. Soc.* 7:655-665.
- WOHLFARTH, G. W., and R. MOAV.
1972. The regression of weight gain on initial weight in carp. I. Methods and results. *Aquaculture* 1:7-28.
- WOHLFARTH, G., R. MOAV, and G. HULATA.
1975. Genetic differences between the Chinese and European races of the common carp. II. Multi-character variation—a response to the diverse methods of fish cultivation in Europe and China. *Heredity* 34:341-350.
- WRIGHT, S.
1963. Genic interaction. In W. J. Burdette (editor), *Methodology in mammalian genetics*, p. 159-192. Holden-Day, San Francisco, Calif.
- YAMAZAKI, F.
1976. Application of hormones in fish culture. *J. Fish. Res. Board Can.* 33:948-958.
- ZEUNER, F. E.
1963. A history of domesticated animals. Hutchinson, Lond., 560 p.

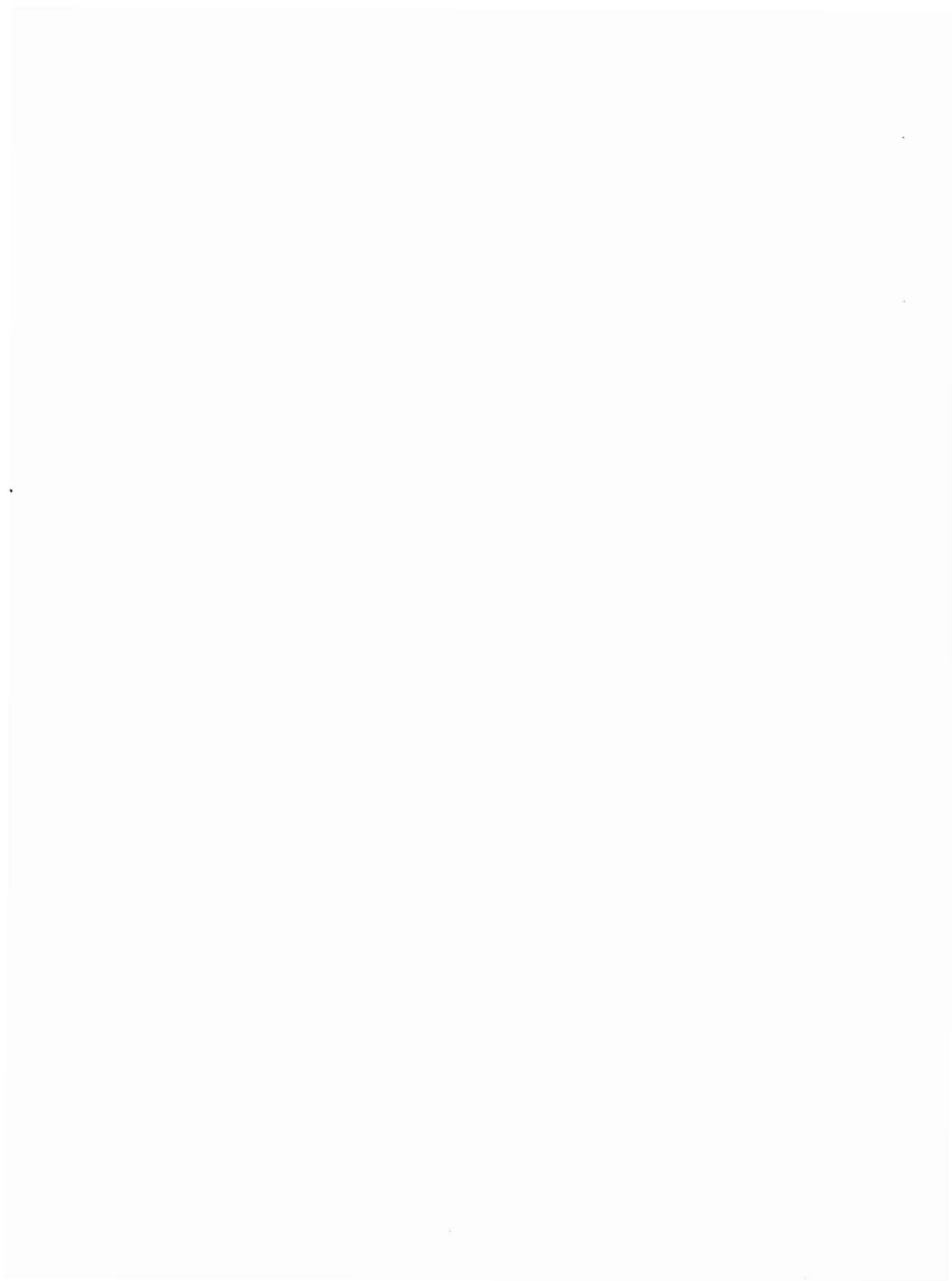

Research and Development in Maturation and Production of Penaeid Shrimp in the Western Hemisphere

ROBERT A. SHLESER and L. FRANK FOLLETT¹

INTRODUCTION

Marine shrimp occupy the largest section of the U.S. seafood market. In terms of product value, in 1977, almost 25% of the seafood market in the United States was occupied by marine shrimp (Robinson 1977). Approximately 1.6 million pounds of shrimp are consumed in the United States each day, 70% of this amount imported from outside our country. This totals more than \$490 million worth of imported shrimp per year.

The ability of our domestic shrimp fleet to continue to supply current levels of this product is now in question. The recently established 200-mi economic zone has resulted in the exclusion of U.S. boats from many regions where they previously had access to fertile areas for catching shrimp. With the increased recognition of the value of shrimp, it is likely that in the near future U.S. boats may also be excluded from other regions where U.S. fishing rights had previously been established.

The shrimp fishery within the United States' own 200-mi zone is limited, so foreign restriction of the fishery is expected to place increased pressure on other stocks available in unrestricted international waters. This will have a "domino effect" of requiring larger vessels to cover greater distances, in order to sustain the amount of catch that is needed to keep up with boat loan payments, insurance, and other related costs. In turn, the increased fishing pressure will require more fuel, which will significantly affect the cost of fishing and ultimately make the U.S. catch less competitive with foreign products from areas such as Ecuador, where petroleum fuel is still 18¢ per gallon.

Though it is too soon to reach a conclusion, there is also speculation that oil spills in the Gulf of Mexico may have an adverse impact on our domestic shrimp catch. Finally, the availability of the catch to the U.S. market may be confounded by the fact that other nations which value shrimp more than the United States can compete economically for the amount of product available when supplies are limited.

While the prognosis for the shrimp fishery appears poor, especially for the United States, the demand for shrimp is increasing. We feel that a shrimp aquaculture industry in the United States could help supply our domestic demand for the product, and have other advantages such as providing new economic opportunities for rural communities.

PRELIMINARY WORK AND COMMERCIAL PRODUCTION

Until recently, shrimp farming has been restricted to regions of the world where gravid females of suitable species have been available in abundance. Failure to achieve mastery over reproduc-

tion of penaeid shrimp has restricted shrimp aquaculture from expanding to new areas which have acceptable climatic and seawater conditions, but which lack suitable indigenous species. Until recently, such areas as Honduras, Panama, Ecuador, and Costa Rica have seen expansion of shrimp farming. An important pioneer in this area has been the Ralston Purina² Company, which has an extensive development of shrimp farms in Panama. Ralston Purina plans to complete 1,600 acres of new shrimp production ponds before the end of 1980. In addition, Table 1 shows our estimates of commercial shrimp ponds currently in production in the Western Hemisphere.

It may provide a useful perspective to present a short review of the development of current shrimp farming techniques in Central and South America. As mentioned above, the Ralston Purina Company is responsible for most of the early pioneering work in the industry, having refined the techniques for shrimp larval culture which were developed by Mock of the National Marine Fisheries Service Laboratory in Galveston, Tex. Additional information from experimental fishing documented the locations where gravid females could be found in abundance throughout the year. Using this information, industry is able to capture females and spawn them aboard the fishing vessels. The resultant larvae are then reared in culture tanks until they are 10 d beyond the postlarval stage, with survival rates currently as high as 80%. The shrimp are then grown in nursery ponds until they reach 1 g size; feed conversion at this stage is 1.0:1 to 1.2:1. Nurseries measuring up to 2 acres have been successfully managed. The shrimp are then stocked at a density of 30,000 to 40,000/acre in large grow-out ponds which measure 10 to 50 acres in size. At this stage, feed conversion rates of 2.75:1 are the average, with feeds of about 25% protein, costing 12¢ to 15¢/lb in Central America. The shrimp are harvested after approximately 120 d in the pond. With a survival rate of 60%, and depending on season, it is possible to

²Reference to trade names does not imply endorsement by the National Marine Fisheries Service, NOAA.

Table 1.—Estimated acreage of commercial shrimp production ponds in the Western Hemisphere.

Country	Acres
Brazil	1,000
Colombia	80
Costa Rica	400
Ecuador	60,000
Honduras	220
Panama	1,800
Peru	100
United States	680

¹The Oceanic Institute, Makapuu Point, Waimanalo, HI 96795.

obtain about 1,400 lb/acre per crop. Shrimp tails of a size which total between 30 to 40/lb are produced.

At the Oceanic Institute, we are evaluating the economic and technical potential of farming marine shrimp in Hawaii. We are conducting evaluations of four species of marine shrimp: *Penaeus vannamei* and *Penaeus stylirostris* from Central and South America, *Penaeus monodon* from Southeast Asia, and *Penaeus japonicus* from Japan.

As part of this work, we have performed an economic analysis of the costs of production in Hawaii (Shleser 1979). In order to understand the potential of shrimp farming, we designed a conceptual 100-acre shrimp farm with facilities for a hatchery, a nursery with 5 0.25-acre ponds, a grow-out capacity of 15 5-acre ponds, and 3 0.25-acre ponds where shrimp are matured for breeding purposes (Fig. 1, Table 2).

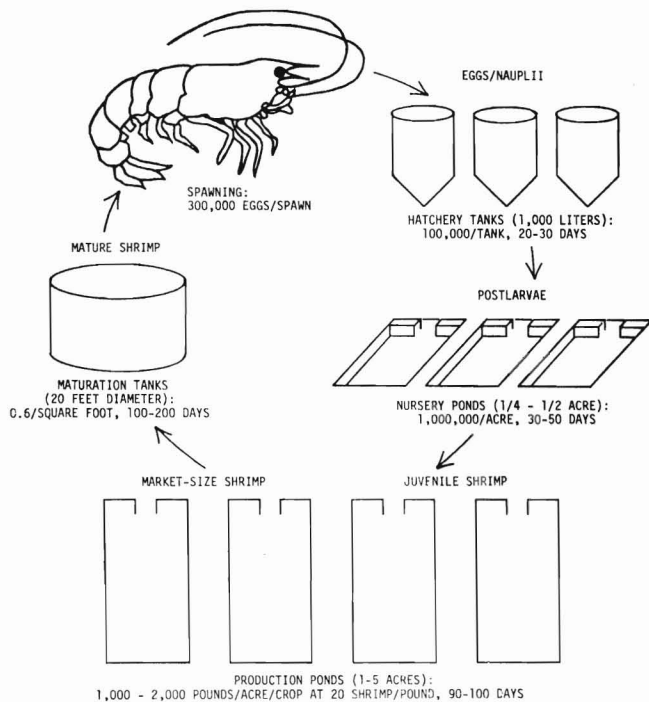

Figure 1.—Steps in the shrimp production cycle.

Table 2.—Summary of annual operating costs for a 100-acre shrimp farm in Hawaii.

Item	Amount	Percent
Hatchery and brood stock operating costs	\$ 72,825	11
Amortization of capital costs (10 yr at 17% interest)	147,450	23
Taxes	9,600	1
Salaries	93,150	15
Security	1,000	0
Feed	225,475	35
Operating supplies	10,000	1
Utilities	12,184	2
Mileage	5,200	1
Legal and auditing services	6,500	1
Contingent costs (10% of total costs)	58,338	10
Total	\$641,722	100

The completed economic analysis revealed several interesting points which have played a major role in shaping our research at the Oceanic Institute:

- 1) At present market prices, shrimp farming in Hawaii could be carried out profitably if suitable species were available, and if shrimp could be bred in Hawaii.
- 2) The major cost in shrimp production is feed.
- 3) Increasing the number of pounds produced annually by increasing production or growth rate is the only significant improvement to be made on the economics of production, besides reducing feed costs.

Of major interest has been the possibility of reducing feed costs by using cow manure to enrich ponds and establish food chains that will help sustain the shrimp. Preliminary observations were made several years ago at the Oceanic Institute, which encouraged us to conduct more formal experiments. We received 25,000 *Penaeus japonicus* postlarvae from Jiro Kittaka of Kitasato University in Japan, grew the shrimp to 0.25 g size in round tanks, then stocked them in an 1/8-acre, mud-bottom pond which had been enriched with sun-dried cow manure. The shrimp were fed approximately 1% body weight per day of a commercial feed containing 25% protein. After 6 wk, the pond was harvested. The average weight of the shrimp was 17.2 g, with some shrimp weighing as much as 30 g (Fig. 2). We are currently conducting an extensive program to further evaluate the use of cow manure as a means of reducing production costs in shrimp farming. We are evaluating water quality, pond biota, microbiology, nutrition, stocking density, maturation rate, and economics.

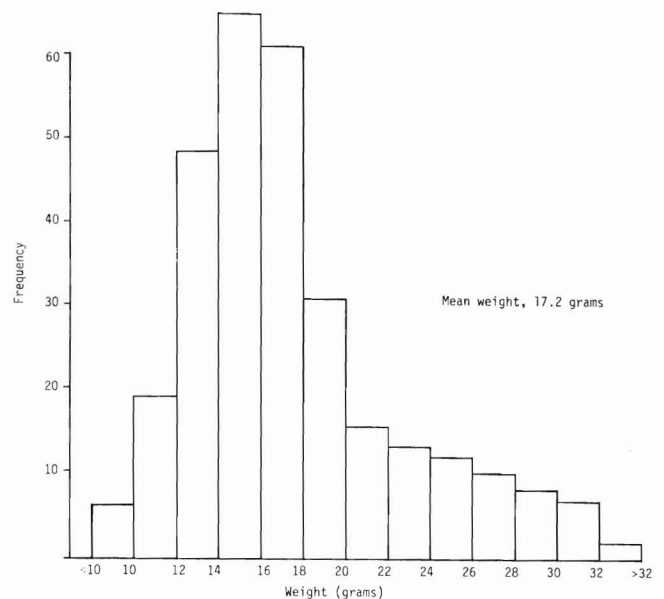

Figure 2.—Frequency distribution of weights of 298 *Penaeus japonicus* harvested from P-1, 2 (JP-1), 21 September 1978.

MATURATION WORK

As mentioned previously, until recently shrimp farming has been restricted to regions with natural populations of a suitable species of shrimp. Hawaii has no species of indigenous shrimp that are known to be suitable for aquaculture, so if an industry is

to develop there, it will be essential to mature and spawn shrimp in captivity. Thus, maturation and spawning are areas of great interest to us, as well as to other researchers around the world who are involved in shrimp aquaculture. The Oceanic Institute is relatively new in this field. Considerable work had been done by others before the Oceanic Institute entered the field. This previous work provides the basis for the development of our programs.

Induced Maturation

Following the rediscovery of the Panhouse effect, recent research in Tahiti and the Philippines has shown that penaeid shrimp can be induced to mature, mate, and produce offspring in captivity (Panhouse 1943). This has been accomplished by pinching off one eyestalk (ablation) of female shrimp grown to mature size in captivity or obtained from the wild. Male shrimp appear to mature normally in captivity, and achieve reproductive capability without such treatment. Such ablation studies have been repeated in other parts of the world, and eight shrimp species are now known to respond to this technique. These species are: *Penaeus monodon*, *P. aztecus*, *P. setiferus*, *P. stylirostris*, *P. merguensis*, *P. japonicus*, *P. vannamei*, and *Metapenaeus ensis* (Aquacop 1979; Caubère et al. 1976; Laubier-Bonichon and Laubier 1976; McGrath;³ Primavera 1978a, b).

The success of the ablation technique in stimulating reproduction in penaeid shrimp is consistent with postulated mechanisms of reproductive control in other crustaceans (Adiyodi and Adiyodi 1970; Bliss 1966; Bomirski and Klek 1974; Cheung 1966, 1969; Fyffe and O'Connor 1974; Gomez 1965; Kleinholz 1976; Klek-Kawinska and Bomirski 1975; Otsu 1963). It is suggested that the sequence of reproductive processes (gonad maturation, egg development, formation and release of mating hormone to initiate mating behavior, and spawning) is blocked by the presence of an inhibiting hormone which is synthesized in the eyestalks. Ablation reduces the concentration of inhibitory hormone circulating within the shrimp's body. When the titer of inhibitory hormone is low, the thoracic ganglion or brain produces and releases a gonad-stimulating hormone which begins the reproductive sequence described above.

The results achieved with the ablation technique are considered a major breakthrough in penaeid shrimp aquaculture. However, attempts to apply the technique as a practical means of providing the numbers of offspring required to stock large commercial shrimp farms have not proven totally satisfactory. In some instances, ablated female shrimp showed mating behavior but failed to spawn. The numbers of eggs spawned were often considerably fewer than those from wild-caught spawners. Hatching rates were frequently low, and at times the hatched larvae did not survive the larval period (MacGrath footnote 3; Simon⁴; Yap⁵).

Such observations suggest that eyestalk ablation prior to the completion of other essential events such as yolk development or DNA formation disrupts the timing and sequence required for successful reproduction. This comes as no surprise, since reviews by Kleinholz and Adiyodi and Adiyodi describe numerous other endocrine functions found in the eyestalk (Adiyodi and Adiyodi 1970; Kleinholz 1976). Eyestalk ablation therefore removes not

only the source of the gonad-inhibiting hormone, but also the source of a number of other metabolic hormones which may play an important part in reproduction. These results and possibilities emphasize the need for a more basic understanding of both the factors and mechanisms that control reproduction, as well as the processes involved in formation and maturation of eggs in the ovary.

Continuing research has just begun to be effective in solving some of these problems. Emphasis has been placed on nutrition, using live or freshly killed "natural foods," and on fortuitous sets of physical rearing conditions (MacGrath footnote 3; Yap footnote 5), since studies over the past 20 yr have verified that nutrition, salinity, temperature, and photoperiod affect reproduction (Caubère et al. 1976; Cheung 1969; Giese 1959; Laubier-Bonichon and Laubier 1976).

Three present research programs at Texas A&M University are relevant to this approach. Addison Lawrence is currently investigating the relationship between the process of reproduction and the concentration of protein, lipid, and carbohydrate in major tissues (such as the hepatopancreas, gonads, and muscles) in comparisons between wild-caught shrimp and those cultivated under various environmental conditions. Robert Brick pursues a similar approach with the histology and histochemistry of these organs. Brian Middleditch focuses on determining dietary deficiencies by examining the lipid components of various tissues and of eggs from wild stock, compared with patterns obtained from shrimp reared in captivity.

Related studies are also in progress at the Environmental Research Laboratory of the University of Arizona, and by Aquacop⁶ at the CNEXO Laboratory in Tahiti, where changes in dietary components are being evaluated with respect to reproduction. The Galveston Laboratory of the National Marine Fisheries Service has made great progress in this area using the ablation technique. They have been spawning several females per week of the species *Penaeus stylirostris*, using a modification of the technique developed by the Aquacop group in Tahiti.

Natural Maturation

To date, not enough information has been accumulated to completely elucidate all of the factors responsible for stimulating reproductive behavior for any one penaeid species. However, a number of groups have periodically succeeded in achieving maturation and spawning of nonablated female shrimp. The Aquacop group in Tahiti has succeeded in spawning *Penaeus vannamei*, *P. stylirostris*, *P. monodon*, *P. japonicus*, *P. merguensis*, and *Metapenaeus ensis* without ablation (Aquacop 1979). The Ralston Purina Company, at its experimental facility in Florida and its production facility in Panama, has succeeded in spawning *P. vannamei* and *P. stylirostris* without ablation. *Penaeus japonicus* has been spawned in France by Laubier-Bonichon and Laubier (1976).

The Oceanic Institute has achieved natural reproduction of *Penaeus japonicus* in Hawaii. We held approximately 50 *P. japonicus* in a 7.3 m diameter pool, designed according to the system devised by Shigueno (1975). The shrimp were fed at approximately 5% body weight per day using a mixture of freshly thawed lobster, oysters, clams, and squid, which were minced to a

³W. MacGrath, Director of Mariculture, Ralston Purina Company, St. Louis, Mo., pers. commun.

⁴C. M. Simon, Laboratory Supervisor, Maricultura, S.A., Puntarenas, Costa Rica, pers. commun.

⁵W. Yap, Aquaculture Research Coordinator, Southeast Asian Fisheries Development Centre (SEAFDEC), Iloilo, Philippines, pers. commun.

⁶Aquacop is the aquaculture team of the Centre Oceanologique du Pacifique. Located in Tahiti, the Centre is part of the French Centre National pour l'Exploitation des Océans (CNEXO).

particle size of about 1 cm². During January 1979, 10 females in the tank were observed to carry spermatophores. Nauplii were observed in the tank, but no attempt was made to rear the larvae at that time.

FUTURE WORK

It is clear that much work remains to be done in shrimp culture research. To this end, the National Marine Fisheries Service Laboratory at Galveston, Tex.; the Port Aransas Laboratory of Texas A&M University; and the Oceanic Institute have developed a collaborative program. James McVey of the Galveston Laboratory is researching environmental factors that control reproduction, while Addison Lawrence of Texas A&M University is investigating nutritional factors affecting reproduction. The Oceanic Institute is working in conjunction with Lewis Kleinholz of Reed College in Portland, Oreg., to identify and isolate the hormones controlling reproduction in penaeid shrimp.

LITERATURE CITED

- ADITYODI, K. G., and R. G. ADITYODI.
1970. Endocrine control of reproduction in decapod crustacea. *Biol. Rev.* 45:121-165.
- AQUACOP.
1979. Penaeid reared broodstock: closing the cycle of *P. monodon*, *P. stylirostris* and *P. vannamei*. *Proc. World Maricult. Soc.* 10:445-452.
- BLISS, D. E.
1966. Neurosecretion of invertebrates other than insects. Part IV. Physiological processes and neurosecretion as related to ecdysis and reproduction. Introduction: Relation between reproduction and growth in decapod crustaceans. *Am. Zool.* 6:231-233.
- BOMIRSKI, A., and E. KLEK.
1974. Action of eyestalks on the ovary in *Rithropanopeus harrisi* and *Cragnon cragnon* (Crustacea: Decapoda). *Mar. Biol. (Berl.)* 24:329-337.
- CAUBÈRE, J.-L., R. LAFON, F. RENÉ, and C. SALES.
1976. Etude de la maturation et la ponte chez *Penaeus japonicus* en captivité. In T. V. R. Pillay and W. A. Dill (editors), *Advances in aquaculture*, p. 277-284. FAO Tech. Conf. on Aquaculture, Kyoto, Japan.
- CHEUNG, T. S.
1966. The interrelations among three hormonal-controlled characters in the adult female shore crab, *Carcinus maenas* (L.). *Biol. Bull. (Woods Hole)* 130:59-66.
1969. The environmental and hormonal control of growth and reproduction in the adult female stone crab *Menippe mercenaria* (Say). *Biol. Bull. (Woods Hole)* 136:327-346.
- FYFFE, W. E., and J. D. O'CONNOR.
1974. Characterization and quantification of a crustacean lipovitellin. *Comp. Biochem. Physiol.* 47B:851-867.
- GIESE, A. C.
1959. Comparative physiology: Annual reproductive cycles of marine invertebrates. In V. E. Hall (editor), *Annual review of physiology*, Vol. 21, p. 547-576. Annual Reviews, Inc., Palo Alto, Calif.
- GOMEZ, R.
1965. Acceleration of development of gonads by implantation of brain in the crab *Paratelphusa hydrodromous*. *Naturwissenschaften* 52:216.
- KLEINHOLZ, L. H.
1976. Crustacean neurosecretory hormones and physiological specificity. *Am. Zool.* 16:151-166.
- KLEK-KAWINSKA, E., and A. BOMIRSKI.
1975. Ovary-inhibiting hormone activity in shrimp (*Cragnon cragnon*) eyestalks during the annual reproductive cycle. *Gen. Comp. Endocrinol.* 25:9-13.
- LAUBIER-BONICHON, A., and L. LAUBIER.
1976. Reproduction contrôlée chez la crevette *Penaeus japonicus*. In T. V. R. Pillay and W. A. Dill (editors), *Advances in aquaculture*, p. 273-277. FAO Tech. Conf. on Aquaculture, Kyoto, Japan.
- OTSU, T.
1963. Bihormonal control of sexual cycle in the fresh water crab, *Potamon dehaani*. *Embryologica* 8:1-20.
- PANHOUSE, J.
1943. Influence de l'ablation du pédoncule oculaire sur la croissance de l'ovaire chez la crevette *Leander serratus*. *C. R. Hebd. Seanc. Acad. Sci., Paris*, 217:553-555.
- PRIMAVERA, J. H.
1978a. Induced maturation and spawning in five-month-old *Penaeus monodon* Fabricius by eyestalk ablation. *Aquaculture* 13:355-359.
1978b. Annual Report. Aquaculture Department, Southeast Asian Fisheries Development Center (SEAFDEC), Iloilo, Philippines, 37 p.
- ROBINSON, L. A. (editor).
1977. Fisheries of the United States, 1976. U.S. Dep. Commer., NOAA, Natl. Mar. Fish. Serv., *Curr. Fish. Stat.* 7200, 96 p.
- SHIGUENO, K.
1975. Shrimp farming in Japan. Association for International Technical Promotion, Tokyo, Japan, 153 p.
- SHLESER, R.
1979. Economic analysis of shrimp farming in Hawaii. Working Report of the Oceanic Institute, Waimanalo, Hawaii.

An Invasive Fungus Disease of the Tanner Crab and its Aquacultural Connotations

ALBERT K. SPARKS¹

INTRODUCTION

The occurrence of an encrusting fungus on the exterior surface of the Tanner crab, *Chionoecetes bairdi*, has been recognized by fishermen, crab processors, and fishery biologists for many years. Because of the black pigmentation of the hyphae and fruiting bodies, it is known as "black mat disease" or "black mat syndrome." During the processing of crabs with the external encrustation, fragments of the pigmented fungus are frequently broken off and contaminate the meat. Therefore, crab processors are reluctant to buy heavily encrusted crabs and areas known to have a high prevalence of the condition are often avoided by fishermen.

The fungus was long thought to be restricted to the external surface of the crab. In the first published report of the syndrome, Van Hying and Scarborough (1973) identified the fungus as *Phoma fimeti*, a ubiquitous soil fungus, and stated that they never observed it in any internal tissues and that it apparently has no deleterious effect on the crab. They also noted that the fungus appears to be both species specific and area specific, not occurring on other crabs in localities of heavily infested *C. bairdi* or reported in the Pacific Northwest of the United States, Japan, or the Canadian Atlantic.

In the summer of 1978, J. Hibbits of my staff collected a number of *C. bairdi*, both with and without external encrustations, in the Kodiak area of Alaska. The crabs were necropsied aboard ship, with small random portions of each major organ excised and fixed for histological processing. On arrival at the laboratory in Mukilteo, Wash., the tissues were processed and examined microscopically.

Our initial studies (Sparks and Hibbits 1979) revealed that the fungus readily penetrates the exoskeleton, proliferates within the subepidermal tissues, and subsequently invades more internal tissues. We stated that heavy infections probably prevent molting and postulated that the disease is eventually fatal to the crab. We also questioned the identification of *P. fimeti* as the causative agent of the disease.

Through an arrangement with personnel of the Alaska Department of Fish and Game, I have continued the study with crabs shipped alive by air from Cordova, Alaska. To date (May 1980), I have thoroughly studied 50 crabs with external black mat encrustation and a like number without gross signs of the syndrome. I feel that I now have enough data to understand the progression, but not the rate, of internal infection. Mix and Sparks (1980) have also determined that the infection causes a statistically significant shift in the hemocyte differential count, with a marked increase in the percentage of eosinophilic granulocytes in infected crabs. Fur-

ther, the greater the number of internal organs infected, the more pronounced is the differential shift.

Careful study has shown that the fungus is an undescribed genus and species of Ascomycetes and a manuscript describing and naming it is in the final stages of preparation. It is an unusually fastidious fungus; numerous attempts to culture it from internal and external hyphae and from spores on a wide variety of media and a broad spectrum of environmental conditions have been, to date, uniformly unsuccessful.

PROGRESSION AND PATHOGENICITY OF THE DISEASE

Normal, uninfested specimens of *C. bairdi* possess an orange, somewhat iridescent exoskeleton. The external manifestation of the syndrome begins as small discrete black spots, usually on the dorsal cephalothorax, which enlarge and coalesce to cover much of the dorsal aspect of the cephalothorax (Fig. 1). Eventually the entire cephalothorax is completely covered with a black tarry mass of hyphae and fruiting bodies, which eventually spread to the appendages and ventral surface of the crab (Fig. 2). Less frequently, the encrustations appear first on one or more of the walking legs or on the legs simultaneously with carapace involvement. Also, encrustation of the eye stalk usually occurs early in the syndrome.

Removal of the carapace and examination of internal tissues for evidence of fungal invasion is unrevealing, except that the epidermis is more than normally adherent to the inner surface of the exoskeleton. There are no grossly evident, pigmented hyphae and no recognizable disturbance of the normal architecture.

Microscopic examination reveals that the surface encrustations consist of a mass of thick-walled, pigmented hyphae and fruiting bodies or perithecia (Fig. 3). Within each mature perithecium numerous asci develop, each of which contains eight spores (Fig. 4). There is a long, thin filament tightly wound around each end of the spore, which, when the spore is discharged, unwinds (Fig. 5) and presumably aids in the attachment of the spore to a potential host.

Examination of unstained squash preparations of the epidermis of crabs with external encrustations clearly reveals that fungal hyphae are present. Sections of carapace and underlying epidermis and subepidermal tissues stained with Grocott's Methenamine Silver (GMS) demonstrate that the hyphae readily penetrate the thick chitinous carapace. Even in light-to-moderate infections, as measured by the extent of encrustation, random samples of the subepidermal tissues are packed with proliferating bundles of sparingly branched, sparingly septate hyphae (Fig. 6). As they proliferate, the hyphae invade, destroy, and almost completely replace all tissue components in the subepidermal layer.

As the intensity of the infection increases, tissues and organs beneath the subepidermal layer are invaded, with the primary route of invasion via the connective tissue that supports the major

¹Resource Assessment and Conservation Engineering Division Northwest and Alaska Fisheries Center, National Marine Fisheries Service, NOAA, 2725 Montlake Boulevard East, Seattle, WA 98112.

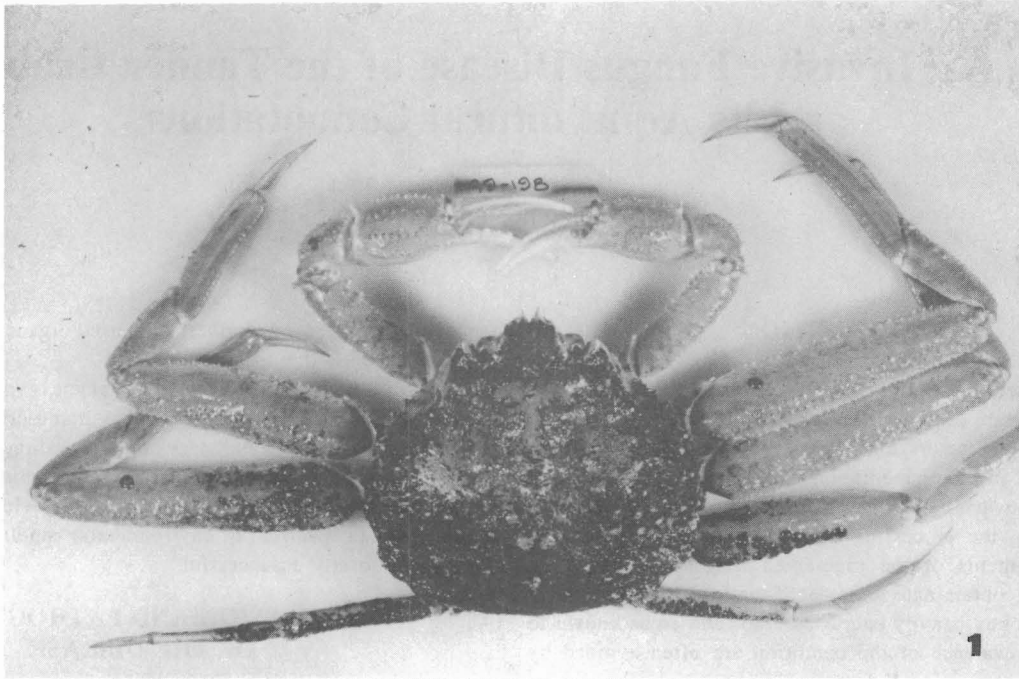

Figure 1.—A Tanner crab with black mat syndrome. Most of the dorsal cephalothorax is covered and the encrustation is spreading to the legs. Most of the round structures on the 3rd right walking leg are epibionts, not fruiting bodies.
Figure 2.—A heavily encrusted crab, almost completely covered by fungal hyphae and fruiting bodies.

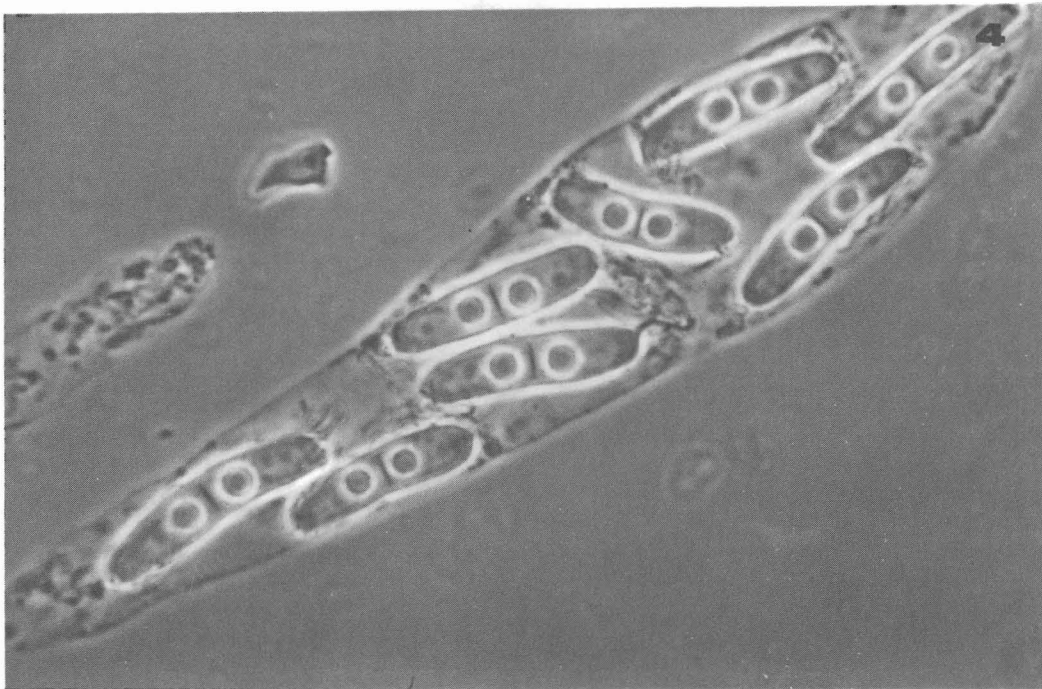
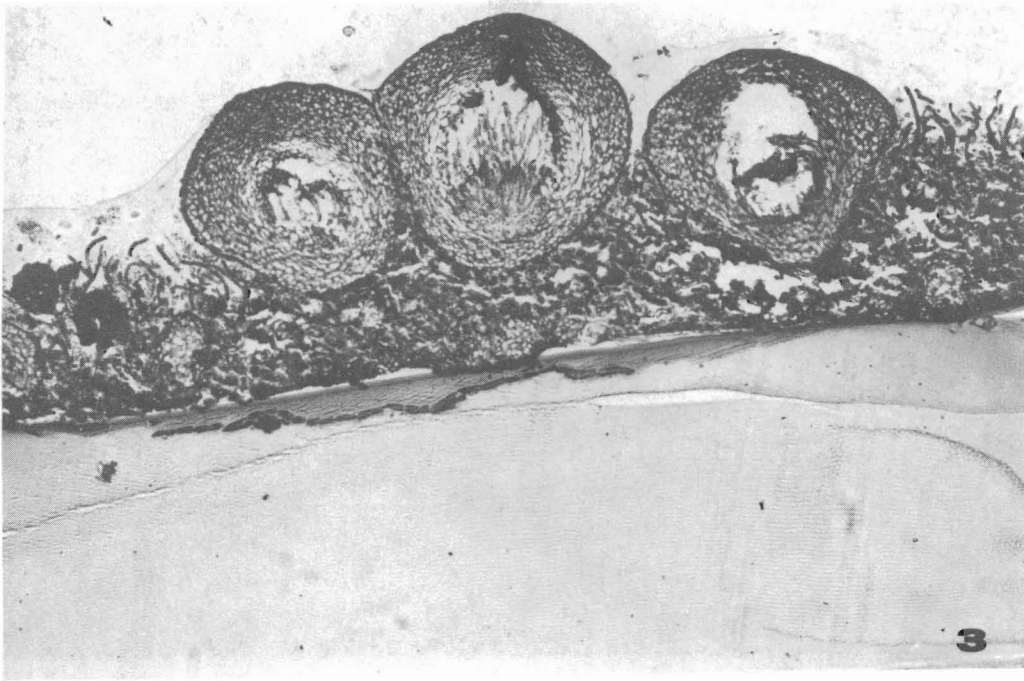

Figure 3.—Section of carapace and external mat of hyphae and fruiting bodies (Perithecia). GMS X100.

Figure 4.—An ascus containing 8 spores of the fungus. Phase contrast, fresh mount of unstained ascus. X1550.

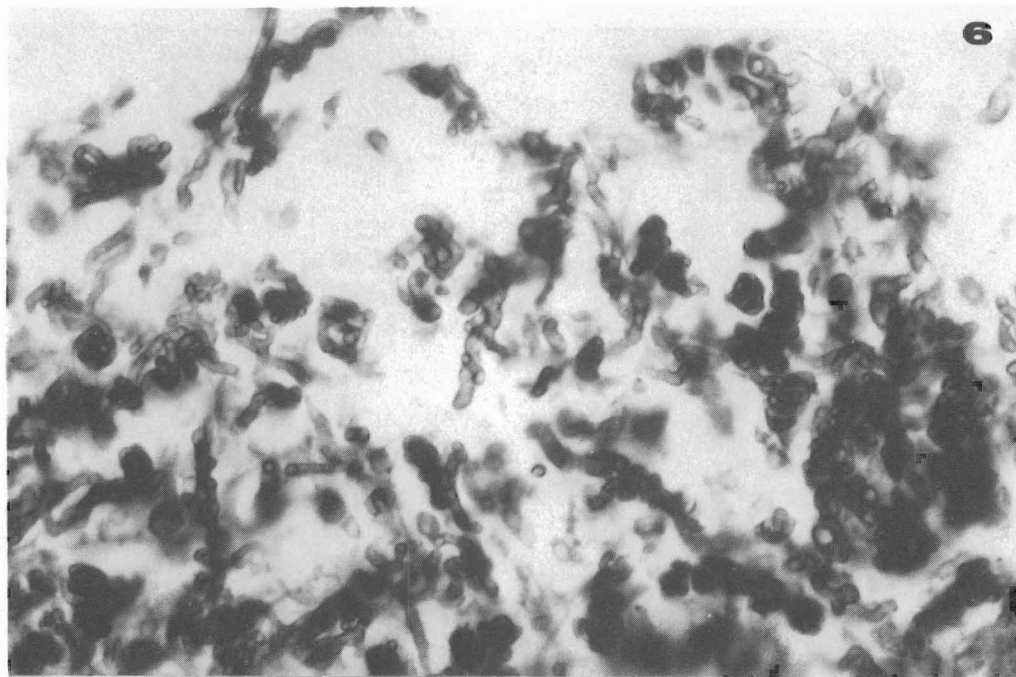
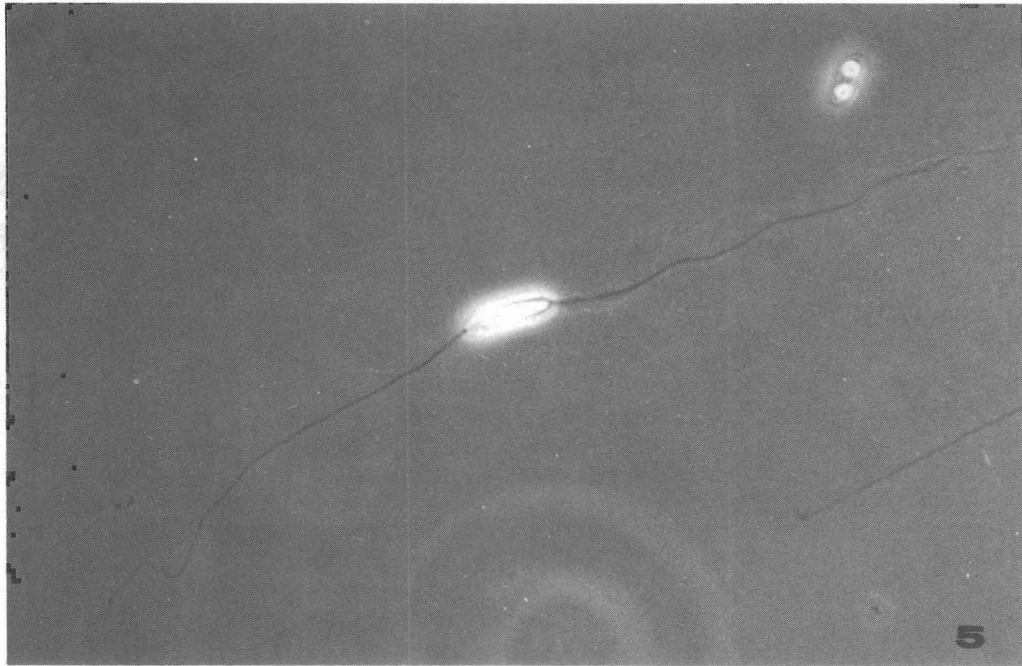

Figure 5.—A free spore with polar filaments with filaments extended. Phase contrast, unstained. X620.

Figure 6.—Subepidermal tissue containing numerous sparingly branched, sparingly septate hyphae. GMS X620.

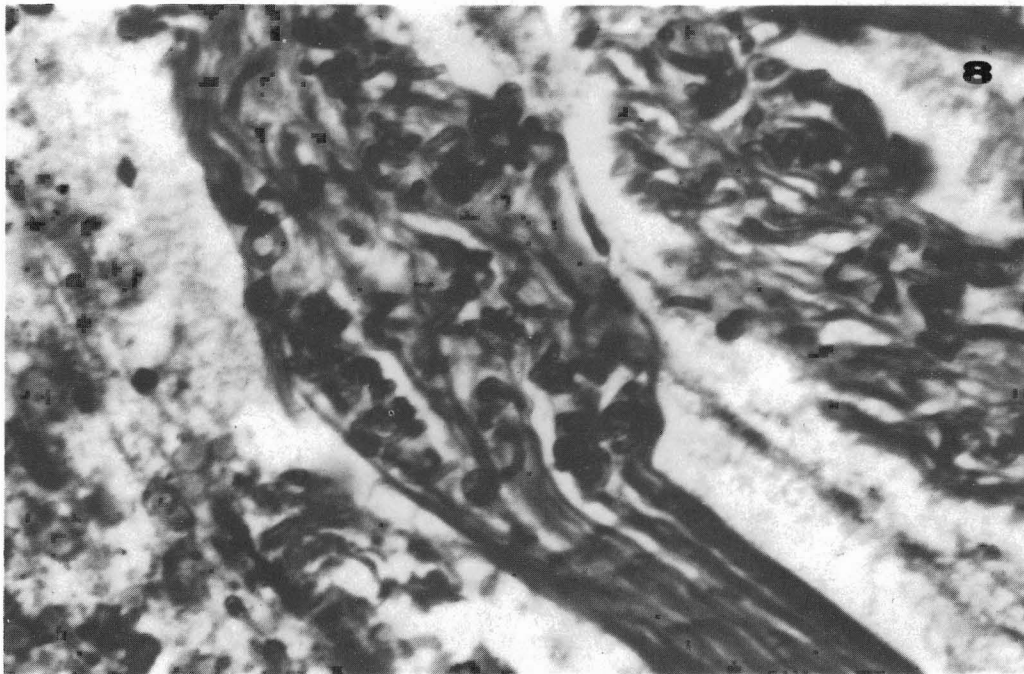
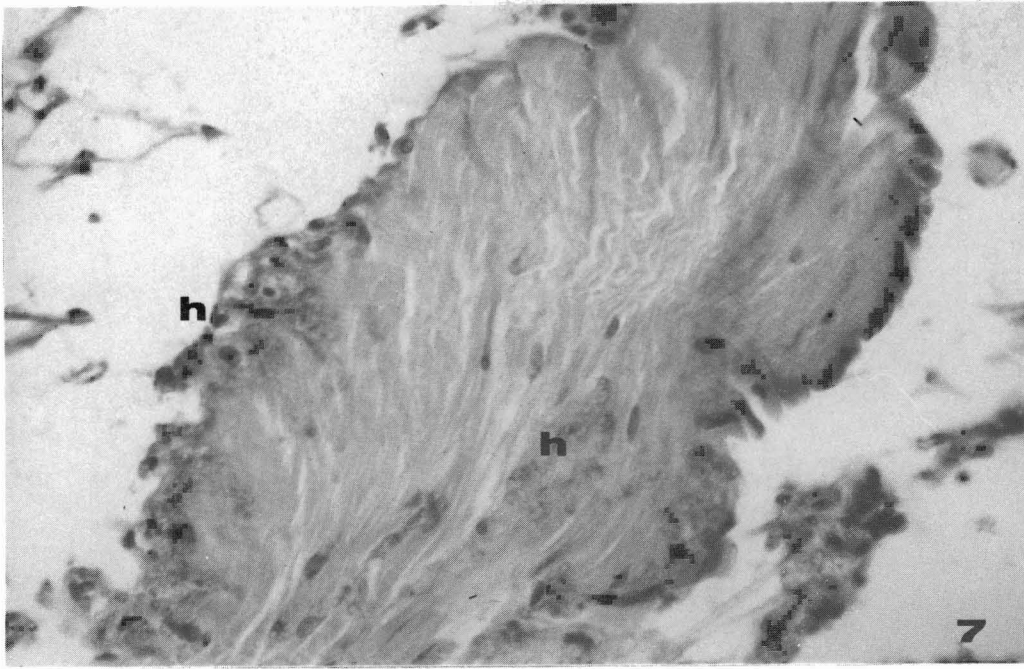

Figure 7.—A deep muscle of the cephalothorax invaded at the periphery and in the interior by hyphae (h). Hematoxylin & Eosin X250.

Figure 8.—Eye muscles invaded by hyphae. Note the swelling in the infected portion of the muscle in the center of the photomicrograph and the loss of architectural integrity of the muscle at the upper right. GMS X620.

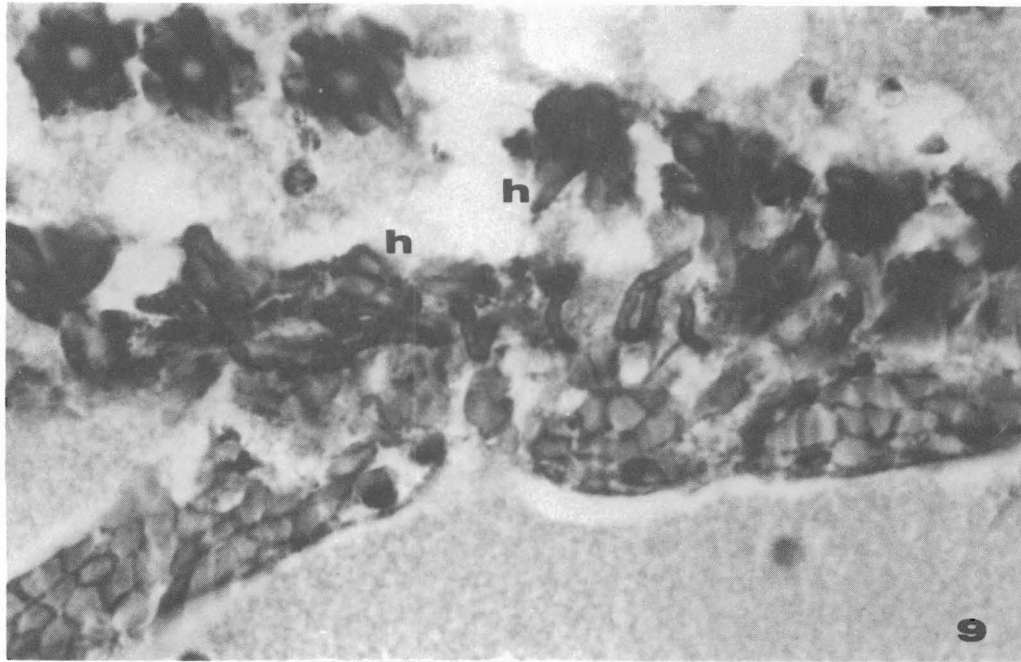

Figure 9.—Destruction of reticular cells of the rhabdomes in the retina by invading hyphae (h). GMS X620.
Figure 10.—Complete destruction of retina by invading hyphae. Note the numerous bundles of hyphae, infiltrating hemocytes and extensive melanization. GMS X250.

organs. However, deep muscles are frequently involved, with the hyphae first invading the periphery of a muscle then growing inward along the edges of muscle bundles (Fig. 7). Frequently, the connective tissue and muscles adjacent to the hematopoietic organ contain numerous hyphae and occasionally the interlobular connective tissue and the hemopoietic tissue proper is invaded and destroyed.

The walls of deep blood vessels, as well as those in the subepidermal layer, are invaded and occasionally even in nonmoribund crabs, the fibrous connective tissue comprising the wall of the heart contains masses of hyphae. Sometimes the wall of the esophagus, cardiac stomach, and hindgut are invaded.

Hyphae and perithecia are frequently present on the external surface of the eyestalk and virtually all infected crabs have eyestalk invasion. The epidermis and subepidermal layer, as in the cephalothorax, are first invaded, then hyphae extend into the muscles of the eyestalk, disrupting the normal architecture and destroying the muscles (Fig. 8). Somewhat later, hyphae grow along the retinal basement membrane and subsequently invade the retina, where they proliferate between the rhabdomes and invade and destroy the reticular cells of the rhabdomes (Fig. 9). Eventually, many crystalline cones of the retina are invaded and disrupted. Although host defense mechanisms are usually minimal, marked hemocytic infiltration sometimes occurs and melanization of the destroyed retina follows (Fig. 10).

Fruiting bodies and external hyphae may occur on the external surface of gill lamellae with the underlying lamellar tissue invaded and replaced by a solid mass of proliferating hyphae. The base of the gill may also be involved, with invasion of connective tissue and podocytes.

DISCUSSION

It is probable, from the massive destruction of the epidermis and subepidermal tissues, that crabs infected with the fungus are unable to molt. However, I have not been able to verify this experimentally because of lack of a laboratory seawater system with facilities to sterilize the effluent water and destroy infective spores. There is circumstantial evidence that infection prevents molting, in that areas of known high incidences of the black mat syndrome are also areas of high percentages of skip-molt crabs. Further support is provided by the fact that I have never found internal hyphae in a crab lacking external encrustation. If I am correct in my assumption that infected crabs are unable to molt, infected sublegal crabs will never enter the fishery.

Because of the obvious ease with which the hyphae invade tissues and the massive proliferation and destruction accompanying the invasion, it also seems likely that the disease is lethal to in-

fecting crabs. Further evidence for this assumption is the apparent inability of infected crabs to mount a successful defense mechanism. To date, almost all the infected crabs examined have been collected by crab pot, an unlikely source for moribund animals. Also, crabs near death are more susceptible to predation and are probably quickly removed from the population. However, the lethality and the time required for the disease to kill crabs requires laboratory confirmation. If the disease is proven to terminate fatally, it may, at least partially, explain recent population declines (up to 50%) in *C. bairdi* stocks in Alaska.

Sparks and Hibbits (1979) believed that the mycosis begins on the surface and then penetrates the chitinous exoskeleton to invade internal tissues, rather than, as many fungal parasites of arthropods do, becoming established internally before developing reproductive structures externally. This assumption is based on the fact that internal invasion has been present in every crab with external fungi examined but none of the many crabs lacking the external encrustations contained internal hyphae. There is no question, however, that the internal hyphae provide the nutrient for the external hyphae and fruiting body growth.

The mycosis presents a potential problem in the event that the Tanner crab becomes a cultivated species. Of more immediate importance, however, the information needed on the mechanism of infection, progression of the disease, effect on molting, and lethality, can be effectively obtained only under controlled aquaculture conditions. Thus, aquaculture can provide data of value for the management of wild populations.

ACKNOWLEDGMENTS

The highly skilled technical assistance provided by Jolly Hibbits is gratefully acknowledged. She necropsied and processed all the crabs, studied the spore morphology and did the taxonomic work required to determine that the fungus was an undescribed genus and species of Ascomycetes. The cooperation of Al Kimker, Alaska Department of Fish and Game, in collecting and shipping live crabs from Alaska is also greatly appreciated.

LITERATURE CITED

- MIX, M. C., and A. K. SPARKS.
1980. Tanner crab *Chionoecetes bairdi* Rathbun haemocyte classification and an evaluation of using differential counts to measure infection with a fungal disease. *J. Fish Dis.* 3:285-293.
- SPARKS, A. K., and J. HIBBITS.
1979. Black mat syndrome, an invasive mycotic disease of the Tanner Crab, *Chionoecetes bairdi*. *J. Invertebr. Pathol.* 34:184-191.
- Van HYNING, J. M., and A. M. SCARBOROUGH.
1973. Identification of fungal encrustation on the shell of the snow crab (*Chionoecetes bairdi*). *J. Fish. Res. Board Can.* 30:1738-1739.



Statement of Tenth Joint Meeting of the UJNR Aquaculture Panel, Molluscan Culture, Lewes, Delaware, October 27, 1981

The Tenth Joint Meeting of the UJNR Aquaculture Panel was held on October 27, 1981, at the Marine Science Center, University of Delaware, Lewes, Delaware.

Dr. Takeshi Nose, Secretary General of the UJNR Aquaculture Panel, acted as chairman for the Japanese Panel because Dr. Hanamura could not attend. Mr. Conrad Mahnken was chairman for the United State Panel. Dr. Nose announced a change of officers for the Japanese delegation. Dr. Akira Suda, former chairman, has accepted a new position as Executive Director of Japan Sea Farming Fisheries Association. In his place, Dr. Nobuhiko Hanamura has been appointed as the new chairman, Japanese Panel. Rapporteurs for the tenth meeting were Dr. Kouichi Ohwada and Mr. Ben Drucker.

Mr. Robert Wildman was appointed as the new Vice-Chairman of the U.S. Panel to replace Dr. Tapan Banerjee, who has accepted a position with the U.S. Agency for International Development in Indonesia.

1. Scientist Exchange

The scientist exchange program sponsored by UJNR is an effective means of exchanging information on aquaculture between the two countries and was continued between the Ninth and Tenth UJNR meetings. During this period:

- Dr. Arai and Dr. Wada visited the NMFS, Seattle, Washington, Laboratory and the University of South Carolina, respectively.
- Graduate students from the University of California and Western Washington University visited the Tohoku Regional Fisheries Laboratory and the Oyster Research Institute.
- Three members of the Japanese Panel of the UJNR and three scientists as observers, attended the Tenth Joint UJNR Meeting and the Second International Conference on Aquaculture Nutrition.
- In 1982, Dr. Nagahisa Uki will visit the United States to do research on abalone aquaculture.

2. Literature Exchange

For the period 1980-1981, the Japanese Panel sent to the U.S. Panel 120 scientific papers. During the same period, the U.S. Panel sent to Japan 78 scientific papers. At the Tenth UJNR Meeting, the Japanese delegation presented to the U.S. Panel five copies of a publication entitled "Review on Aquaculture Research in Japan."

A computerized data base for literature surveys in the field of aquaculture is currently available to Japanese UJNR members.

3. Cooperative Studies

An up-date of ongoing programs was presented. These included:

1) Registry of Marine Pathology

This program has been most successful and will be continued in the future. It is hoped that a publication will result in a photographic atlas of diseases of marine and freshwater fishes.

2) Mass Mortality of Oysters

This program has been ongoing for a number of years and the principal investigators will decide whether or not to continue the study.

3) Disease Resistance of U.S. Oysters in Japan

Strains of disease resistant oysters have been sent to Dr. Kan-no by Dr. Chew, and comparisons have been made with wild populations. This program should be completed.

4) Cooperative Studies on Abalone

Dr. Uki will be visiting the United States in 1982, and he will discuss with U.S. investigators the potential for a cooperative program beneficial to both countries.

At this time, the U.S. Panel has no new cooperative projects to propose. However, during the coming year they will look into the potential for establishing cooperative programs such as:

- Smoltification
- Reproductive physiology
- Comparative nutrition

-Water re-use systems

-Pond dynamics

The Japanese Panel also has no new proposals to suggest at this time.

Any proposals developed during the coming year will be sent to the Chairmen of the Japanese and U.S. Panels prior to the next meeting in adequate time for review.

4. Second Five-Year Plan

The following schedule was agreed upon as the second five-year plan for UJNR activities:

YEAR 1 (Japan) - Salmon Enhancement (ocean ranching, salmon farming, public hatchery systems, carrying capacity, smoltification, seeding, nutrition, evaluation of stream stocking, etc.)

YEAR 2 (USA) - Aquaculture Engineering (emphasis on structures and new automated technology in aquaculture systems)

YEAR 3 (Japan) - Environmental Quality in Aquaculture Systems (water quality, self-pollution, water re-use systems, and animal health)

YEAR 4 (USA) - Reproductive Physiology (genetics and breeding of aquaculture species)

YEAR 5 (Japan) - Marine Ranching

5. Publications

An editorial policy was agreed on by both Panel Chairmen. This accepted policy includes:

-Papers are to be written in English

-All papers will be published by the U.S. side with one Japanese and one U.S. scientist as co-editors

-For maximum coverage, the papers will be published as an official publication

-Papers will be summarized at meetings

-Papers will be distributed to members and observers prior to presentation at the annual meeting

-Publications consist of three types of papers:

-Overview papers

-Status of research papers, and

-Technical papers

The 1978 and 1979 papers are currently being prepared for publication by Dr. Sindermann. The 1980 and 1981 papers will appear as a single publication.

6. Next Joint Meeting

The next meeting of the UJNR Panel is scheduled for Tokyo, Japan, in mid-October 1982. The meeting theme will be "Salmon Enhancement." A field trip to northern Japan will follow the business meeting.

Conrad Mahnken - United States

Takeshi Nose - Japan

An Attempt to Culture the Noble Scallop, *Mimachlamys nobilis* Reeve, Using a Microparticulate Diet

AKIO KANAZAWA, SHIN-ICHI TESHIMA, MINESHI SAKAMOTO,
HIKARU MATSUBARA,¹ and TAKEMITSU ABE²

ABSTRACT

This paper deals with the attempt to culture the noble scallop, *Mimachlamys nobilis* Reeve, using two types of microparticulate diets. Carrageenan-microbound diet (MBD) or nylon-protein microencapsulated diet (MED) was fed together with marine *Chlorella*. As a control, marine *Chlorella-Chaetoceros* were fed following the methods of the Fisheries Experimental Station of Oita Prefecture. Higher growth and survival rates of the scallop larvae were attained in the group fed marine *Chlorella*-carrageenan MBD (1:1). The shell length of scallops fed this diet reached 995 μm average, with 19.2% survival over 47 d. The shell length of the control scallops fed marine *Chlorella-Chaetoceros* was 875 μm average, with 4.8% survival over 49 d. Scallops fed marine *Chlorella*-nylon protein MED (1:1) showed similar growth and survival to scallops fed only marine *Chlorella* and died in about 23 d without reaching the sessile stage. The results of the present study indicate the possibilities of rearing larval scallops and other pelecypods on microparticulate diets composed of ingredients which satisfy the nutritional requirements of these animals.

INTRODUCTION

During the past 4 yr, we have tried to make a microparticulate diet for larval fish and crustaceans as substitutes for live food, such as *Chaetoceros* and the rotifer *Brachionus plicatilis*. We have succeeded in rearing the larval prawn *Penaeus japonicus* from zoea to postlarvae on an artificial diet alone, and have demonstrated that the growth and survival rate of prawn fed artificial diets were almost comparable with those of prawn fed live food.

The noble scallop, *Mimachlamys nobilis* Reeve, is one of several promising species for aquaculture in Japan. Seedling production of this scallop has been carried out using marine *Chlorella*, *Chaetoceros*, *Monochrysis*, *Phaeodactylum*, and rotifers as dietary organisms (Yamada 1980; Nanba 1980). However, it requires excessive manpower and expensive facilities to culture these planktonic organisms. In the present study, an attempt was made to culture the larvae of the noble scallop using microparticulate diets.

MATERIALS AND METHODS

Noble Scallop Larvae and Culture Methods

Spawning was induced by stimulating mature females by both exposure to air and temperature control as described by Shiihara and Takeda (1978). After hatching, the D-type larvae (population density, 1 larva/ml) were reared until the sessile stage in an aerated 100 l round tank with its sides covered with a black plastic sheet. Thirty percent of the water was renewed every 3 d by filtration through a fine net (mesh size, 25 μm). Larvae at the sessile stage were reared by hanging the oyster shells as a culch in running water with a flow rate of 100 l/d.

Feeding Experiments

Four experimental groups were chosen: Group 1 received a marine *Chlorella* sp.-carrageenan microbound diet (MBD), 1:1. Group 2 received a marine *Chlorella* sp.-nylon protein microencapsulated diet (MED), 1:1. Group 3 (control) was reared on marine *Chlorella-Chaetoceros calcitrans* by the method employed at the Fisheries Experimental Station of Oita Prefecture (Shiihara and Takeda 1978). Group 4 was maintained on marine *Chlorella* alone. The nylon-protein MED was prepared as described previously (Jones et al. 1976). The method for preparation of the carrageenan-MBD will be reported elsewhere. The diets were supplied to larvae on the basis of the following formula during the period of hatching to 400 μm length:

$$\text{Diet supplied (particles/ml)} = 150 \times \text{shell length } (\mu\text{m}) \\ - 7,500 \text{ cells or granules/ml} \\ \text{water.}$$

The diet supplied was expressed as the number of diet particles/ml of medium. For the larvae (shell length $\geq 400 \mu\text{m}$), 65,000 cells or granules/ml were supplied. Tables 1 and 2 show the composition of carrageenan MBD and nylon-protein MED. The composition of nylon-protein MED was the same as that of the purified diet for *P. japonicus* (Kanazawa et al. 1977) except for trace amounts of Na_2SiO_3 .

RESULTS AND DISCUSSION

The results of the feeding experiments are shown in Table 3 and Figure 1. Noble scallop larvae fed *Chlorella*-carrageenan MBD showed superior growth and survival to those fed control diets (*Chaetoceros-Chlorella*). A marked difference was seen in the survival rates between the *Chlorella*-carrageenan (19.2%) and control (4.8%) groups, although the scallop larvae in both dietary groups attained the size utilized for raft culture at almost the same time.

¹Faculty of Fisheries, University of Kagoshima, 4-50-20 Shimoarata, Kagoshima 890, Japan.

²Oita Prefecture Fish Farming Center, Oita, Kyushu, Japan.

Table 1.—Composition of the carrageenan micro-bound diet (MBD). Diet particulate size: 5-8 μm diameter.

Ingredient	g/100g dry diet
Skim milk ¹	37
Chicken egg yolk ²	10
Chicken egg albumin	10
Tapes extract powder ²	10
Yeast extract powder ²	10
Pollack liver oil	6
Oleic acid (18:1 ω 9)	6
Amino acid mixture ³	5
Mineral mixture ³	1
Vitamin mixture ³	5

¹Morinaga Milk Company Co., Ltd.

²Riken Vitamin Co.

³Kanazawa, Teshima, and Tokiwa (1977) and Kanazawa, Teshima, Inamori, Iwashita, and Nagao (1981).

Table 2.—Composition of the nylon-protein microencapsulated diet (MED). Diet particulate size: 5-8 μm .

Ingredient	g/100g dry diet
Casein	50.0
Starch soluble	4.0
Glucose	5.5
Glucosamine HCl	0.8
Na-citrate	0.3
Na-succinate	0.3
Cholesterol	0.5
Pollack liver oil	6.0
Soybean lecithin ¹	6.0
Mineral mixture	8.54
Vitamin mixture	6.0
l-Methionine	0.5
l-Tryptophan	0.5
Cellulose	1.65

¹Nakarai Chemicals, Ltd.

Table 3.—Results of the feeding experiment.

Dietary group	Feeding period (d)	Growth shell length (μm)	Survival (%)	Survival (%) of raft cultured specimens ¹
1 <i>Chlorella</i> + Carrageenan MBD	47	995	19.2	4.7 (4,725) ²
2 <i>Chlorella</i> + Nylon protein MED	22	—	0.0	—
3 <i>Chlorella</i> + <i>Chaetoceros</i>	49	874	4.8	0.8 (759) ²
4 <i>Chlorella</i>	24	—	0.0	—

¹One month after being transplanted to sea.

²Number of live specimens.

The difference in survival rates between both experimental groups seemed to be attributable to mortality at the beginning of umbo-period and at the pigment-cell stage.

Larvae maintained on the nylon-protein MED showed similar growth and survival rates to those fed *Chlorella* alone, but their growth and survival rates were lower than those maintained on the *Chlorella*-carrageenan MBD and control diets. Larvae of the latter

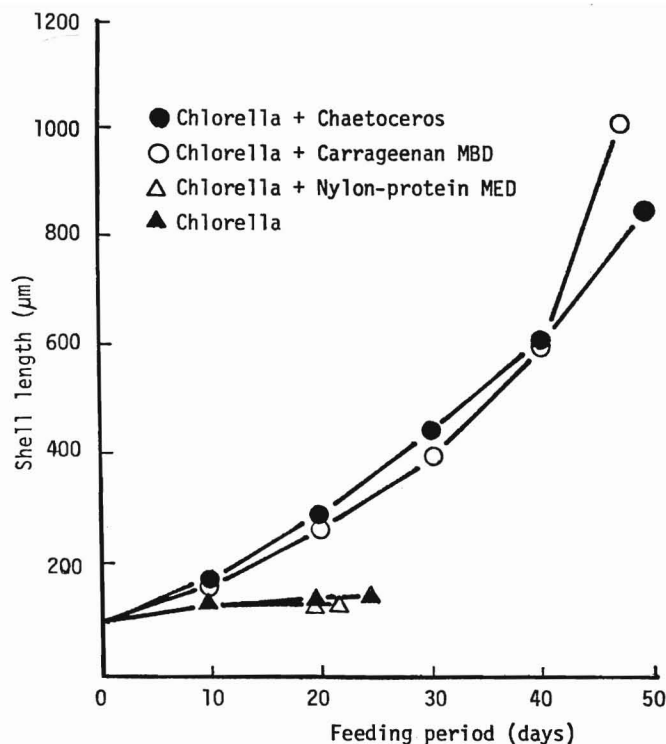

Figure 1.—Growth of larvae of the noble scallop during the feeding period.

two dietary groups reached the sessile stage in about 12 d, whereas those of the former two dietary groups did not attain the sessile stage even after 23 d, when mortality was complete. In addition, larvae of the noble scallop reared on *Chlorella*-carrageenan MBD showed a higher survival rate than those fed live food and *Chlorella*-*Chaetoceros* 1 mo after being transplanted to the sea.

The present study shows the possibility of using the carrageenan MBD as a substitute for *Chaetoceros* for rearing larval stages of the noble scallop. Also, this study indicates the possibility of rearing the larval scallop and other pelecypods with micro-particulate diets as long as they are composed of ingredients which satisfy the nutritional requirements of these animals.

LITERATURE CITED

- JONES, D. A., T. H. MÖLLER, R. J. CABELL, J. C. MUNFORD, and P. A. GABBOT.
1976. Crustacea. In G. Persoone and E. Jaspers (editors), Proc. 10th European Symp. Mar. Biol., Oostend, Belgium, 1975, p. 229-239. Universa Press, Wetteren, Belgium.
- KANAZAWA, A., S. TESHIMA, S. INAMORI, T. IWASHITA, and A. NAGAO.
1981. Effects of phospholipids on growth, survival rate, and incidence of malformation in the larval ayu. Mem. Fac. Fish., Kagoshima Univ. 30: 301-309.
- KANAZAWA, A., S. TESHIMA, and S. TOKIWA.
1977. Nutritional requirements of prawn—VII. Effect of dietary lipids on growth. Bull. Jpn. Soc. Sci. Fish. 43:849-856.
- NANBA, T.
1980. Seed production of *Chlamys (Mimachlamys) nobilis*. Rep. Fish. Exp. Stn. Wakayama Pref. 6:112-119.
- SHIHHARA, H., and T. TAKEDA.
1978. Studies on the artificial seed production of *Chlamys (Mimachlamys) nobilis* - I. Rep. Fish. Exp. Stn. Oita Pref. 10:59-65.
- YAMADA, O.
1980. Seed production of *Chlamys (Mimachlamys) nobilis*. Rep. Oita Fish. Corp., p. 19-25.

Recent Developments in Shellfish Culture in Southern Japan

GENERAL REMARKS

KAZUHIKO NOGAMI¹

There are a number of species of molluscan shellfish which have long been exploited by fisheries in southern Japan. At present about 30 bivalves and 10 snails are of particular importance for commercial exploitation. Cultivation and farming are also commercially important. Seven bivalves, including black lip pearl shell, giant wing oyster, noble scallop, oyster, pecten, ark shell, and pearl oyster, are actively cultivated. Furthermore, releases and transplantations on commercial and semicommercial scales in coastal areas are conducted for ark shells, clams, hard clams, noble scallops, round clams, and short-necked clams among bivalves, and abalone and snails among gastropods. Figure 1 schematically shows the major localities of these species.

Coastal waters in southern Japan provide suitable environments for the culture and farming of these species. Figure 2 shows the paths of the Kuroshio and Tsushima Currents that flow along the Pacific and Japan Sea sides of the area. It also gives distribution of isothermal profiles in the summer and winter. It is obvious that the dominating warm currents result in a moderate sea climate along the coast facing the open sea, ranging between 15° and 17°C in winter, and averaging about 27°C in summer. The seasonal change of climate is more extensive in the bays and in the inland sea.

Rocky shores prevail along the open coast, providing profitable zones for releasing and harvesting abalone. In 1979, 2.18 million abalone seeds were produced and released in the rocky zones. Efforts have been made to transplant young shells of hard clams on sandy bottoms: A Veneridae (*Meretrix lamarckii*) along Hiuchi Nada of the Seto Inland Sea, and another Veneridae (*Gomphina (Macriduscus) melanaegis*) along the Sea of Japan. Recently seeds of the ivory shell, *Barytonia japonica*, have been produced by a laboratory and then released in coastal waters with sandy or muddy bottoms along Tottori Prefecture. The scallop, *Pecten albicans*, is actively cultured in the eastern part of Shimane Prefecture. These two prefectures are in the Chugoku Region and face the Sea of Japan (Fig. 2). Subtropical species are cultured in the South

West Islands: The giant wing oyster, *Pteria penguis*, in bays of the Amami Islands, the black lip pearl shell, *Pinctada margaritifera*, in lagoons of the Yaeyama Islands, and the noble scallop, *Chlamys nobilis*, in the Okinawa Islands and in other coastal areas facing the Pacific Ocean.

The Seto Inland Sea is the most representative enclosed area in Japan. Oceanic waters come in and flow out only through two channels at the southeastern and southwestern ends. A number of rivers and streams flow into the shallow sea with an average depth of 31 m. These factors cause wide variation of temperature and salinity in the sea. Tidal range averages 3.5 m in the central portion. The maximum velocity of tidal current is recorded to be as fast as 10 kn. These remarkable variations in the environment favor the propagation and farming of diverse bivalves and other mollusca. Besides the famous oyster culture, farming grounds of the short-necked clam, *Ruditapes philippinarum*, and the hard clam, *Meretrix lusoria*, have developed in the sandy littoral beaches around river estuaries. Pilot programs are also being conducted for other species in the tidal beach areas. Young of the bivalve of the ark shell, *Scapharca subcrenata*, collected from natural beds are transplanted into muddy coastal waters of 4-5 m depth. Hatchery-reared ark shells are cultivated in cages or released on the bottom in coastal areas of 10-30 m depth.

Hiroshima Bay and adjacent waters have long been utilized for the culture of edible and pearl oysters. Abalone have been released along the rocky shores receiving the influence of warm, swift currents. Pectens are reared by the hanging method during the cold season. Hard clams are often cultivated or released, on an experimental scale, in sandy bottom areas.

The Ariake Sea, western Kyushu, is characterized by wide expanses of tidal flats, an extensive tidal range of 6 m, and wide ranges in temperature and salinity. Significant natural production by young shellfish provides seeds for "intermediate breeding" (rearing from spat to any size).

¹Nansei Regional Fisheries Research Laboratory, Ohno-Cho, Hiroshima, Japan.

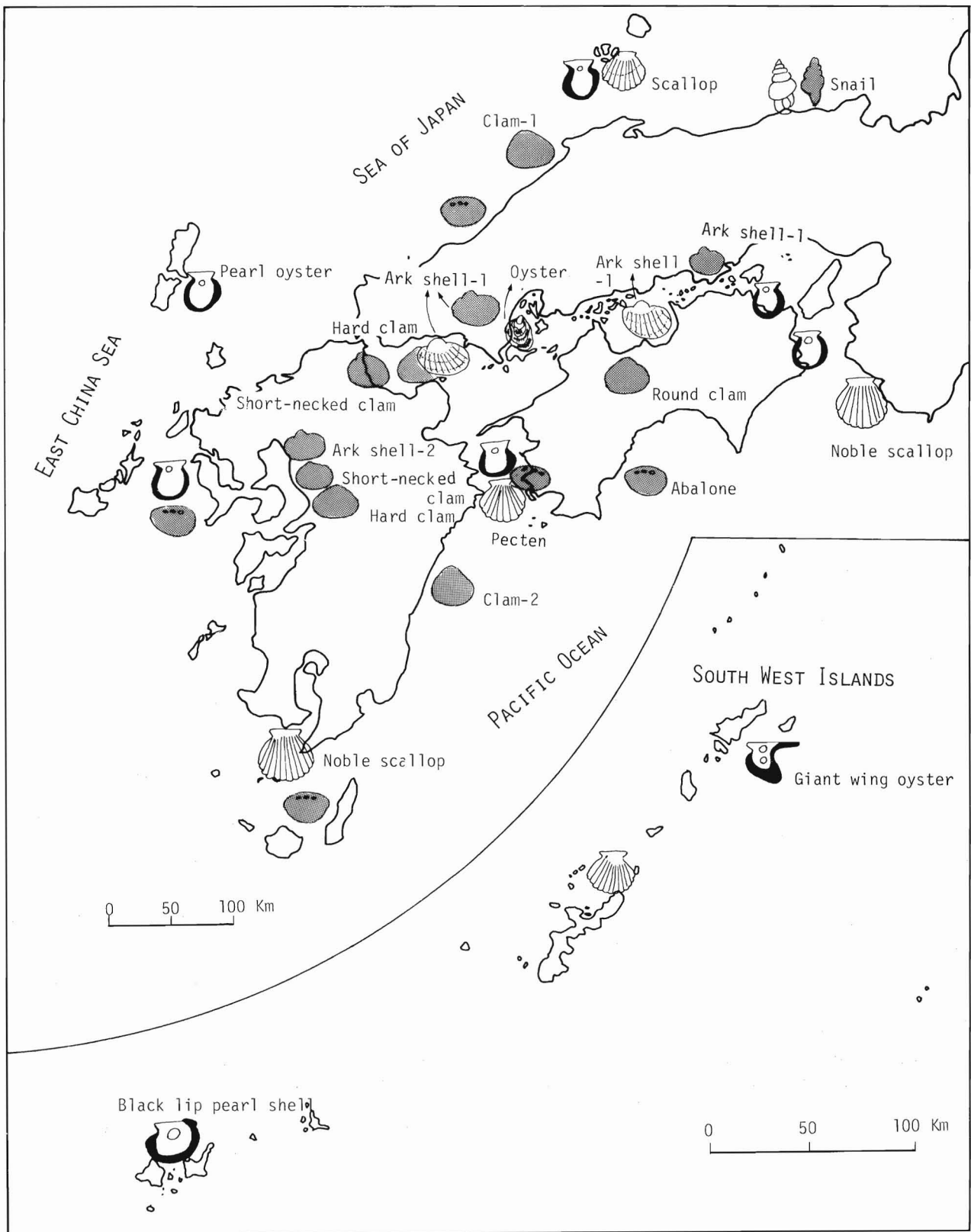

Figure 1.—Distribution of the major molluscan shellfishes for cultivation and farming in southern Japan. Shadow drawings represent species for release and transplantation. Blank drawings represent species for cultivation. Scientific names of the species in the map are: Abalone, *Haliotis discus* and *H. gigantea*; Ark shell-1, *Scapharca broughtonii*; Ark shell-2, *S. subcrenata*; Black lip pearl shell, *Pinctada margaritifera*; Clam-1, *Gomphia melanaegis*; Clam-2, *Meretrix lamarckii*; Giant wing oyster, *Pteria penguin*; Hard clam, *Meretrix lusoria*; Noble scallop, *Chlamys (Mimachlamys) nobilis*; Oyster, *Crassostrea gigas*; Pecten, *Pecten (Notovola) albicans*; Pearl oyster, *Pinctada fucata martensii*; Round clam, *Maetra maetra chinensis*; Snail, *Babylonia japonica*; Short-necked clam, *Ruditapes philippinarum*.

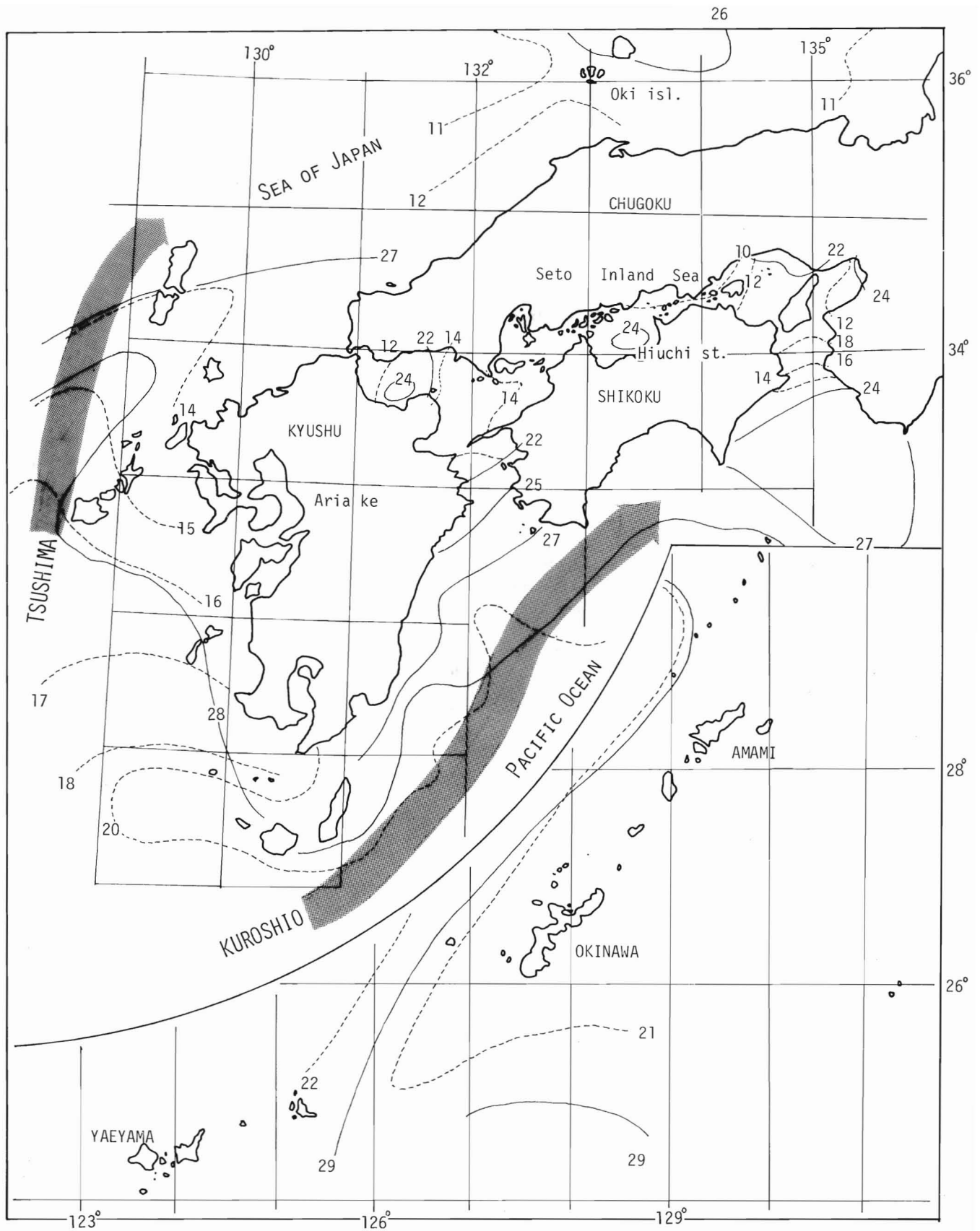

Figure 2.—Major ocean currents and surface isothermal contours in southern Japan. Arrows denote the Kuroshio and Tsushima Currents. Closed and broken lines denote average isothermal contours in August and in February, respectively.

OYSTER CULTURE IN HIROSHIMA PREFECTURE

OSAMU FUKUHARA¹

Hiroshima Bay and adjacent waters are well known for their long history of advanced oyster culture (Fujiya 1970; Furukama 1971). This industry has spread over Japan in the last 100 yr.

Oyster culture in Hiroshima has been a fairly stable industry both in amount of yield and in operation of the farms until the late 1960's. Since then, adverse problems have emerged, mostly due to deterioration of the environmental conditions of the oyster grounds and to a rise in operating costs. From a technical standpoint, the intention is to stabilize the harvest at an optimum level and to maintain the oyster grounds in suitable condition for this species, rather than to increase total production.

AMOUNT OF PRODUCTION

In Figure 1, the yield of oysters harvested from farms, the yield per raft, the number of rafts, and number of farms during 21 yr from 1959 to 1979 in Hiroshima Prefecture are given. During the approximately 20 yr, the annual production of oyster meat ranged from 10,000 to 30,000 t (metric tons), constituting about 50 to 70 % of Japan's total. Before 1969, the yield increased, together with an increase in the number of rafts and cultivation units. But a notable decrease in the yield occurred in 1969 and 1970. The decline in 1969 was attributed to mass mortalities of oysters due to adhesion of the shell of the annelid, *Hydroides elegans*. Furthermore, a strong typhoon hit the area during the summer, destroying many rafts and other facilities. This damage left its effect on oyster culture until 1970 and 1971, resulting in a decline in the number of rafts by nearly a quarter of that of the previous years. Since then, oyster production has been maintained at a moderate

level of about 20,000 t or slightly above. This can be attributed to the recovery of a number of rafts, even though the number of farms decreased continuously until the mid-1970's.

The incident in 1969 suggested that the recent crowding of rafts caused various ill effects upon the oysters, and eventually resulted in a decrease in productivity in the oyster ground. In this regard, it is noted that the yield per raft averaged around 2.5 t during the early years, but declined to around 2.0 t after 1972.

OYSTER FARMS

Oyster culture represents a typical coastal fishery in Japan. Usually members of a family work jointly. An oyster farm, or a unit of management of cultivation, is operated by a group of fishermen. About 50% of the units have 10 to 20 rafts each, but the largest farms use 100 rafts or more. The majority of farms employ 10 to 12 workers. Almost 80% of the employees are female part-time workers who shuck the shells during the harvest season, from November to April. The wage of these part-time workers constitutes about 50% of the total operating cost. Each of them shucks almost 40 to 50 kg of oyster meat per day, or about 4 t of oysters cultured on 1,000 to 1,200 strings during one season.

The number of oyster culture farms increased from 550 in 1959 to 920 in 1967, and then decreased until 1975, especially immediately after the serious damage to the industry in 1969. For the last 5 yr until 1979, the number of cultivation farms stabilized around 600 to 650 units (Fig. 1).

CULTIVATION PROCEDURES

Figure 2 schematically represents the current standard procedures used in oyster culture. The culture period lasts 2 yr.

¹Nansei Regional Fisheries Research Laboratory, Ohno-Cho, Hiroshima, Japan.

Figure 1.—Yield of oyster meat and number of facilities in Hiroshima Prefecture, 1959-79. Top: Closed and broken lines denote total yield and yield per raft, respectively. Bottom: Closed and broken lines denote number of rafts and number of farms, respectively.

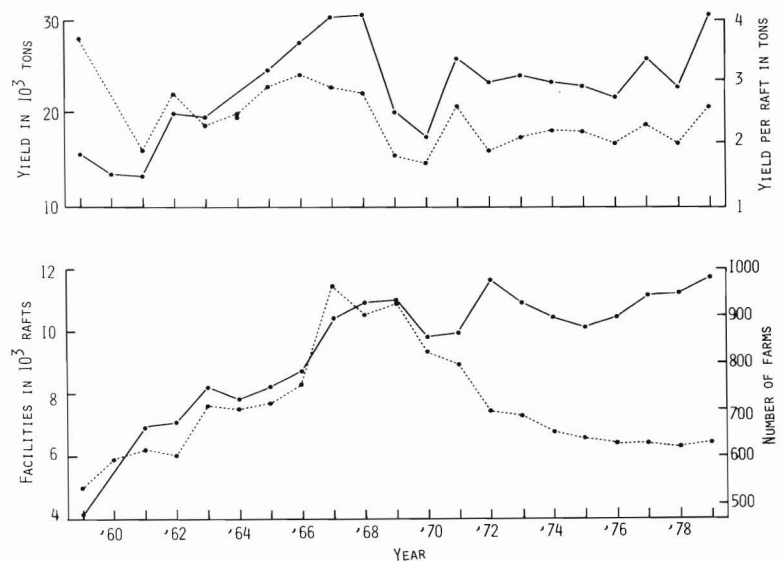

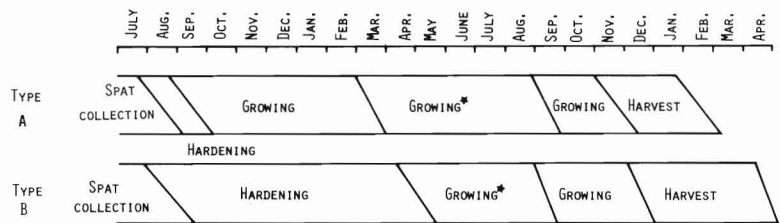

Figure 2.—Schematic representation of oyster culture. Asterisks denote a handling to keep the strings at deep layers of 2-5 m to prevent adhesion of fouling animals to the oysters.

Previously a short-period culture of 1 yr was used, but it was no longer used after 1964, possibly due to the rise in density of oysters that apparently resulted in the decline of food organisms and in the desolation of the sea bottom.

COLLECTION OF SPAT

Usually scallop shells are used to collect oyster spat. A collector is made of 70 scallop shells spaced from each other by a plastic tube, at intervals of about 2 cm, that is run through a semisteel wire of 1.6 m in length. The collectors are put on a rack installed in the littoral zones or hung from rafts in the oyster grounds. The fishermen collect a suitable number of spat, 40 to 50 animals per shell, by carefully regulating the duration of collection which ranges over several days. The chance to achieve such successful seeding occurs only one or twice every summer. In order to obtain reliable information for determining the optimum period for seed collection, the prefectural and municipal research organizations investigate the density of spat in the seawater, growth of the oyster spat, and density of such fouling animals as barnacles and mussels. This information is made available to the fishermen. In addition, the fishermen themselves and their cooperatives conduct similar surveys in the seeding areas, including counting spat on the monitoring collectors and swimming larvae in samples of plankton net collections.

HARDENING

Seed oysters collected on the rafts stay in the water for the whole day. These animals are less tolerant to exposure to air and other environmental changes, and must be hardened after growing below the raft for several days. This procedure is usually not required for spat collected on the racks in the littoral zone, which have already been exposed to air.

The seed oysters are transferred to hardening racks installed on the beach, and exposed for 6 to 10 h a day. This procedure retards growth of the spat but provides them the adaptability against environmental changes, and controls weak members among the spat.

Hardening commences in September and is then divided into two types of culture: "A" and "B". In type "A" culture, hardening ends in late autumn. Type "B" culture needs a longer hardening period of 7 mo, lasting through the following spring. Figure 2 schematically compares these types of oyster cultivations.

FATTENING

The seed oysters, hardened if necessary, are then transferred to fattening rafts. Scallop shells with seed oysters are hung on a semisteel wire of about 10 m in length, and set at an interval of 15 cm spaced by plastic tubes. The rafts are 165 to 190 m² on the surface, ranging between 8 and 9 m in width and 18 and 22 m in length.

Each raft carries 650 to 780 strings just below it. In the summer an additional string of 2 to 5 m is inserted between the raft and the rearing strings in order to prevent adhesion of barnacles, mussels, and other fouling animals that prevent growth of the oysters. Also harmful factors such as a decline of oxygen content, rise of temperature over an optimum level, or blooming of red tide are liable to occur in the warmer months. Fishermen shift the fattening rafts from coastal waters to the calm offshore waters around islands, until the autumn when the chance of encountering such harmful factors is reduced.

HARVEST FOR MARKET

Usually the harvest of marketable oysters starts in late October or early November. Almost all the oysters shucked by the end of January go to the markets for fresh consumption. From February to April, the percentage of oysters used in processing, including canning, freezing, and smoking, rises gradually at first and then more rapidly. Processing consumes about 30 to 50% of the total annual production in Hiroshima Prefecture.

PROBLEMS AND PERSPECTIVES

In Hiroshima Prefecture, approximately 10,000 rafts are used for oyster culture in an area of about 160 km². Thus the density is as high as 62.5 rafts/km² or 156 g of harvestable oyster meat or 780 g of living animals/m². Such overcrowding of the animals is the most probable cause of the decreased production of oysters per raft from 2.5 t in the 1960's to 1.0 t in the 1970's. Moreover, the high density of the oysters makes them vulnerable to environmental changes and contaminated farming grounds. This often results in tremendous fluctuation, causing a disastrous decline in production. Recently it was noted that the oyster grounds are beginning to display a symptom of "senescence." The Hiroshima Prefectural Fisheries Cooperative Associations and other organizations have initiated research to find a means to recover the oyster grounds.

In the past, a sufficient number of spat were collected by simple racks installed on the littoral zone in early summer. However, recent changes in both the topography of the coast and the techniques of oyster culture have required the introduction of seed collection with rafts. Reclamation of the littoral zone has progressed and has destroyed many spat areas therein. The transfer of oyster rafts to the island in summer reduces the number of spawners in the coastal area. Therefore, the role of rafts has become more important for the production of seed oysters than before. This requires a reliable and detailed forecast of the distribution and abundance of spat in order to assure efficient utilization of the rafts. In order to supplement the natural seeds, the Hiroshima Prefectural Fisheries Experimental Station is studying a practical production system of oyster spat based on artificial fertilization (Kusuki 1976).

Production of 20,000 to 30,000 t of oyster meat per year results in more than 120,000 t of oyster shells piled up from the oyster factories every year. Unpleasant odors and flies from the wasted shells create serious social problems. Unfortunately, only a small portion of the waste is used in forage and fertilizer. The bamboo poles of the oyster rafts last for 3 yr. In other words, the fishermen must replace 30% of the raft materials every year. At present, the bamboo is burned on the beach, creating other problems, such as pollution of seawater, obstruction of ships, and so on.

In addition, rising wages may affect management of oyster farms. It will be difficult to retain sufficient labor, especially for shucking the shells. Automation is rarely introduced to this part of the oyster cultivation procedure.

"Senescence" of the sea, in my opinion, is the most essential constraint in operating oyster farms in Hiroshima Prefecture. This

has been caused by overutilization of the sea for a long period. Therefore, some measures should be implemented to regulate the number of rafts at an optimum level and to conserve the fishing grounds.

LITERATURE CITED

- FUJIYA, M.
1970. Oyster farming in Japan. Helgol. wiss. Meeresunters. 20:464-479.
- FURUKAMA, A.
1971. Outline of the Japanese marine aquaculture. Jpn. Fish. Resour. Conserv. Assoc., June 1971, Tokyo, Japan, 39 p.
- KUSUKI, Y.
1976. Rearing larvae of Japanese oyster, *Crassostrea gigas* (Thunberg). Bull. Hiroshima Fish. Exp. Stn. 6/7:27-36.

CULTURE AND PROPAGATION OF BLOOD ARK SHELLS

KAZUHIKO NOGAMI¹

The blood ark shell, *Scapharca broughtonii*, is a relatively large-sized species among the edible mollusca, often reaching 15 cm in shell length. Its major habitat is in shallow bays and gulfs, 5 to 30 m in depth, with a flat muddy bottom. Their range extends from southern Hokkaido to Kyushu. These shellfish grow faster in the Seto Inland Sea and bays along Kyushu than in other localities. Furthermore, people in these areas highly value blood ark shells for their delicious taste in sushi and sashimi. Thus, this species is one of the most important for coastal fisheries. Intense demands for the blood ark shell have recently stimulated the initiation of artificial propagation and other cultivation techniques.

CULTURE BASED ON NATURAL SEEDS

It is possible to collect seeds of blood ark shells in early June with cedar leaves attached to a plastic net hung in coastal waters of 20 to 30 m depth. However, this technique is now employed only in a few prefectures of southern Japan, because the success of seed collection depends upon unstable natural factors including the abundance of spawners and environmental conditions.

ARTIFICIAL REARING

In 1961 it became possible to induce spawning of blood ark shells by temperature stimuli. The larvae were then fed with *Monas* sp. until spat stage (Kan-no 1963). According to Itami et al. (1970), the Hyogo Prefectural Fisheries Experimental Station produced 1 million spat in 1969. Later investigations made it possible to conduct mass production in the order of 1 million spat in many prefectures.

The Yamaguchi Farming Fisheries Center commenced mass production of seeds in 1976, and produced 10 million spat in that

and the next years. In the Center, the spawners are selected from the commercial catch taken by small coastal trawlers in late March and early April. Specimens used for seedlings exceed a minimum 90 mm in shell length and average 115 mm in length and 380 g in body weight. They are reared, without feeding, in plastic baskets hung in running filtered seawater. Under such conditions, 2 to 8% of the animals die by mid-June, but all the survivors mature when the water temperature rises to 20°C. For spawning induction, the animals are transferred to standing water heated to around 25°C and then to running water of around 28°C. The procedure lasts for about 7 h/d. Up to 80% of the spawners discharge eggs or sperm after repeating the temperature stimulation for 2 or 3 d.

Fertilized eggs are washed and then left for one day and night. Newly hatched larvae are reared in a 1-ton FRP (fiberglass-reinforced plastic) tank painted black at a density of 1.5 individuals/ml. The tank contains seawater leached with a 5 µm filter and aerated gently. The larvae are fed with a mixture of *Pavlova lutheri* and *Chlorella* sp. at a ratio of 1:8, spread in the water at a density of 10,000 individuals/ml.

Eighty collectors made of oyster shells are hung for each tank on the 20th day after fertilization. The seeds are harvested when they grow to 1 mm in shell length by early or mid-September. The survival rate is almost 88% from hatch out to the seed stage. The spat are then kept in lantern nets originally developed for pearl oysters for intermediate breeding until they reach 20 to 40 mm in length in the following March to July. During intermediate breeding, fishermen change the lantern nets several times, and replace one net with another of larger mesh. The survival rate during this period is about 30% (Ohashi and Koumoto 1980).

Thirty to fifty young of 20 to 40 mm just after intermediate breeding are kept in a 45 × 30 × 15 cm plastic cage, which is sunk to the bottom of the sea. The fattening continues until the following May when the shells grow over 70 mm in length and 100 g in weight.

¹Nansei Regional Fisheries Research Laboratory, Ohno-Cho, Hiroshima, Japan.

Most suitable cultivation grounds occur in the muddy bottom sea of 10 to 25 m depth. The survival rate reaches 80 to 90% in good culture grounds. Experimental rearing by the Nansei Regional Fisheries Research Laboratory indicated possible occurrence of mass mortalities of the shells in the cage at high bottom temperatures above 25°C and for wide diurnal changes in temperature exceeding 5°C. As a matter of fact, significant mortality was not reported in the cold summer of 1980.

RELEASE

There were several trials to release the 2 to 4 mm young after intermediate rearing. In Yamaguchi Prefecture at the western end of Honshu Island, 15,000 seeds of 40 mm in length and 15 g in weight were scattered in a location with a muddy bottom of 23 m in depth. One year later, trawlers harvested the ark shells which grew as large as 107 g in average weight. The recovery rate was one-third. No other trials succeeded to produce marketable shells.

It is likely that starfish are significant predators of the ark shell (Takami et al. 1979). Once Yamaguchi Naikai Fisheries Experimental Station released seeds of blood ark shells of 37.8 mm in mean length and 14.4 g in mean weight in several lots at diverse densities of 5 to 50 specimens/m². The starfish, *Asterias amurensis*, aggregated in the experimental area on the second day of the experiment, and their density reached 13 to 1,125 individuals/m² on the 18th day. The starfish dug out and fed on young ark shells. Eventually they preyed on all the shell seeds by the 39th day. Control of starfish led to a significant increase in the survival rate of

ark shells. In the next experiment, 500 shells were released in a 10 × 10 m area. Five plastic traps were set and seized 20 to 94% of the starfish. The results were encouraging—30% of the ark shells remained alive during 100 d. If the starfish are intensively controlled at the beginning, one can expect to obtain efficient results in the seed release program.

Recovery rates of natural seeds also showed remarkable variation depending on time and other conditions of release. The most successful results so far obtained were harvests of 25 to 30% of ark shells 1 yr after seed release.

PROBLEMS AND PERSPECTIVES

Figure 1 schematically shows the life history of blood ark shell stocks under cultivation and farming, and under exploitation. In both the cage culture and the releasing program, one can expect to harvest the shellfish 2 yr after birth. Because it takes 3 yr for blood ark shells to mature sexually, cultured individuals have no chance to contribute to reproduction.

Commercial trawlers exploit blood ark shells in five cold months between December and April. Fishing operations at the present intensities remove part of the 1-yr-olds, most of the 2-yr-olds, and almost all of the 3-yr-olds and larger. The spawning stocks comprise only a small fraction of 3-yr-olds which escaped exploitation. Therefore, the natural spawning stocks are very scarce and may not produce significant recruitment.

Figure 2 shows a plan to recover the ark shell stocks by protection of a portion of the fishing grounds as an artificial spawning

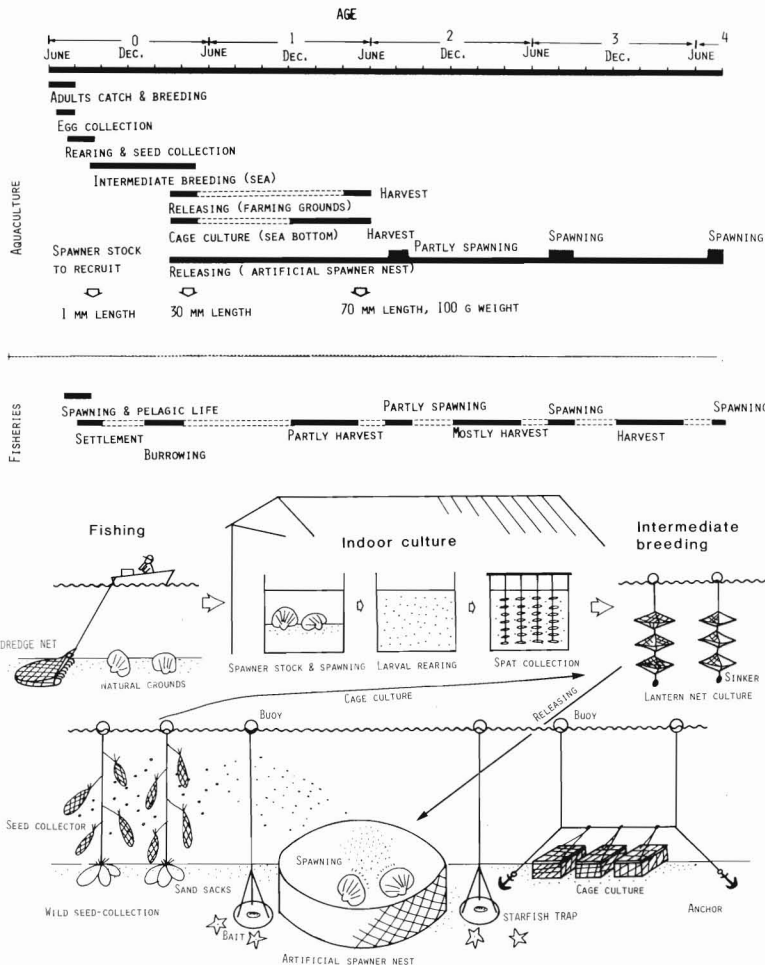

Figure 1.—Annual operations of blood ark shell production in aquaculture and fisheries.

Figure 2.—Schematic drawing of culture and aquaculture of the blood ark shell. Methodology of artificial spawner nest is studied under research project of marine ranching.

nest. Five problems must be solved in order to implement this plan.

1) A mass production system must be used to increase the seed supply beyond the present level of the order of 10 million 1 mm spats.

2) Optimum size of seeds for release must be determined, because there is no guarantee that the currently produced seeds of about 30 mm are of the optimum size.

3) Techniques for rearing the shells must be developed. The plastic cage method in current use requires tedious operations including frequent cleaning and exchange.

4) Research must be conducted to clarify the major factors affecting growth and mortality of the shells in the cultivation grounds. Emphasis must be put on clarification of lethal factors including high temperature and predation by starfish, and establishment of means to eliminate these factors.

5) Biological mechanisms for maturation and spawning must be clarified for manifestation of means to establish the spawning

stocks. Optimum size and density of spawners must be identified for efficient seed collection. Also comprehensive investigation must be conducted to relate biology of the blood ark shell with water, bottom, and benthic fauna.

LITERATURE CITED

- ITAMI, K., K. TANGE, K. YAMAUCHI, B. TAKEDA, and A. HAMAGUCHI.
1970. Studies on the production of an ark shell, *Anadara broughtonii* - I. Artificial breeding in tank. *The Aquaculture* 18(1):25-34.
- KAN-NO, H.
1963. Breeding of the ark, *Anadara broughtonii* (Schrenk), in tank. *Bull. Tohoku Reg. Fish. Res. Lab.* 23:108-114.
- OHASHI, H., and Y. KOUMOTO.
1980. Technical development for mass production of blood ark shell. *Rep. Tech. Dev. Farming Fish.* 6:80-135.
- TAKAMI, T., T. IWAMOTO, T. NAKAMURA, and H. INOUE.
1979. Studies on the aquaculture and production of the ark shell. *Spec. Publ. of Yamaguchi Pref. Naikai Fish. Exp. Stn.*

THE PRESENT AND FUTURE OF PECTEN CULTURE

SATOSHI UMEZAWA¹

Pecten, *Pecten (Notovola) albicans*, is one of the warm-water bivalves distributed in the coastal zones extending from southern Hokkaido to Kyushu. Their habitat is a sandy bottom of 10 to 80 m in depth. Coastal trawlers have exploited this shellfish for many years. Although production has remained at low levels in recent years, a sudden increase in the stocks has been reported in at least five prefectures of southern and central Japan between 1958 and 1968 (Kobayashi 1978; Tanaka 1977; Tanaka 1980). In other words, the pecten stock is an unstable fishery resource. But the species must be useful for utilizing sandy zones widely distributed in southern Japan. These areas have a very low productivity with only limited fishing activity, except for the culture of the seaweed *Undaria*.

Seed collection first succeeded in 1977 in Okinoshima (an island in the Sea of Japan), Shimane Prefecture. Since then, commercial cultivation of pecten has been practiced there. Production in the whole prefecture reached 300,000 pecten of marketable size in 1980, which were grown from 800,000 seeds collected in 1979 (Ayama and Matoba 1980). It is likely that this commercial cultivation will spread over other parts of the sandy coast along southern Japan.

Figure 1 illustrates the current practice of pecten culture in Shimane Prefecture, which is almost identical to techniques applied to related species of scallops in northern Japan. Table 1 lists various management operations, as well as size and survival of the

shells during the cultivation which lasts for 15 to 17 mo from February to July in the following year. At present, all the seeds are those collected in the sea, and no artificial propagation is practiced yet. The collectors are fine-meshed bags holding old fishing nets or cedar leaves, and are hung at middle to bottom layers of the sea. Seeds are taken in sandy zones of 20-40 m depth with swift water flow. It is known that the spat are abundant below 15 m from the sea surface. The collectors are set in February and taken out in May and June. Average density exceeds 80 spat per collector. The newly collected spat, 1 to 2 mm in shell length, are reared until September in lantern nets originally designed for pearl oysters. Young of about 5 cm in length are transferred to cone nets in September, and cultured there until they reach a marketable size of 8 to 10 cm shell length and 80 to 90 g in weight in the following May and June. The survival rate averages about 80% from the seeds of 1 to 3 cm through marketable size. In the course of fattening, fishermen remove fouling animals, select pecten by size, and change the nets several times during the period from October to December.

Pecten culture is very new, starting only in 1977. It is still operating at a trial and error stage. It is not certain whether natural seeds are sufficient to sustain possible expansion of the cultivations. Market demand for this species is still not well known. Biological surveys are also not sufficient to understand the physiology and ecology of this species, except for studies on the fluctuation in stock size and on the collection of seed.

The newly started Marine Ranching Project considers pecten to be one of the most important molluscan shellfish. This is a good

¹Nansei Regional Fisheries Research Laboratory, Ohno-Cho, Hiroshima, Japan.

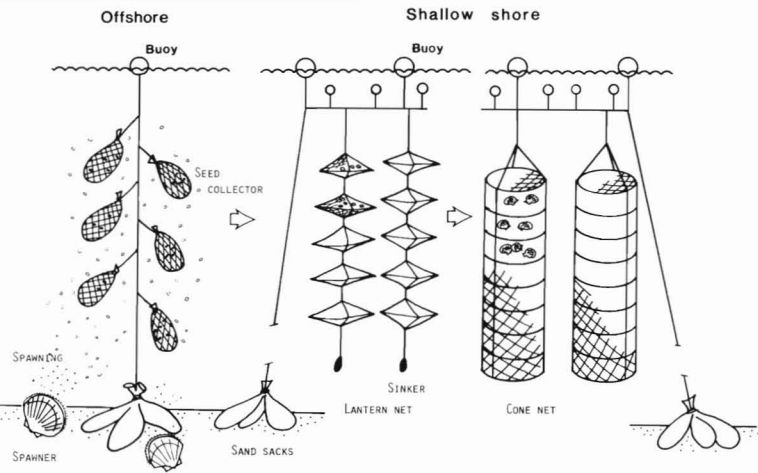

Figure 1.—Schematic representation of pecten culture. See text and Table 1 for explanation.

Table 1.—Major operations of pecten culture.

Month	Work items	Type of net	Stocking density	Size of shell (cm)	Survival ¹
February ↑ April	Prepare and hang seed collectors.				
May June July	Take seeds and bring them into lantern nets for fattening.	Lantern net (30 × 30 cm with mesh aperture of 4.5-6 mm)	Number per net is 50 1 cm seeds 40 2 cm seeds 30 3 cm seeds	1-3	100
August	Change to cone nets with 5 to 10 layers. Size selection.	Cone net (∅ 50 cm with mesh aperture of 9-15 mm)	20 ind. per layer	4-5	90
October ↓ December	Remove the fouling animals and change mesh size.	Cone net (∅ 50 cm with mesh aperture of 15-21 mm)	15 ind. per layer	5-6	80
January ↑ April May July	Fattening Harvest and market (size select and package)			8-10	70

¹Survival denotes percent after start of fattening.

opportunity for us to advance the life history of this species. Currently, the major emphasis is laid on the clarification of mechanisms to reduce stock size in the transition periods from pelagic life to settling life, and then to demersal habitat; formation of the aggregation vulnerable to exploitation; and mechanisms underlying the outbreak of the stocks. The project also aims to obtain any measure required for conservation of natural stocks which supply the seeds, and for establishment of stable and regulated stocks of spawners. The final purpose of the research activities is to find a means for utilizing the untamed sandy beaches and then for increasing production of the coastal fishermen.

LITERATURE CITED

- AYAMA, T., and M. MATOBA.
1980. On the cultivation of pecten. *Ocean Age* 12(3):53-59.
- KOBAYASHI, K.
1971. On the pecten in the coastal waters of Tottori Prefecture - II. Outbreaks in the offsea of Tottori Beach. *Bull. Tottori Pref. Fish. Exp. Stn.* 8:13-24.
- TANAKA, K.
1980. On the mass survivors of Japanese scallop, *Pecten (Notovola) albicans*, in Tateyama Bay. *Bull. Jpn. Sea Reg. Fish. Res. Lab.* 31:165-168.
- TANAKA, Y.
1977. Conditions to forming an enhancing ground of scallop, *Pecten albicans*. *Fish. Eng.* 14(1):19-24.

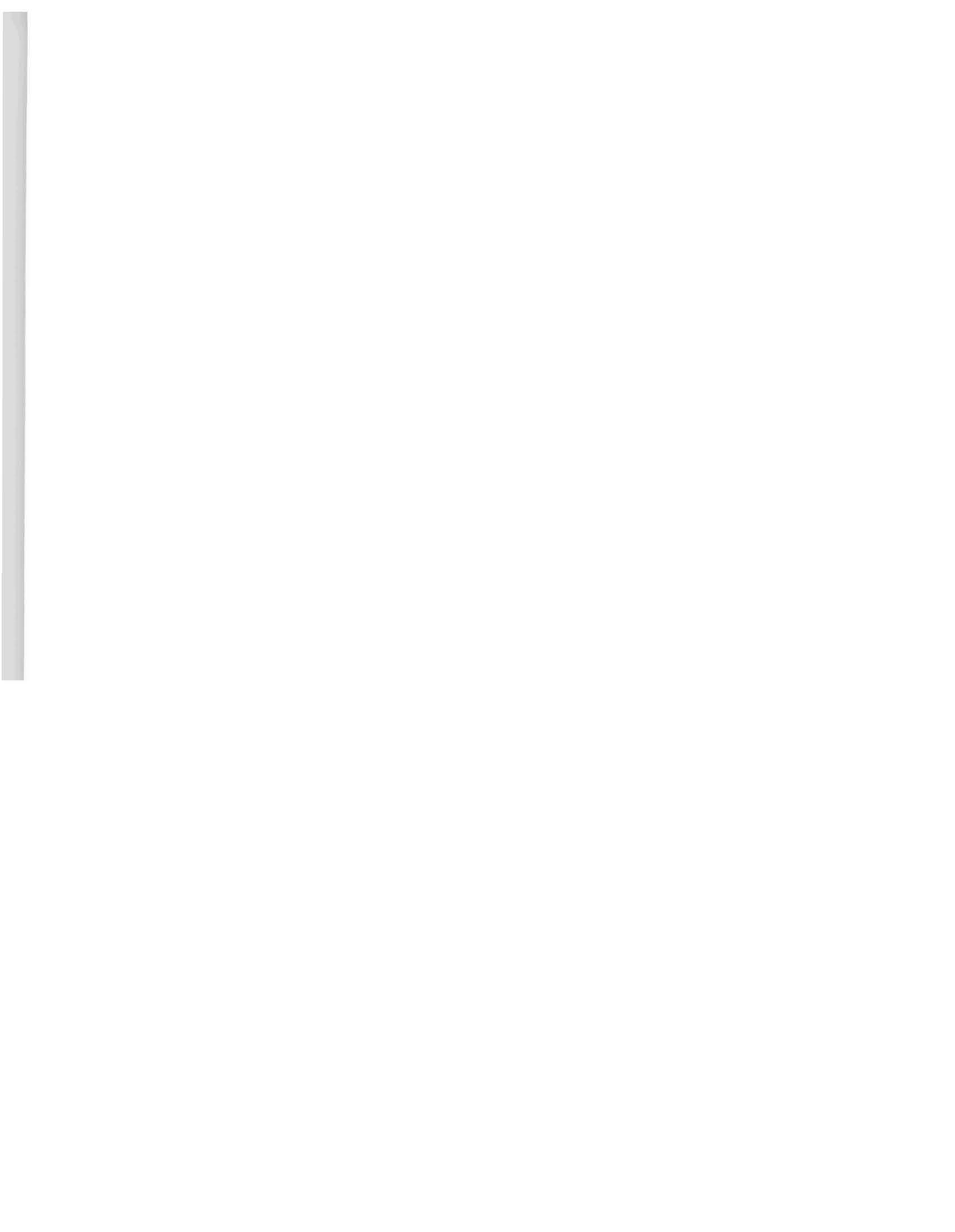

Abalone Culture in Japan

NAGAHISA UKI¹

INTRODUCTION

The production of abalone has become stable in Japan. The annual catch is approximately 5,000 tons with shell, and because of the great demand for abalone, imports are increasing (Fig. 1). Abalone, along with shrimp and sea urchins, command a high price. Abalone are very valuable in the coastal fisheries economy where the producers' price is about 5,000 yen/kg with shell. Such significant resources, so to speak "sea treasures," have been traditionally managed by rigid limitations on fishing season, harvest size, sometimes harvest methods, and limitations on total harvest, at the local level.

On the other hand, seedling production techniques for abalone are a recent advancement. An artificial supplement of seedlings to the natural resources is becoming a possibility on a commercial scale. Moreover, developments in the techniques of seaweed afforestation are improving the productivity of the fishing grounds. The introduction of these modern techniques have had many positive effects on the abalone fishery. In this paper, recent fisheries developments are discussed along with their future prospects.

PRESENT ABALONE FISHERIES

There are five important commercial species of abalone in Japan. Along the northeastern coast of Honshu and in the coastal

¹Division of Mariculture, The Ministry of Agriculture, Forestry and Fisheries, Fisheries Agency, Tohoku Regional Fisheries Research Laboratory, Shiogama, Miyagi 985, Japan.

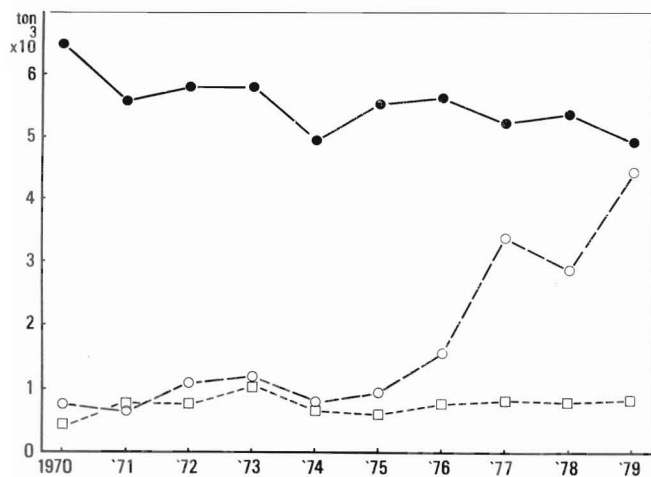

Figure 1.—Japanese total catch (indicated by closed circles) and imports of abalone (open circles indicate the amount of live, fresh, chilled and frozen abalone, and squares represent canned abalone). (After Japan Export & Import Monthly.)

waters of Hokkaido there is the cold-water species, *Haliotis discus hannai*. Along the southwestern coast of Honshu, in the coastal waters of Kyushu, and in the sea of Japan there are three warm-water species: *H. discus*, *H. gigantea*, and *H. sieboldii* (Fig. 2). Another warm-water species, *H. diversicolor*, is found in subtropical areas especially near the Izu-shichito Islands and southern islands of Kyushu. Fifty percent of the total yield of abalone is from *H. discus hannai* and the remaining 50% is divided between the warm-water species, with the production of *H. diversicolor* making up only a few hundred tons of the total.

There are regulations protecting the abalone resource from overfishing in each prefecture. Figure 3 shows the closed season and shell length limitations on harvest in the abalone producing prefectures. The season is generally closed between August and October for the cold-water species and October to mid-December for the warm-water species, primarily to protect the abalone during spawning. The legal harvest size differs among districts; it is limited to between 7.5 and 9.5 cm for *H. discus hannai*, 9 to 12 cm for the three warm-water species, and 4.5 to 5.5 cm for *H. diversicolor*. Limitations on harvest methods, times of operation, and sometimes the total catch, are decided by the fisheries cooperatives themselves. Moreover, the harvest methods themselves often serve to protect the resource. Harvesting according to local tradition, long poles with hooks in cold waters, and skin diving in

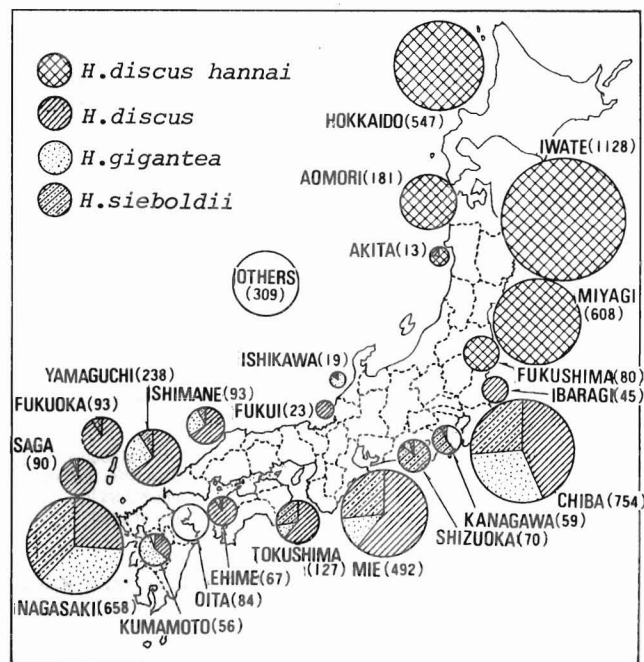

Figure 2.—Annual catch of abalone of each prefecture and their species ratio in the products. Figures in parentheses after the prefectural name are the mean catch from 1965 to 1972 shown in tons. (After Inoue 1976.)

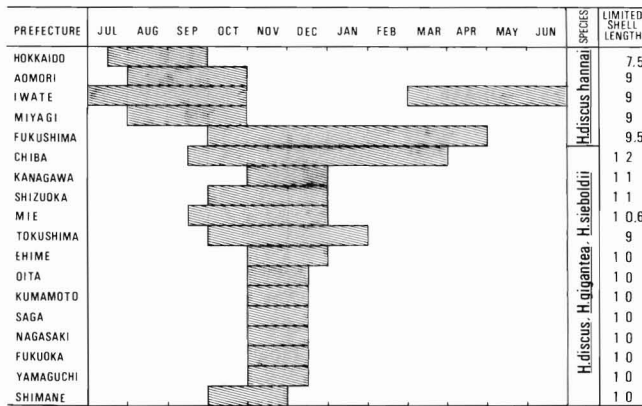

Figure 3.—The closed seasons and shell length (cm) limitations for harvesting in the main abalone producing prefectures.

warm waters, are techniques requiring skill and limit participation in the fishery.

The abalone population has carefully been preserved from excessive fishing by both law and traditional ways. The present fishery is hedged with restrictions. These restrictions have been necessary for the survival of the resource because the abalone is a benthic animal with a slow growth rate and is easily caught.

DEVELOPMENT SYSTEM OF ABALONE FISHERIES

Although the restrictions on the harvest of abalone are necessary, they present problems for artificial propagation. These restrictions are based on maintaining the natural stock and do not take into account the increased potential for production. A counter proposal, which does take into account the new capabilities, has been suggested by the team at my laboratory (Kan-no 1975), and governmental policies on abalone are gradually changing in recognition of the new potentials. Figure 4 outlines the technical system proposed by the team, and the important points of the system could be summarized as follows.

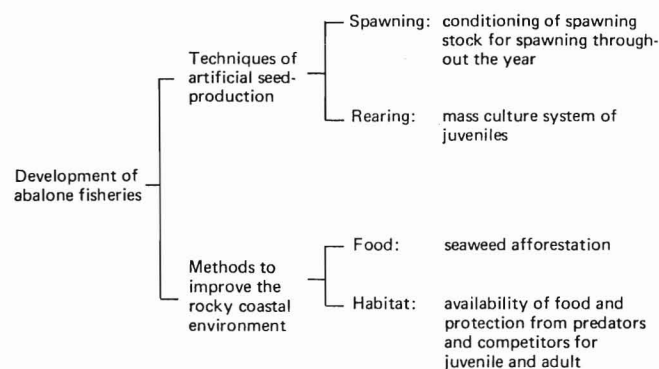

Figure 4.—Technical system for developing abalone fisheries. (After Kan-no 1975.)

Techniques of Seedling Production of Abalone

Artificial seedling production of marine animals has been developed at the national and prefectural levels in Japan. Each

Prefectural Experimental Station had a section for seedling production. About 8 yr ago, the seedling production sections were expanded and gradually reorganized into the Fisheries Farming Centers (F.F.C.). Seedling production has increased subsequent to this reorganization.

The type of seedlings produced in each F.F.C. reflect the locally significant marine products, which are mainly red sea bream and kuruma-prawn in southern Japan, and salmon and abalone in northern Japan. Iwate and Miyagi Prefectural F.F.C.'s, both located on the northeastern Pacific coast, produce the most abalone seedlings. Each F.F.C. annually produces about 1 million abalone seedlings. There are about 33 F.F.C.'s and one Research Foundation (Oyster Research Institute) producing abalone seedlings. Figure 5 depicts the annual production of seedlings in Japan from 1970 to 1979; the number of seedlings reached 6 million in 1979.

Large scale abalone production is possible because of the development of several techniques based on an increased understanding of the abalone's biology. The conditioning of adults for spawning was possible after the physiological mechanism of maturation (Kikuchi and Uki 1974a) became clear. Spawning techniques using ultraviolet irradiation (Kikuchi and Uki 1974b) and handling procedures for the larvae followed clarification of the larvae's development related to temperature (Seki and Kan-no 1977, 1981) and after investigation of the phenomenon of larval settlement on adult mucus trails (Seki 1979). Details on the current commercial processes have been introduced by Grant (1981).

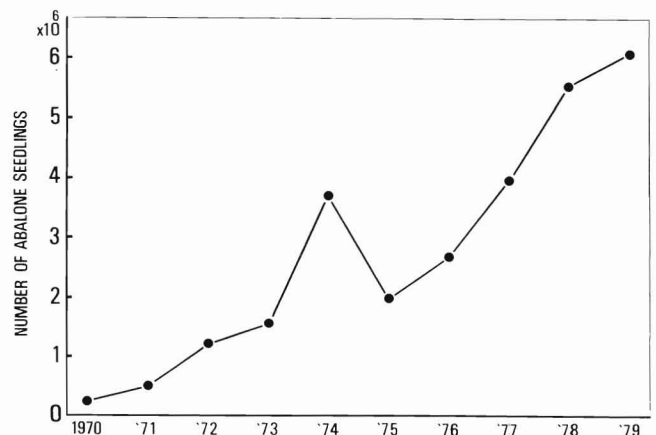

Figure 5.—Annual production of artificially produced abalone seedlings in Japan.

Improvement of Nutritional Environment

Distribution of the genus *Haliotis* corresponds with the distribution of the order Laminariales except for the coldest districts of eastern Hokkaido on the Okhotsk Sea. Abalone eat seaweed and especially prefer the order Laminariales. Uki (1981) has shown that the best growth of *H. discus hannai* is with the genus *Laminaria*. The food value of marine algae in northeastern Japan for the growth of *H. discus hannai* is shown in Figure 6. In cold areas the main food for abalone are *Laminaria* spp. and *Undaria pinnatifida*. *Eisenia bicyclis*, *Ecklonia cava*, and *U. pinnatifida* are the important foods in warm areas.

Annual net production of these algae is about 10 kg wet weight/m² in a fertile bed and around 4 kg wet weight/m² in a

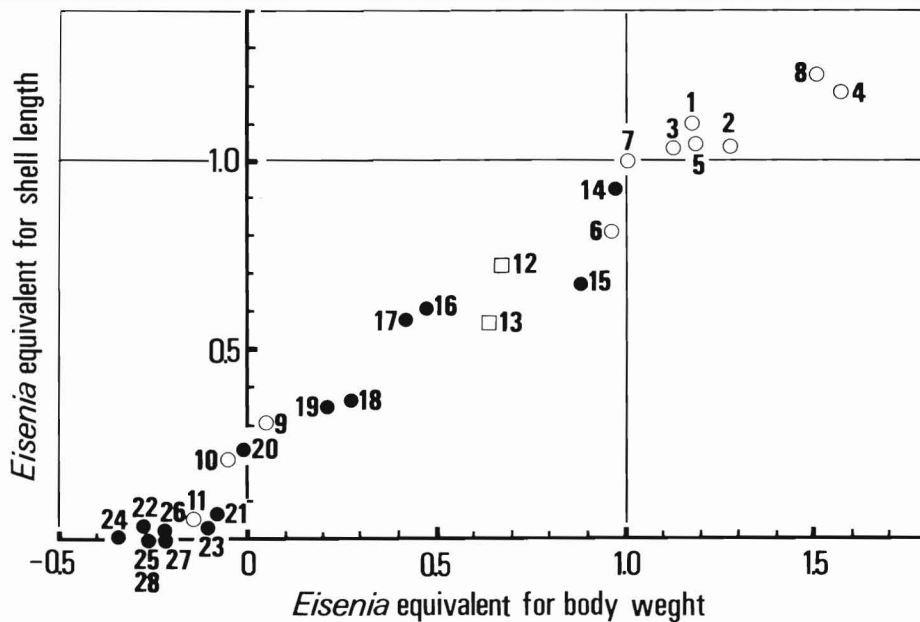

Figure 6.—Relative food values (Eisenia-equivalent) of seaweeds. Using the growth rate of *Haliotis discus hannai* fed on a diet of *Eisenia bicyclis* as a standard. (After Kikuchi and Uki 1981.) 1: *Laminaria japonica*, 2: *L. japonica* f. *membranacea*, 3: *L. religiosa*, 4: *L. diabolica*, 5: *L. angustata* var. *logissima*, 6: *Kjellmaniella gyrata*, 7: *Eisenia bicyclis*, 8: *Undaria pinnatida*, 9: *Sargassum ringgoldianum*, 10: *Dictyopterus divaricata*, 11: *Pachydictyon coriaceum*, 12: *Codium* sp., 13: *Ulva pertusa*, 14: *Porphyra yezoensis*, 15: *Solieria mollis*, 16: *Grateloupia* sp., 17: *Rhodymenia intricata*, 18: *Neodilsea yendoana*, 19: *Gelidium amansii*, 20: *Acrosorium* sp., 21: *Grateloupia elliptica*, 22: *Plocamium telfairiae*, 23: *Chrysmenia wrightii*, 24: *Symphyocladia latiuscula*, 25: *Pikea californica*, 26: *Callophyllis crispata*, 27: *Schizymenia dubyi*, 28: *Corallinoideae*. Open circle, square, and closed circle indicate Phaeophyta, Chlorophyta, and Rhodophyta, respectively.

common bed. There are many herbivores besides abalone like sea urchin, snail, limpet, sea hare, and others which depend on algae as a main food source. The usual population density of these herbivores is approximately 100 to 200 g wet weight/m². The dominant herbivore in a good abalone fishing ground is *Haliotis* spp., which should occupy 60% of all herbivores. A poor ground will be dominated by sea urchins and/or small snails.

An infralittoral area that is devoid of large kelp, such as that of the order Laminariales, and is dominated by a dense mat of crustose coralline algae, is called an "Isoyake" in Japanese and "Pink Rock" in English. These areas are like deserts and the animals that live in them have little commercial value because of their lack of meat and poor gonadal condition. Fishermen cannot catch and sell them because they have no commercial value. We often have this phenomenon in the coastal waters inhabited by *H. discus hannai*.

In recent years, this phenomenon of a sea desert has been ascribed to an inordinately large population of grazers. There are over 300 g wet weight/m² in an Isoyake area and continuous grazing, especially by the dominant sea urchin, *Strongylocentrotus nudus*, cuts the growing young fronds of seaweeds. In an Isoyake area, the equilibrium between plants and grazers is not beneficial to the fishermen. The cycle between the barer area of an Isoyake and the poor harvest by fishermen will not change without intervention.

A marine afforestation technique has been developed to make areas that have been overgrazed more productive (summarized by Kito et al. 1979). The technique consists of two parts. First, the planting of *Laminaria religiosa*, which has three main functions: Supplying diet to grazers, reducing grazing pressure on the rocky

bottom by providing alternative food, and spreading spores on denuded rock. Second, the grazers are regularly harvested to limit their numbers. After afforestation, a *L. religiosa* community, 6 to 8 kg wet weight/m² in annual net production, will be produced the following year in an area that was previously denuded. After the area has been reforested, a calculated number of abalone seedlings are introduced onto the fertile ground.

Results of this experiment substantiated the hypothesis that the Isoyake areas are caused by the overgrazing of herbivores. Further information on plant succession in shallow coastal areas has resulted from this experiment and observations. Figure 7 shows the resulting vegetative cover at different grazing pressures. For example, since Laminariales is a favorite food for grazers it is the first to decrease when grazing pressure increases. Controlling herbivorous feeding pressure is the key to managing abalone farming.

Arayabu Bay of Enoshima Island, located off Ojika Peninsula in Miyagi Prefecture, is one of the farms where experimental afforestation was conducted from 1969 to 1974. Before the trials, the bay area of 2.3 ha had no commercial value since it was a typical Isoyake. However, the bay has continuously produced 3 tons of abalone per year since the afforestation experiment. Since the experiment, the Enoshima Fishery Cooperative has taken over management of the bay itself utilizing methods developed during the experiment.

FARMING OF SEEDLINGS

Abalone seedling production remained on a small scale, both in quality and quantity, before the improvement of hatcheries. How-

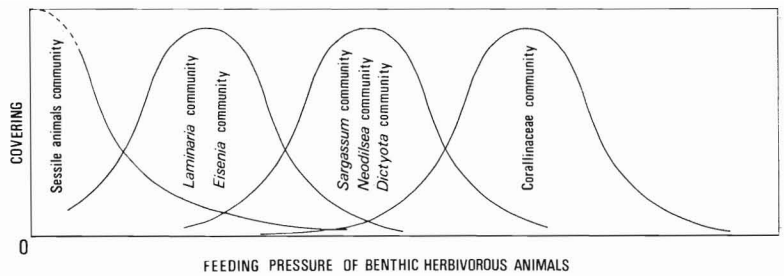

Figure 7.—The relation between feeding pressure of benthic herbivorous animals and the covering of a shallow reef of the Sanriku Coast. (After Kikuchi and Uki 1981.)

ever, several important experiments were performed to examine the possibility of abalone farming in this exploratory period. It has gradually become clear that release of small size seedlings, under 3 cm, has a low recovery catch a few years later. It seems that a larger seedling around 4 to 6 cm must be used to increase abalone population. For example, in Kanagawa Prefecture the *H. gigantea* seedlings larger than 4 cm showed a good survival rate of 70 to 80% after a year release (Fig. 8). Funka Bay, which did not previously have an abalone fishery, has been converted into a new fishing ground by the transplantation since 1950 of naturally produced large seedlings of 4 to 6 cm shell length. There is a clear quantitative relationship between transplantation and catch (Saito 1979). It is our understanding that releasing 10,000 large seedlings will result in a 0.5 to 1 ton catch of abalone at harvest time in these successful trials.

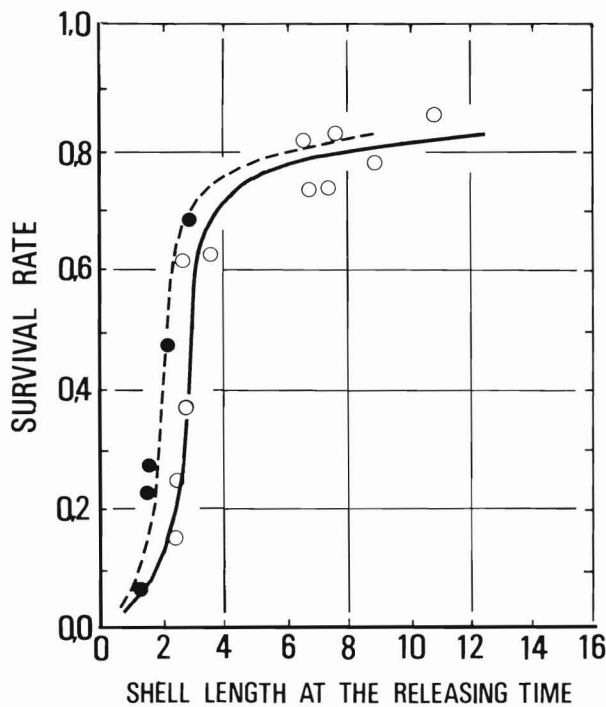

Figure 8.—The relation between the annual survival rate of seedlings of the abalone, *Haliotis gigantea*, and shell size (cm) at releasing time. Data were obtained from tagging experiments at Kanagawa Prefecture after 1 yr release. Open and closed circles indicate data from natural beds and the nursery beds made of boulders, respectively. (After Inoue 1977, fig. 10G.)

IMPROVEMENT OF HABITAT

The decrease of seedlings in the natural bed is mostly caused by predation by carnivores. Some fish, octopus, sea stars, and crabs are well known as predators of abalone. Concrete blocks engraved with slits, and baskets filled with boulders, are designed to protect the seedlings from attack in the juvenile nursery grounds (Fig. 9). Some of these measures are reflected in the increased survivorship for the nursery bed population as shown in Figure 8. According to the data collected by Inoue (1977), a seedling reared in the nursery ground will have the same survivorship as a seedling 1 cm larger in a natural bed. Since it is possible to release a smaller seedling and get a similar harvest, there is a saving for the system.

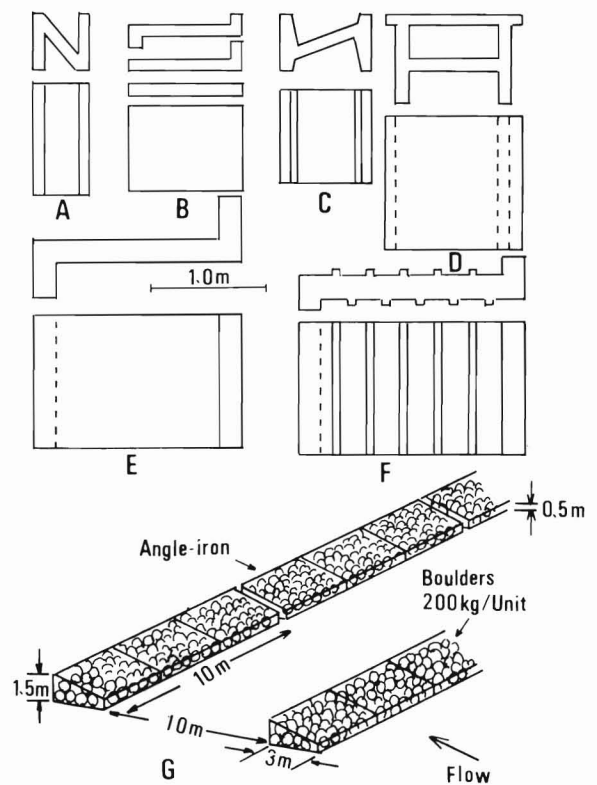

Figure 9.—Examples of block units for constructing abalone farming grounds. (After Inoue 1980.)

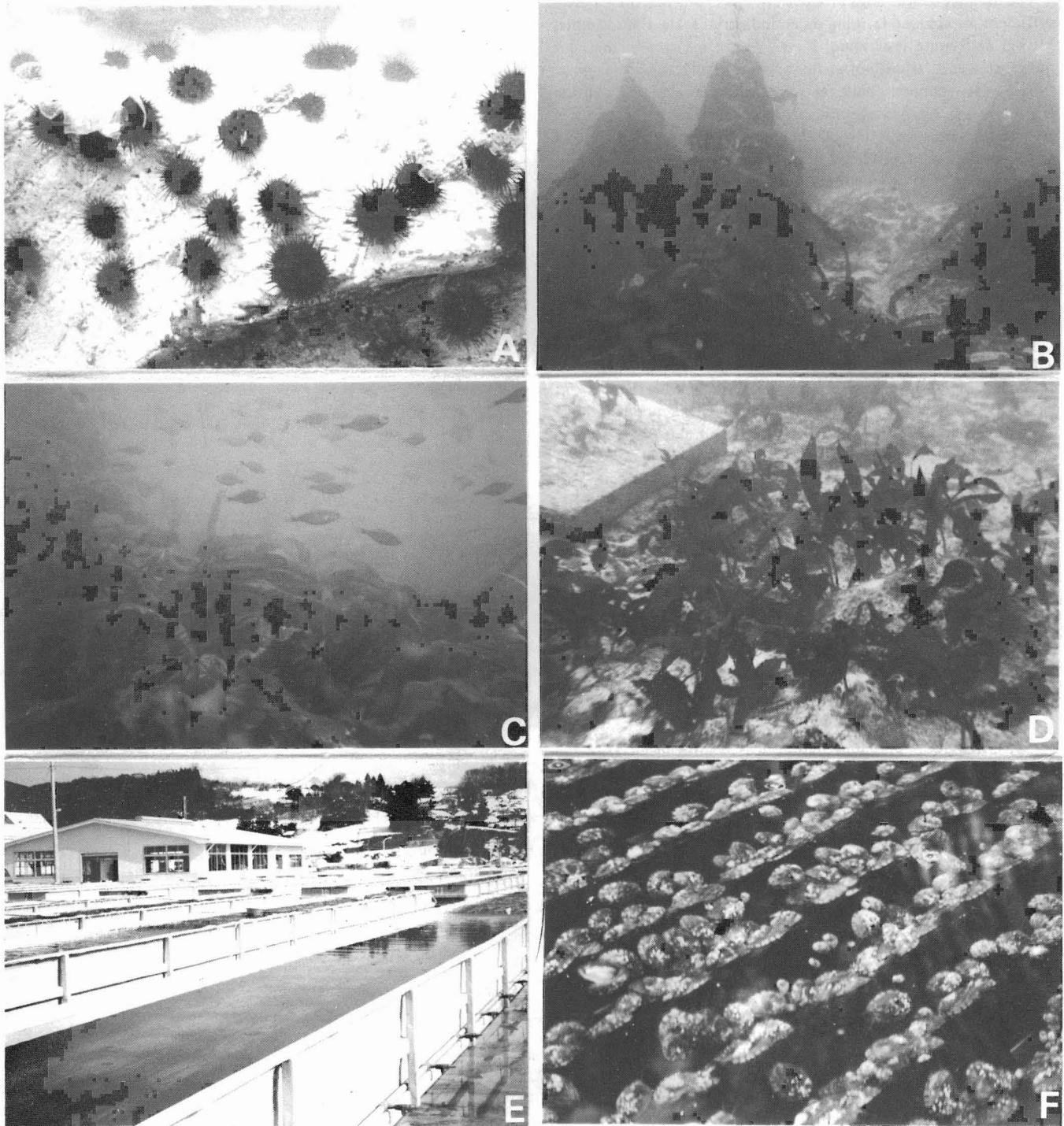

Figure 10.—Several examples of cold water marine beds and the practice of abalone seedling production. A: Typical Isoyake caused by continuous feeding of herbivores, especially sea urchins (*Strongylocentrotus nudus* in this case) at Enoshima Island in Miyagi Prefecture. B: A view of the *Laminaria* afforestation system during summer season at Arayabu Bay on Enoshima Island. C: Fertile bed of *Laminaria religiosa* community converted by the artificial afforestation technique. Thirty kg/m² of standing crop of *L. religiosa* in wet weight is recorded in the densest community. D: Young community of *Eisenia bicyclis* gradually occupying the bottom of Arayabu Bay on Enoshima Island instead of the usual *L. religiosa* community. E: The water way for abalone juvenile production at Iwate Prefectural Fisheries Farming Center. F: The abalone seedlings of *Haliotis discus hannai* attached on polyvinylchloride plates.

FUTURE PROSPECT OF ABALONE CULTURE

The size of the seedlings is the key to getting a high rate of recovery. F.F.C.'s usually deliver their seedlings to the coopera-

tives at the size of 2 to 3 cm after 1 yr of rearing. Cooperatives usually rear the abalone in intermediate culture for 1 yr until the seedlings are 4 to 6 cm. After intermediate culture, the seedlings are released. Figure 10 illustrates the practice of abalone seedling production and shows several examples of cold water marine beds.

The number of seedlings produced in F.F.C.'s is reaching a level sufficient for abalone farming on an industrial scale. For example, Miyagi and Iwate Prefectural F.F.C.'s have a target in the near future of 4 and 10 million abalone, respectively.

The next technical challenge for boosting abalone production will be to get a larger seedling within a shorter period of time. Hybridizing new varieties of abalone and the development of artificial diets are considered to be the main subjects to solve.

Improving basal production in fishing grounds was attained by the development of the genus *Laminaria* afforestation technique in a cold-water area; however we also have Isoyake in warm-water areas. A new project, aimed at the development of *Eisenia bicyclis* afforestation techniques, has been proposed as a part of the Marine Ranching Project promoted by the Ministry of Agriculture, Forestry, and Fisheries.

The perennial *E. bicyclis* community, which is often associated with *Eklonia cava*, is superior to annual or biennial *Laminaria* communities in terms of continuous productivity. *Laminaria religiosa* distributed in the main abalone fishing grounds is non-productive during the winter while an *Eisenia* and *Eklonia* community is able to give food in all seasons and these plants have a relatively long life of about 7 to 8 yr. Recently the bottom of Arayabu Bay of Enoshima Island, where herbivorous feeding pressure has been artificially controlled, is gradually being occupied by an *E. bicyclis* community. It will probably give a hint on developing *Eisenia* afforestation techniques in warm-water areas.

With the tools in hand to improve the abalone's habitat and produce large numbers of seedlings, the main obstacles to increasing the harvest of abalone are overcome.

ACKNOWLEDGMENTS

I wish to express my appreciation to Hisashi Kan-no, Director of the Mariculture Division of the Tohoku Regional Fisheries Research Laboratory, for his valuable suggestions and to Shogo Kikuchi, Chief of Fish and Shellfish Section of the Laboratory, for discussions of the problems. I am also indebted to Brian Hovis, a researcher at the Oyster Research Institute, for his kindness in correcting the manuscript.

LITERATURE CITED

- GRANT, J. F.
1981. Abalone culture in Japan: Development and current commercial practice. *Tasmanian Fish. Res.* 23:2-17.
- INOUE, M.
1976. Abalone. *In* Jpn. Fish. Coop. Assoc. (supervisor), Aquaculture hand book, Vol. 1, p. 19-61.
1977. Propagation in the coast of Japan—On the propagation of the abalone. *Mar. Sci./Monthly* 9:18-25.
1980. Y. Oshima and T. Tamura (supervisors), Fisheries engineering hand book, p. 151-161. Midori Shobo, Tokyo.
- KAN-NO, H.
1975. Recent advances in abalone culture in Japan. *In* Proc. First Int. Conf. Aqua. Nutr., p. 195-211. Univ. Delaware, Lewes, U.S.A.
- KIKUCHI, S., and N. UKI.
1974a. Technical study on artificial spawning of abalone, genus *Haliotis* I. Relation between water temperature and advancing sexual maturity of *Haliotis discus hannai* Ino. *Bull. Tohoku Reg. Fish. Res. Lab.* 33:69-78.
1974b. Technical study on artificial spawning of abalone, genus *Haliotis* II. Effect of irradiated sea water with ultraviolet rays on inducing to spawn. *Bull. Tohoku Reg. Fish. Res. Lab.* 33:79-86.
1981. Productivity of benthic grazers, abalone and sea urchin in *Laminaria* beds. *Suisangaku Ser. No. 38, Seaweed Beds*, p. 9-23. Koseisha Koseikaku, Tokyo.
- KITO, H., S. KIKUCHI, and N. UKI.
1979. Seaweed as nutrition for seabed marine life technology for artificial marine forests. *In* Int. Symp. Coast. Pacific Mar. Life, p. 55-66. Western Washington Univ., Bellingham, U.S.A.
- SAITO, K.
1979. Studies on propagation of Ezo Abalone, *Haliotis discus hannai* Ino—I Analysis of the relationship between transplantation and catch in Funka Bay Coast. *Bull. Jpn. Soc. Sci. Fish.* 45:695-704.
- SEKI, T.
1979. An advanced biological engineering system for abalone seed production. *In* Int. Symp. Coast. Pacific Mar. Life, p. 45-54. Western Washington Univ., Bellingham, U.S.A.
- SEKI, T., and H. KAN-NO.
1977. Synchronized control of early life in the abalone, *Haliotis discus hannai* Ino, Haliotidae, Gastropoda. *Bull. Tohoku Reg. Fish. Res. Lab.* 38:142-153.
1981. Observations on the settlement and metamorphosis of the veliger of the Japanese abalone, *Haliotis discus hannai* Ino, Haliotidae, Gastropoda. *Bull. Tohoku Reg. Fish. Res. Lab.* 42:31-39.
- UKI, N.
1981. Food value of marine algae of Order Laminariales for growth of the abalone, *Haliotis discus hannai*. *Bull. Tohoku Reg. Fish. Res. Lab.* 42:19-29.

Osmoregulation in Marine Bivalves

KOJI WADA¹

Marine culture of edible bivalves, as well as nonedible ones such as the pearl oyster, has long been an important industry in the coastal fisheries of Japan. An annual production of more than 200,000 tons (with shell) has been maintained for more than 10 yr. Most bivalves are cultured intensively by using hanging methods. However, the recent trend of increasing production within a limited area with high stocking density is accompanied by an increase in the mortality of bivalves and lowered quality of the products. The widely adopted hanging method involves the confinement of bivalves in a pocket or basket net, which forces the bivalves to live quite differently from the environment of their natural habitat.

Some species, such as oysters, have developed physiological and metabolic functions to adapt themselves to severe changes, such as in salinity and temperature, in their natural environment. On the other hand, species such as scallops have not developed such adaptations due to the more mild environmental conditions of their habitat. This paper deals with the relationship between habitat and the ability to osmoregulate in some species of bivalves with special reference to free amino acids found in their body fluids.

MATERIALS AND METHODS

The present study was carried out with clams (*Saxidomus purpuratus*), mussels (*Mytilus edulis*), oysters (*Crassostrea gigas* and *Pinctada fucata*), and scallops (*Chlamys nobilis*). After being collected, the bivalves were kept in net baskets at Ago Bay, Mie Prefecture, for at least 1 wk prior to the experiment.

Individual Ion Analysis

Major elements such as sodium, potassium, calcium, and magnesium in the extrapallial fluid of *Mytilus edulis* and environmental seawater were determined using atomic absorption spectrometry. Concentrations of chloride and sulphate were measured volumetrically and gravimetrically, respectively. Details of sampling methods and analytical techniques were described in a previous paper (Wada and Fujinuki 1976).

Amino Acid Analysis

Each of the extrapallial fluids collected from *Saxidomus*, *Mytilus*, *Crassostrea*, *Pinctada*, and *Chlamys* was divided into two equal portions. One was evaporated and then hydrolyzed in an ampoule with 6N hydrochloric acid at 110°C for 22 h. The other was dialyzed by cellophane tube and the residue was hydrolyzed under the same conditions. Amino acids in the hydrolysate of the untreated extrapallial fluid and the residue of dialysis were deter-

mined with an amino acid analyzer (Hitachi, KLA-5²), and the amount of amino acids was calculated on the dialysate.

Determination of Osmotic Pressure

In order to compare the osmoregulatory ability in the marine bivalves, the following experiment was conducted using saltwater at six levels of salinity: 1) Normal seawater, 2) 75% seawater, 3) 50% seawater, 4) 25% seawater, 5) 150% seawater, and 6) 200% seawater. The salinity level was adjusted by adding either salt- or freshwater to normal seawater. A plug was inserted between shell valves of each bivalve to help the experimental medium come freely into the mantle cavity. They were placed in six plastic tanks filled with the experimental seawater. The experimental seawater, mantle cavity fluid, haemolymph, and extrapallial fluid were collected in centrifuge tubes at 3, 23, and 48 h after the bivalves were immersed in the experimental medium, and centrifuged to remove cells and debris. The osmotic pressure of the media and body fluids was measured using an Advanced Model 3C11 Cryomatic Osmometer.

RESULTS

The composition of major elements in the extrapallial fluid of *Mytilus*, shown in Table 1, indicates that concentrations of sodium, chlorine, and magnesium in the fluid were similar to those of the environmental medium. They appear to be in an ionized form. Similar results have been reported on extrapallial fluid and haemolymph of marine bivalves (Schoffeniels and Gilles 1972; Wada and Fujinuki 1976).

The amino acid composition differed significantly between the untreated extrapallial fluid and its dialysate (Table 2). All of the taurine was able to pass through a cellophane membrane and appears to be in free and peptide forms. On the contrary, most of the other amino acids were found to be in forms of protein and complex: *Mytilus* (3.7 $\mu\text{mol/ml}$), *Crassostrea* (1.1 $\mu\text{mol/ml}$), *Pinctada*

²Reference to trade names or commercial firms does not imply endorsement by the National Marine Fisheries Service, NOAA.

Table 1.—Comparison of main element content in the untreated (A) extrapallial fluid and its dialysate (B) of *Mytilus edulis* (ppm).

Element	Seawater	Extrapallial fluid	
		A	B
Na	8,980	9,060	9,060
K	291	388	388
Ca	327	334	334
Mg	1,120	1,070	1,070
Cl	17,230	17,090	17,090
SO ₄	2,402	2,856	2,605

¹Oumura Branch of National Research Institute of Aquaculture, 19-2 Kushi-magou, Oumura City, Nagasaki-Ken, Japan.

Table 2.—Comparison of amino acids in the untreated (A) extrapallial fluid and its dialysate (B) of marine bivalve molluscs ($\mu\text{mol}/100\text{ ml}$).

Species	<i>Saxidomus purpuratus</i>		<i>Pinctada fucata</i>		<i>Mytilus edulis</i>		<i>Crassostrea gigas</i>		<i>Chlamys nobilis</i>	
	A	B	A	B	A	B	A	B	A	B
Cysteic acid	9.2		20.7	14.8	50.3	9.4	80.7	2.3	8.2	0.2
Taurine	43.6	43.6	1,486.1	1,486.1	370.3	370.3	105.0	105.0	8.6	8.6
Aspartic acid	278.4	0.3	795.0	71.3	245.1	15.5	436.8	4.6	195.7	0.2
Threonine	36.4	0.1	439.0	6.7	91.8	6.9	160.5	1.0	56.0	
Serine	189.5	0.3	396.1	7.2	88.7	12.1	117.3	1.1	55.8	
Glutamic acid	75.1	0.7	750.1	42.1	242.1	21.7	305.2	4.4	131.6	0.4
Proline	12.0	0.4	152.6	2.7	41.5	2.4	64.1	1.8	22.4	0.8
Glycine	74.1	0.9	561.7	53.2	193.2	50.6	288.1	6.2	305.1	11.9
Alanine	33.9	0.2	559.8	58.7	158.4	24.3	226.5	7.4	73.8	0.1
Cystine			53.9							
Valine	29.7	0.1	429.2	16.8	138.3	6.5	138.4	5.0	47.7	0.2
Methionine	+		123.6	1.8	24.8		45.8	+	10.9	0.1
Isoleucine	22.0	0.1	398.3	6.4	94.3	2.6	160.2	3.5	44.5	0.1
Leucine	30.9	0.1	491.4	9.0	118.1	3.1	239.7	4.7	47.5	0.2
Thyrosine	+		147.7	+	25.4	4.1	54.1		14.9	
Phenylalanine	16.6	0.1	252.0	+	86.0	1.1	100.6	1.7	14.9	
Lysine	35.2	0.1	880.3	13.0	143.8	23.0	42.6	3.3	67.0	1.0
Histidine	526.8	0.1	227.8	72.4	148.6	2.9	300.9	1.4	185.8	0.3
Arginine	49.6	0.2	308.0		51.1	2.2	115.4		39.7	

(14.9 $\mu\text{mol}/\text{ml}$), and *Chlamys* (0.09 $\mu\text{mol}/\text{ml}$). This significant difference in taurine concentration seems to reflect the difference in habitat of these bivalves. In another study (Wada 1982), taurine was not found in the fluid of freshwater species.

Figure 1 shows the osmotic pressure of the mantle cavity fluid, haemolymph, and extrapallial fluid collected at 2-5 h for *Saxidomus* and *Chlamys*, and at about 24 h for *Mytilus* after immersion in the experimental medium. At those respective hours, *Saxidomus* began to die in 200% (osmotic pressure = 2,000 mOsm/kg) and 150% (osmotic pressure = 1,480 mOsm/kg) seawater, *Chlamys* in any external medium except for normal (osmotic pressure = 940 mOsm/kg) and 75% (osmotic pressure = 710 mOsm/kg) seawater, and *Mytilus* in 200% seawater.

The body fluids of these bivalves remained isosmotic with 75% seawater for a few hours after they were placed in the 75% seawater medium. However, the body fluids of *Saxidomus* became hyperosmotic in more diluted media (Fig. 1), where the clam could live for at least 24 h. In *Mytilus*, the body fluids were isosmotic in the range of 150% (osmotic pressure = 490 mOsm/kg) seawater but became hyperosmotic in 25% (osmotic pressure = 240 mOsm/kg) seawater (Fig. 1). The mussel tolerated a wider range of external salinities down to 25% seawater during the experiment. On the other hand, *Chlamys* could withstand salinities only down to 75% seawater. When scallops became unable to acclimate themselves to external media of high or low salinity, the osmotic pressure of the haemolymph and extrapallial fluid decreased in higher salinities and increased in diluted media, as shown in Figure 1, and they died.

When bivalves were put in the diluted media, *Saxidomus* expanded their volume and the edge of the mantle pulp of *Mytilus* and *Saxidomus* closed to prevent the external medium from coming into the mantle cavity. Consequently, in spite of the valves being kept open in the experiment, the salinity inside the mantle cavity of *Saxidomus* and *Mytilus* was maintained at values higher than those measured in 50% and 25% seawater. Moreover, they closed their valves tightly and were able to temporarily isolate themselves from the external medium. *Chlamys* did not close their valves and mantle edge tightly.

DISCUSSION

Understanding osmoregulatory mechanisms of marine molluscs in relation to their habitat provides important knowledge for development of hanging culture techniques which confine the organisms in baskets. Many studies have demonstrated that marine molluscs are osmoconformers and their body fluids are isosmotic under a wide range of external salinities. Bivalves appear to regulate the ionic and free amino acid concentrations of their body fluids against changes in external salinities to a certain extent; they also tolerate sudden changes in the salinity of their environmental medium by closing their shell valves tightly (Camien et al. 1951; Duchâteau et al. 1952; Gilles 1972; Robertson 1964; Schoffeniels and Gilles 1972).

The clam, *Saxidomus purpuratus*, is a soft bottom burrower. It burrows deeply in the mud and has well-developed siphons. In natural conditions, deep burrowers such as *Saxidomus* and *Panopea* seldom encounter a shift in salinity and temperature. However, when they are cultivated in a basket hanging from a raft they die at temperatures higher than 20°C. Most of them can only survive under 490 mOsm/kg at most for 1 d. They close their valves tightly and can tolerate salinity changes for a few days. Attached surface dwellers such as *Mytilus*, *Crassostrea*, and *Pinctada* which live in an intertidal zone must endure a wide range of external salinities and temperatures; for example, *Mytilus edulis* and *Crassostrea gigas* can live even in environmental media of < 240 mOsm/kg for a long period. Similarly, the attached surface dwellers isolate themselves from the medium by closing their shell valves. On the other hand, the scallop *Chlamys nobilis*, an unattached surface dweller, lives freely or attaches only weakly by a byssal thread on the bottom surface. The swimming ability of scallops such as *Chlamys* and *Pecten* makes it possible for them to escape and protect themselves from predators or sudden disturbances in environmental conditions. They can swim by clapping their shell valves, but cannot close the valves tightly. Consequently, the unattached surface dwellers are the weakest among the bivalves in their ability to osmoregulate; for example, *Chlamys nobilis* cannot live in media < 710 mOsm/kg.

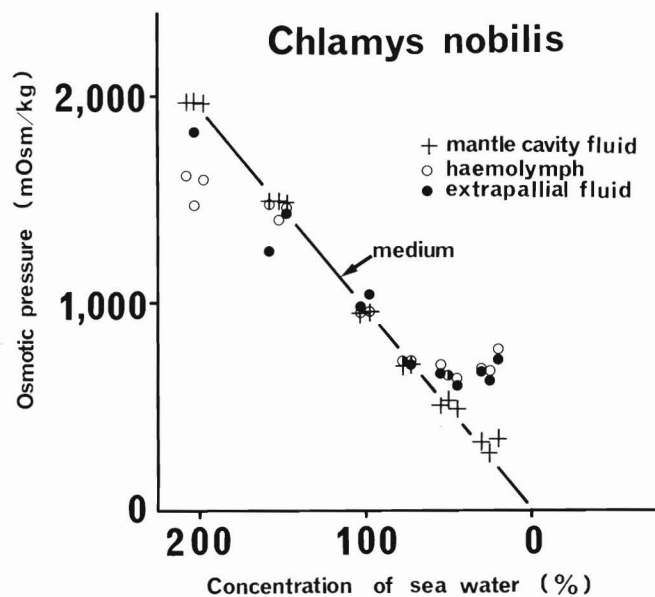
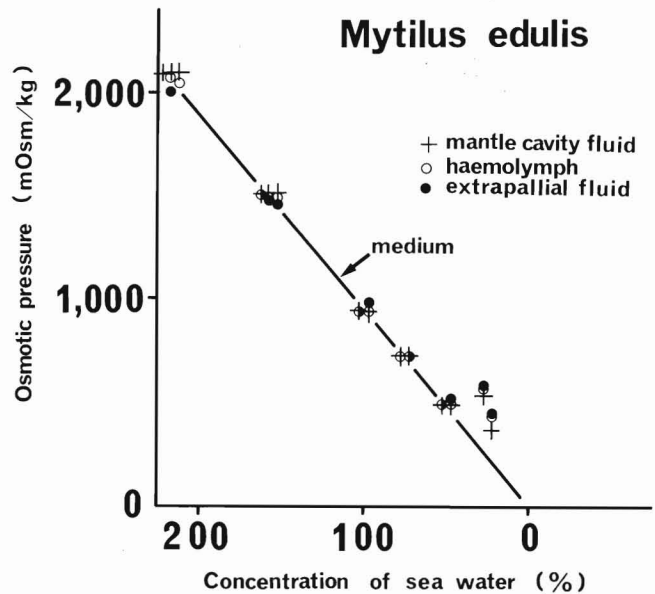
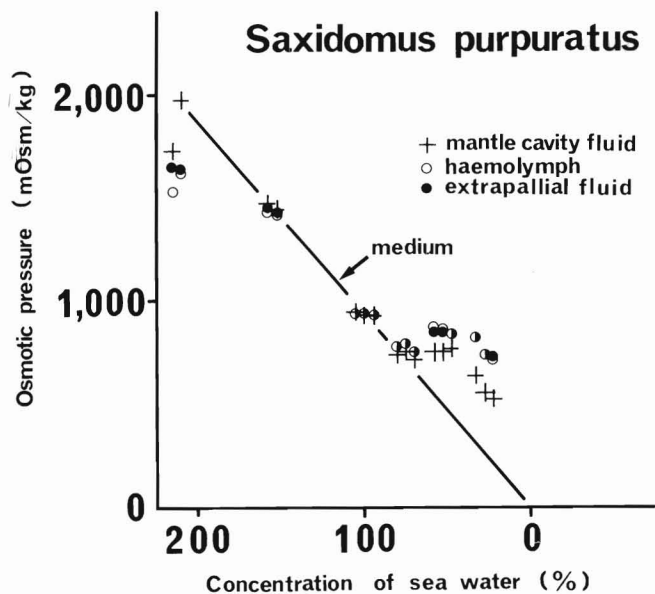

Figure 1.—Osmotic equilibrium and disequilibrium between the body fluids and external media in the processes of acclimation and death.

The amount of free amino acids in the extrapallial fluid appears to differ significantly among soft bottom burrowers, attached surface dwellers, and unattached surface dwellers. It is noted that the attached surface dwellers have higher amounts of free amino acids in their body fluids than the others, but have similar amounts of the main inorganic elements to those of the environmental medium.

The above-mentioned consideration suggests that free amino acids, especially taurine, may be involved in the osmoregulation of body fluids of marine bivalves. The ability to tolerate an osmotic stress appears to depend on physiological and biochemical characteristics adapted to particular habitats. Free amino acid analyses of the body fluids obtained from 13 species of marine bivalves under various salinities are being conducted in order to obtain further information on the role of free amino acids in osmoregulation.

ACKNOWLEDGMENTS

The author expresses his sincere thanks to S. Funakoshi and T. Suzuki of the National Research Institute of Aquaculture for their help in the measurement of osmotic pressure.

LITERATURE CITED

- CAMIEN, M. N., H. SARLET, G. DUCHÂTEAU, and M. FLORKIN.
1951. Non-protein amino acids in muscle and blood of marine and fresh water Crustacea. *J. Biol. Chem.* 193:881-885.
- DUCHÂTEAU, G., H. SARLET, M. N. CAMIEN, and M. FLORKIN.
1952. Acides aminés non protéiniques des tissus chez les Mollusques Lamellibranches et chez les Vers. Comparaison des formes marines et des formes dulcicoles. *Arch. Int. Physiol.* 60:124-125.
- GILLES, R.
1972. Osmoregulation in three molluscs: *Acanthochitona discrepans* (Brown),

- Glycymeris glycymeris* (L.) and *Mytilus edulis* (L.). Biol. Bull. (Woods Hole) 142:25-35.
- ROBERTSON, J. D.
1964. Osmotic and ionic regulation. In Physiology of mollusca I, p. 283-308. Acad. Press, N.Y.
- SCHOFFENIELS, E., and R. GILLES.
1972. Ionregulation and osmoregulation in mollusca. In Chemical zoology VIII. Mollusca, p. 393-398. Acad. Press, N.Y.
- WADA, K.
1982. Pearl—its formation and idenfication. Gem. Assoc., All Japan Press, Tokyo.
- WADA, K., and T. FUJINUKI.
1976. Biomineralization in bivalve molluscs with emphasis on the chemical composition of the extrapallial fluid. In The mechanisms of mineralization in the invertebrates and plants, p. 175-190. South Carolina Univ. Press, Columbia.